

R&S® RTC1000

Digital Oscilloscope

User Manual

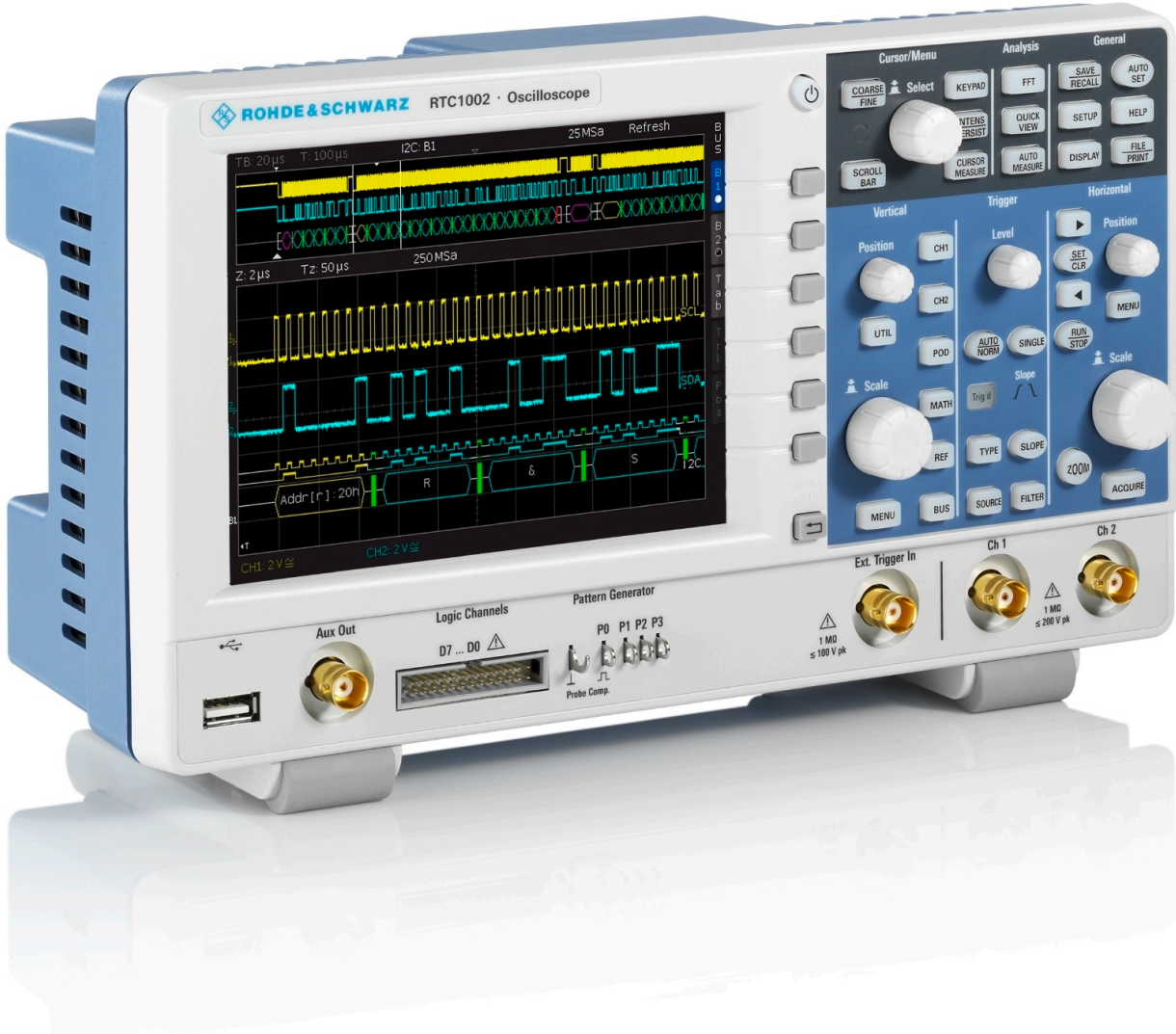

1335735202
Version 06

ROHDE & SCHWARZ
Make ideas real



This document describes the following R&S RTC1000 models:

- R&S®RTC1000 (1335.7500K02)

© 2022 Rohde & Schwarz GmbH & Co. KG
Muehldorfstr. 15, 81671 Muenchen, Germany
Phone: +49 89 41 29 - 0
Email: info@rohde-schwarz.com
Internet: www.rohde-schwarz.com

Subject to change – data without tolerance limits is not binding.

R&S® is a registered trademark of Rohde & Schwarz GmbH & Co. KG.

Trade names are trademarks of the owners.

1335.7352.02 | Version 06 | R&S®RTC1000

Throughout this manual, products from Rohde & Schwarz are indicated without the ® symbol, e.g. R&S®RTC1000 is indicated as R&S RTC1000.

Contents

1	Safety Information.....	7
1.1	Safety Instructions.....	7
1.2	Korea Certification Class A.....	8
2	Documentation Overview.....	9
2.1	Manuals and Instrument Help.....	9
2.2	Data Sheet and Brochure.....	10
2.3	Calibration Certificate.....	10
2.4	Release Notes, Open Source Acknowledgment.....	10
3	Getting Started.....	11
3.1	Preparing for Use.....	11
3.2	Instrument Tour.....	15
4	Operating Basics.....	20
4.1	Control Panel.....	20
4.2	Display.....	23
4.3	Operating Concept.....	24
4.4	Integrated Help.....	25
4.5	Signal Display.....	25
4.6	General Instrument Settings.....	29
4.7	Self-Alignment.....	30
4.8	Firmware Update.....	31
4.9	Options.....	32
5	Waveform Setup.....	35
5.1	Vertical Setup.....	35
5.2	Horizontal Setup.....	40
5.3	Acquisition Setup.....	41
6	Trigger.....	48
6.1	Setting Up the Trigger.....	48
6.2	General Trigger Settings.....	49
6.3	Edge Trigger.....	50
6.4	Pulse Trigger.....	52

6.5	Logic Trigger.....	53
6.6	Video Trigger.....	56
6.7	Trigger Out Pulses.....	57
6.8	External Trigger Input.....	57
7	Analysis.....	59
7.1	Zoom Function.....	59
7.2	Marker Function.....	61
7.3	XY-Display.....	63
7.4	Mathematics.....	64
7.5	Frequency Analysis (FFT).....	72
7.6	Pass/Fail Test Based on Masks.....	76
7.7	Component Test.....	78
7.8	Digital Voltmeter.....	82
8	Measurements.....	84
8.1	Quick View.....	84
8.2	Cursor Measurements.....	85
8.3	Automatic Measurements.....	88
9	Documenting Results.....	95
9.1	Saving and Loading Instrument Settings.....	95
9.2	Reference Waveforms.....	98
9.3	Waveforms (Traces).....	100
9.4	Screenshots.....	104
9.5	Quick Access with FILE/PRINT Key.....	106
10	Mixed Signal Operation (Option R&S RTCB1).....	108
10.1	Using Logic Channels.....	108
10.2	Logic Trigger for Digital Input.....	111
10.3	Cursor Measurements for Logic Channels.....	111
10.4	Automatic Measurements for Logic Channels.....	112
10.5	Using Logic Channels in Buses.....	112
11	Signal Generation (Option R&S RTCB6).....	115
11.1	Function Generator.....	115
11.2	Pattern Generator.....	116

12	Serial Bus Analysis.....	121
12.1	Bus Configuration.....	121
12.2	Bus Table: Decode Results.....	123
12.3	I ² C Bus (Option R&S RTCK1).....	125
12.4	SPI / SSPI BUS (Option R&S RTCK1).....	131
12.5	UART/RS-232 BUS (Option R&S RTCK2).....	136
12.6	CAN Bus (Option R&S RTCK3).....	142
12.7	LIN Bus (Option R&S RTCK3).....	148
13	Network Connections and Remote Operation.....	155
13.1	LAN Connection.....	155
13.2	Remote Access Using a Web Browser.....	158
13.3	USB Connection.....	163
13.4	Switching to Remote Control.....	167
14	Remote Commands Reference.....	168
14.1	Conventions Used in Remote Command Description.....	168
14.2	Common Commands.....	168
14.3	Acquisition and Setup.....	172
14.4	Trigger.....	198
14.5	Display.....	207
14.6	Measurements.....	215
14.7	Quickmath and Reference Waveforms.....	228
14.8	FFT.....	236
14.9	Masks.....	240
14.10	Function Generator.....	247
14.11	Pattern Generator.....	248
14.12	Digital Voltmeter.....	254
14.13	Counter.....	257
14.14	Component Tester.....	257
14.15	External input.....	258
14.16	Protocol Analysis.....	262
14.17	Data and File Management.....	315
14.18	General Instrument Setup.....	324
14.19	Status Reporting.....	327

15	Contacting Customer Support.....	333
	Annex.....	334
A	SCPI Command Structure.....	334
A.1	Syntax for Common Commands.....	334
A.2	Syntax for Instrument-Specific Commands.....	335
A.3	SCPI Parameters.....	336
A.4	Overview of Syntax Elements.....	339
A.5	Structure of a Command Line.....	340
A.6	Responses to Queries.....	341
B	Command Sequence and Synchronization.....	343
B.1	Preventing Overlapping Execution.....	343
C	Status Reporting System.....	346
C.1	Structure of a SCPI Status Register.....	346
C.2	Hierarchy of status registers.....	347
C.3	Contents of the Status Registers.....	349
C.4	Application of the Status Reporting System.....	354
C.5	Reset Values of the Status Reporting System.....	356
D	General Programming Recommendations.....	357
	List of commands.....	358

1 Safety Information

The R&S RTC1000 digital oscilloscope is designed for measurements on circuits that are only indirectly connected to the mains or not connected at all. It is not rated for any measurement category.

The instrument is rated for pollution degree 2 - for indoor, dry location use where only non-conductive pollution occurs. Temporary conductivity caused by condensation is possible.

The instrument is intended for use in industrial areas. When used in residential areas, radio disturbances caused by the instrument can exceed given limits. Additional shielding can be required.

The instrument must be controlled by personnel familiar with the potential risks of measuring electrical quantities. Observe applicable local or national safety regulations and rules for the prevention of accidents.

Safety information is part of the product documentation. It warns you about the potential dangers and gives instructions how to prevent personal injury or damage caused by dangerous situations. Safety information is provided as follows:

- The "Basic Safety Instructions" in different languages are delivered as a printed brochure with the instrument.
- Throughout the documentation, safety instructions are provided when you need to take care during setup or operation.

1.1 Safety Instructions

To prevent electric shock, personal injury or fire, follow these rules:

- Do not open the instrument casing.
- Do not use the instrument if you detect or suspect any damage of the instrument or accessories.
- Do not operate the instrument in wet, damp or explosive atmospheres.
- Make sure that the instrument is properly grounded.
- Do not use the instrument to ascertain volt-free state.
- Do not exceed the voltage limits given in [Chapter 3.2.1.1, "Input Connectors"](#), on page 16.

An unsuitable operating site or test setup can damage the instrument and connected devices. Ensure the following operating conditions before you switch on the instrument:

- Read and observe the "Basic Safety Instructions" brochure and the safety instructions in the manuals.
- Observe the operating conditions specified in the data sheet. Note that the general safety instructions also contain information on operating conditions.
- Position the instrument as described in the following sections.

Make sure that all fan openings are unobstructed and the airflow perforations are unimpeded. The minimum distance from the wall is 10 cm.

- Signal levels at the input connectors are all within the specified ranges.
- Signal outputs are correctly connected and are not overloaded.

1.2 Korea Certification Class A



이 기기는 업무용(A급) 전자파 적합기기로서 판매자 또는 사용자는 이 점을 주의하시기 바라며, 가정외의 지역에서 사용하는 것을 목적으로 합니다.

2 Documentation Overview

This section provides an overview of the R&S RTC1000 user documentation.

2.1 Manuals and Instrument Help

You find the manuals on the product page at:

www.rohde-schwarz.com/manual/rtc1000

Getting started manual

Introduces the R&S RTC1000 and describes how to set up the product. A printed English version is included in the delivery.

User manual

Contains the description of all instrument modes and functions. It also provides an introduction to remote control, a complete description of the remote control commands with programming examples, and information on maintenance and instrument interfaces. Includes the contents of the getting started manual.

The *online version* of the user manual provides the complete contents for immediate display on the internet.

Instrument help

The help offers quick, context-sensitive access to the functional description directly on the instrument.

Basic safety instructions

Contains safety instructions, operating conditions and further important information. The printed document is delivered with the instrument.

Instrument security procedures manual

Deals with security issues when working with the R&S RTC1000 in secure areas.

Service manual

Describes the performance test for checking the rated specifications, module replacement and repair, firmware update, troubleshooting and fault elimination, and contains mechanical drawings and spare part lists. The service manual is available for registered users on the global Rohde & Schwarz information system (GLORIS, <https://gloris.rohde-schwarz.com>).

2.2 Data Sheet and Brochure

The data sheet contains the technical specifications of the R&S RTC1000. It also lists the options with their order numbers and optional accessories. The brochure provides an overview of the instrument and deals with the specific characteristics.

See www.rohde-schwarz.com/brochure-datasheet/rtc1000

2.3 Calibration Certificate

The document is available on <https://gloris.rohde-schwarz.com/calcert>. You need the device ID of your instrument, which you can find on a label on the rear panel.

2.4 Release Notes, Open Source Acknowledgment

The release notes list new features, improvements and known issues of the current firmware version, and describe the firmware installation. The open source acknowledgment document provides verbatim license texts of the used open source software. It can also be read directly on the instrument.

See www.rohde-schwarz.com/firmware/rtc1000.

3 Getting Started

3.1 Preparing for Use

3.1.1 Unpacking and Checking the Instrument

1. Inspect the package for damage.

If the packaging material shows any signs of stress, notify the carrier who delivered the instrument.

2. Carefully unpack the instrument and the accessories.
3. Check the equipment for completeness. See section "[Delivery contents](#)" on page 11.

4. Check the equipment for damage.

If there is damage, or anything is missing, immediately contact the carrier as well as your distributor. Make sure not to discard the box and packing material.



Packing material

Retain the original packing material. If the instrument needs to be transported or shipped later, you can use the material to protect the control elements and connectors.

Delivery contents

The delivery package contains the following items:

- R&S RTC1000 digital oscilloscope
- R&S RT-ZP03 probe probes (2x)
- Country-specific power cable
- Printed "Getting Started" manual
- Printed "Basic Safety Instructions" brochure

3.1.2 Positioning the Instrument

The instrument is designed for use under laboratory conditions. It can be used in standalone operation on a bench top or can be installed in a rack.

For standalone operation, place the instrument on a horizontal bench with even, flat surface. The instrument can be used in horizontal position, or with the support feet on the bottom extended.

The instrument can be installed in a 19" rack mount using a rack mount kit. The order number of the rack mount kit is given in the data sheet. The installation instructions are part of the rack mount kit.

⚠ CAUTION

Risk of injury if feet are folded out

The feet can fold in if they are not folded out completely or if the instrument is shifted. This can cause damage or injury.

- Fold the feet completely in or out to ensure stability of the instrument. Never shift the instrument when the feet are folded out.
- When the feet are folded out, do not work under the instrument or place anything underneath.
- The feet can break if they are overloaded. The overall load on the folded-out feet must not exceed 200 N.

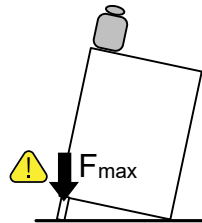

NOTICE

Risk of instrument damage due to overheating

An insufficient airflow can cause the R&S RTC1000 to overheat, which can impair the measurement results, disturb the operation, and even cause damage.

- Ensure that all fan openings are unobstructed and that the airflow perforations are unimpeded. The minimum distance to a wall is 10 cm.
- When placing several instruments side by side, keep a minimum distance of 20 cm between the instruments. Ensure that the instruments do not draw in the preheated air from their neighbors.
- When mounting the instrument in a rack, observe the instructions of the rack manufacturer to ensure sufficient airflow and avoid overheating.

3.1.3 Starting the Instrument

3.1.3.1 Powering On

The R&S RTC1000 can be used with different AC power voltages and adapts itself automatically to it.

The nominal ranges are:

- 100 V to 240 V AC at 50 Hz to 60 Hz, or 100 V to 120 V at 400 Hz
- max. 25 W

CAUTION

Risk of injury

Connect the instrument only to an outlet that has a ground contact.

Do not use an isolating transformer to connect the instrument to the AC power supply.

1. Connect the power cable to the AC power connector on the rear panel of the R&S RTC1000.

2. Connect the power cable to the socket outlet.

3. Switch the main power switch at the rear of the instrument to position I.

The [ON/OFF] key lights up when the instrument is in standby mode. The key is located next to the upper right corner of the screen.

You can leave the main power switch on to preserve your last instrument settings. To disconnect from power supply, power off the instrument.

3.1.3.2 Starting Up and Shutting Down

To start up the instrument

1. Make sure that the R&S RTC1000 is connected to the AC power supply and the main power switch on the rear panel is in position I.

2. Press the [ON/OFF] key. The key is located next to the upper right corner of the screen.

The instrument performs a system check and starts the firmware. If the previous session was terminated regularly, the oscilloscope uses the last settings.

Table 3-1: Colors of the [ON/OFF] key

Unlit	Instrument is on: firmware is working
Red	Standby: instrument is off, main power switch is on



Warm-up and prepare the instrument

Make sure that the instrument has been running and warming up before you start the self-alignment and the measurements. The minimum warm-up time is about 20 min.

To shut down the instrument to standby state

- ▶ Press the [ON/OFF] key.

All current settings are saved, and the software shuts down. Now it is safe to power off the instrument.

3.1.3.3 Powering Off

Powering off is required only if the instrument must be disconnected from all power supplies.

1. If the instrument is running, press the [ON/OFF] key on the front panel to shut down the instrument.
2. Switch the main power switch at the rear of the instrument to position 0.
3. Disconnect the AC power cable from the AC power supply.

NOTICE

Risk of losing data

If you switch off the running instrument using the rear panel switch or by disconnecting the power cord, the instrument loses its current settings. Furthermore, program data can be lost.

Press the ON/OFF key first to shut down the application properly.

3.1.3.4 EMI Suppression

Electromagnetic interference (EMI) may affect the measurement results.

To suppress generated electromagnetic interference (EMI):

- Use suitable shielded cables of high quality. For example, use double-shielded RF and LAN cables.
- Always terminate open cable ends.
- Note the EMC classification in the data sheet.

3.1.4 Replacing the Fuse

The instrument is protected by a fuse. You can find it on the rear panel between the main power switch and AC power supply.

Type of fuse: Size 5x20 mm, 250V~, T2.5H (slow-blow), IEC60127-2/5

⚠ WARNING**Risk of electric shock**

The fuse is part of the main power supply. Therefore, handling the fuse while power is on can lead to electric shock. Before opening the fuse holder, make sure that the instrument is switched off and disconnected from all power supplies.

Always use fuses supplied by Rohde & Schwarz as spare parts, or fuses of the same type and rating.

1. Pull the fuse holder out of its slot on the rear panel.
2. Exchange the fuse.
3. Insert the fuse holder carefully back in its slot until it latches.

3.2 Instrument Tour

3.2.1 Front Panel

Figure 3-1 shows the front panel of the R&S RTC1000. The function keys are grouped in functional blocks to the right of the display.

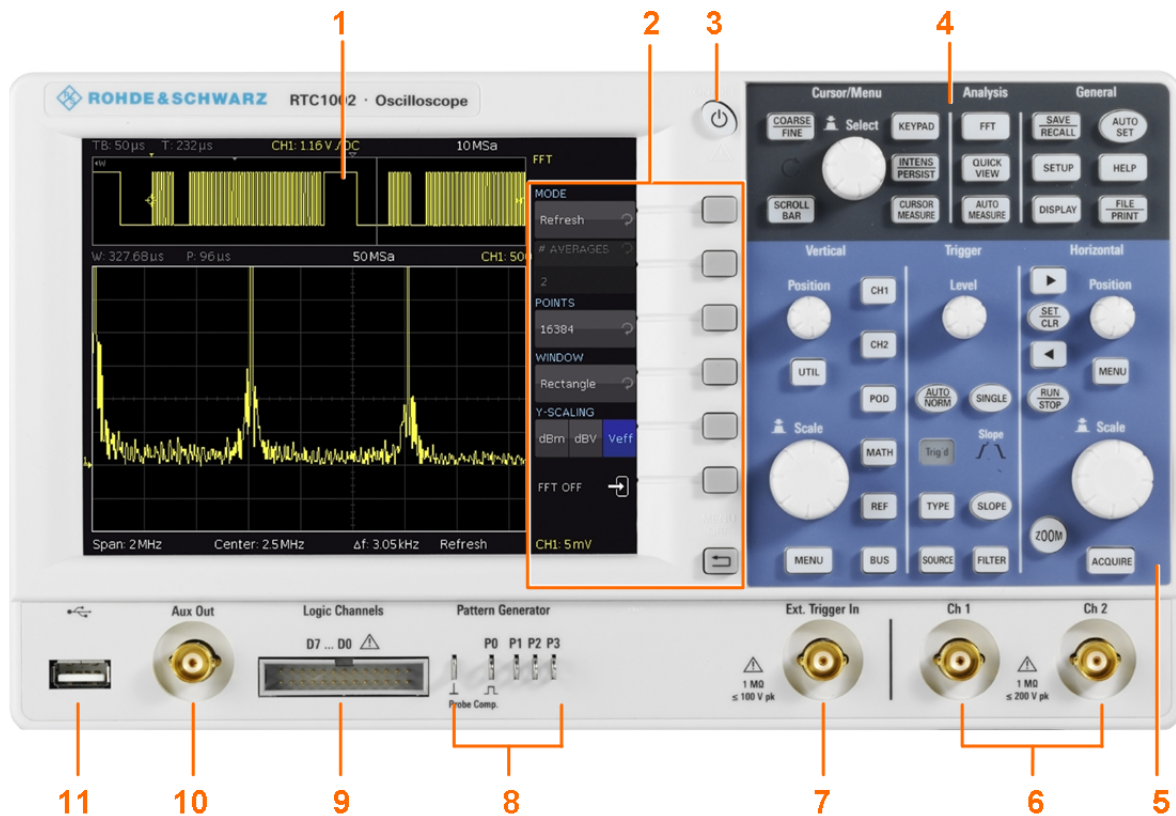

Figure 3-1: Front view of the R&S RTC1000

- 1 = Display
- 2 = Softkeys and menu
- 3 = [ON/OFF] key
- 4 = Cursor/Menu, Analyze and General sections
- 5 = Vertical, Trigger and Horizontal sections
- 6 = BNC connectors of the analog channel inputs
- 7 = BNC connector of the external trigger input
- 8 = Pattern generator output (option R&S RTCB6) and probe adjustment output
- 9 = Connector for the logic probe (option R&S RTCB1)
- 10 = Multi-purpose BNC connector [Aux Out]
- 11 = USB connector

3.2.1.1 Input Connectors



BNC inputs (6, 7)

The R&S RTC1000 has two channel inputs (6) to connect the input signals. The external trigger input (7) is used to control the measurement by an external signal. The trigger level can be set from -5 V to 5 V.

The input impedance of all BNC inputs is 1 M Ω .

WARNING

Risk of electrical shock - maximum input voltages

The maximum input voltage on *channel inputs* must not exceed 200 V (peak) and 150 V (RMS).

For the *external trigger input*, the maximum input voltage is 100 V (peak) and 70 V (RMS).

Transient overvoltages must not exceed 200 V (peak).

Voltages higher than 30 V (RMS) or 42 V (peak) or 60 V DC are regarded as hazardous contact voltages. When working with hazardous contact voltages, use appropriate protective measures to preclude direct contact with the measurement setup:

- Use only insulated voltage probes, test leads and adapters.
- Do not touch voltages higher than 30 V (RMS) or 42 V (peak) or 60 V DC.

CAUTION

Risk of injury and instrument damage

The instrument is not rated for any measurement category. When measuring in circuits with transient overvoltages of category II, III or IV circuits, make sure that no such overvoltages reach the R&S RTC1000 input. Therefore, use only probes that comply with DIN EN 61010-031. When measuring in category II, III or IV circuits, always insert a probe that appropriately reduces the voltage so that no transient overvoltages higher than 200 V (peak) are applied to the instrument. For detailed information, refer to the documentation and safety information of the probe manufacturer.

Explanation: According to section AA.2.4 of EN 61010-2-030, measuring circuits without any measurement category are intended for measurements on circuits which are not directly connected to the mains.

Logic probe (9)

The connector for logic channels can be used if the Mixed Signal Option R&S RTCB1 is installed. The option provides a logical probe with 8 digital channels (D0 to D7).

The maximum input voltage is 40 V (peak) at 100 k Ω input impedance. The maximum input frequency for a signal with the minimum input voltage swing and medium hysteresis of 800 mV (V_{pp}) is 300 MHz.

NOTICE**Risk of instrument damage**



Use the connector for the active logic probe exclusively for the logic probe R&S RT-ZL03, which is delivered with option R&S RTCB1. Connecting other probe types can demolish the input.

3.2.1.2 Other Connectors on the Front Panel**[Pattern Generator] (8)**

Connectors for the pattern generator P0, P1, P2, P3.

[Probe Comp.] (8)

Probe compensation terminal to support adjustment of passive probes to the oscilloscope channel.

-  Square wave signal for probe compensation.
-  Ground connector for probes.

[Aux Out] (10)

Multi-purpose BNC output that can function as pass/fail and trigger output, output for component testing, and as function generator output (with option R&S RTCB6).

[USB] type A (11)

USB 2.0 type A interface to connect a USB flash drive for storing and reloading instrument settings and measurement data, and to update the firmware.

3.2.2 Rear Panel

Figure 3-2 shows the rear panel of the R&S RTC1000 with its connectors.

On the back panel of the instrument, you find Ethernet and USB interfaces. Optional interfaces are not available.

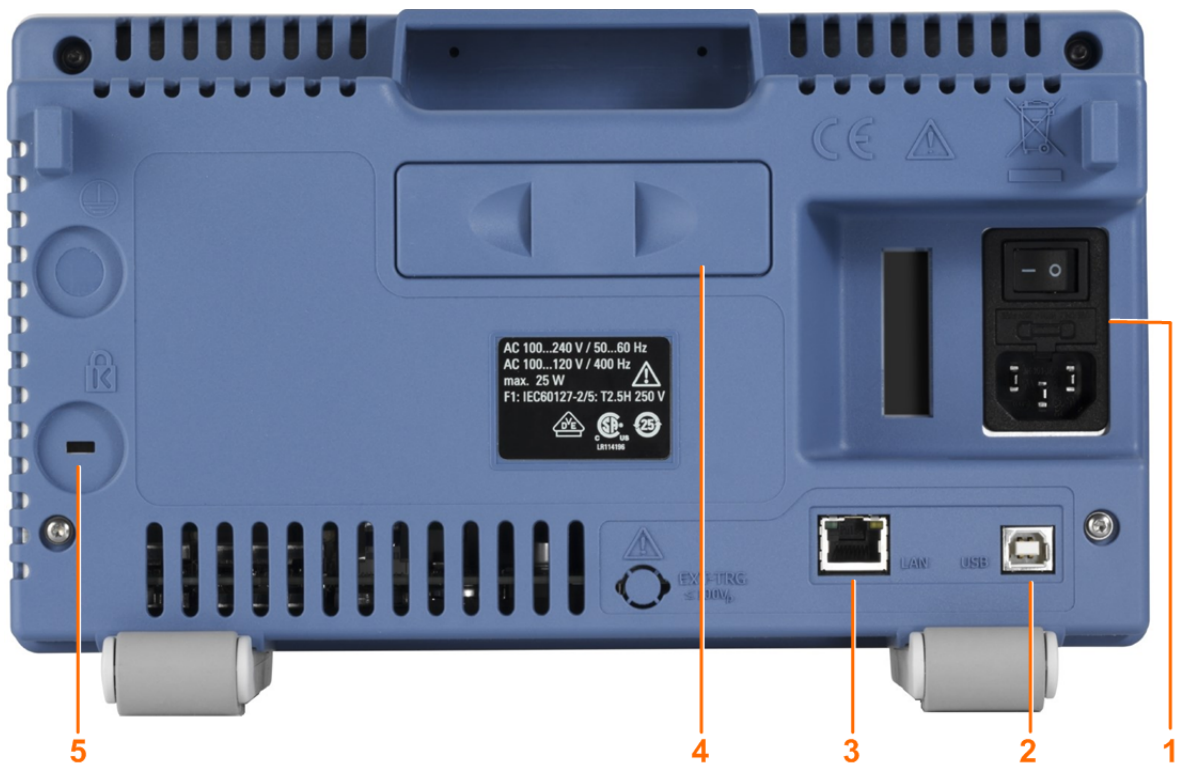

Figure 3-2: Rear panel view of R&S RTC1000

- 1 = AC power supply connector and main power switch
- 2 = USB connector, type B
- 3 = LAN connector
- 4 = not used
- 5 = Kensington lock slot to secure the instrument against theft

AC supply: mains connector and main power switch (1)

The instrument supports a wide range power supply. It automatically adjusts to the correct range for the applied voltage. There is no line voltage selector.

The AC main power switch disconnects the instrument from the AC power line.

[USB] type B (2)

USB 2.0 interface of type B (device USB) to connect a printer, or for remote control of the instrument.

Note: Electromagnetic interference (EMI) can affect the measurement results. To avoid any impact, use only USB connecting cables with a maximum length of 1 m.

[LAN] (3)

8-pin connector RJ-45 used to connect the instrument to a Local Area Network (LAN). It supports up to 100 Mbit/s.

4 Operating Basics

4.1 Control Panel

The controls on the front panel allow access to all basic functions. Advanced settings are easily accessible using the menu structure and gray softkeys. The [ON/OFF] button is clearly set apart by its design. The most important controls have colored LEDs, indicating the current setting.

4.1.1 Cursor/Menu Section



Universal rotary knob	The action of the universal knob depends on the selection in the menu: <ul style="list-style-type: none"> • Set a numeric value • Select a value in a list • Navigate through the menus • Select a highlighted value by pressing the knob, for example, in the keypad.
[COARSE/FINE]	Toggles between coarse and fine resolution of the universal rotary knob. The key lights up if fine resolution is active.
[SCROLLBAR]	Activates or deactivates the virtual screen.
KEYPAD	Opens the on-screen keypad. The key is illuminated if the keypad can be used.
INTENS/PERSIST	The first keypress sets the rotary knob to adjust the intensity of the waveforms (key is illuminated). The second keypress opens the menu to adjust all intensities and the persistence.
[CURSOR MEASURE]	Activates the cursors and opens the menu to set up cursor measurements.

4.1.2 Analysis Section



[FFT]	Starts a Fast Fourier Transformation and switches to frequency domain.
[QUICK VIEW]	Starts the quick measurements and shows the typical characteristics of the signal.
[AUTO MEASURE]	Opens a menu to set up automatic measurements. Up to 6 measurements can be performed at the same time.

4.1.3 General Section



[SAVE/RECALL]	Opens a menu to load and save instrument settings, reference signals, waveforms, screenshots of the display, and formularies. In the menu, you can also assign the function of the [FILE/PRINT] key.
[SETUP]	Opens the menu of general instrument settings, such as language, interfaces, date, time, firmware update, options, printer, and more.
[DISPLAY]	Opens a menu to activate the virtual screen, and to adjust the display settings.
[AUTOSET]	Press shortly to perform automatic setup. The instrument analyzes the active signals, and adjusts the horizontal, vertical, and trigger settings to display stable waveforms. Press and hold the key until you hear a beep. The most important settings of the scope are reset to their defaults.
[HELP]	Opens a window with the integrated help.
[FILE/PRINT]	Depending on the assigned function, [FILE/PRINT] can save instrument settings, signals, screenshots, or start a printout.

4.1.4 Vertical Section

The Vertical section features all controls for analog channels.



[Position] knob	Sets the vertical position of the selected waveform. To switch to fine tuning of the value, press the knob.
[Scale] knob	Sets the vertical scale (vertical gain) of the selected waveform. The scale value is shown below the grid.
[CH1], [CH2]	Activate the channel if the channel is off. Selects the channel if the channel is on and the other channel is selected. Switches off the channel if it is selected. If a channel is selected, its key is illuminated. If a channel is on but not selected, you see the signal on the display, and its key does not light up.
[POD]	Activates the logic channels if optional logic probe R&S RT-ZL03 is connected. Requires option R&S RTCB1.
[REF]	Opens the menu to create, save and load reference waveforms.
[MATH]	Opens a menu to create, save and load calculated waveforms.
[BUS]	Activates the serial and parallel bus analysis. Requires at least one of the options R&S RTCB1, R&S RTCK1, R&S RTCK2, or R&S RTCK3.

[MENU]	Opens the advanced menu for the selected waveform, bus or pod.
[UTIL]	Opens a menu with more applications: digital voltmeter, function and pattern generator (requires option R&S RTCB6), component tester, and trigger counter.

4.1.5 Trigger Section

The Trigger section provides all controls to adjust the trigger.

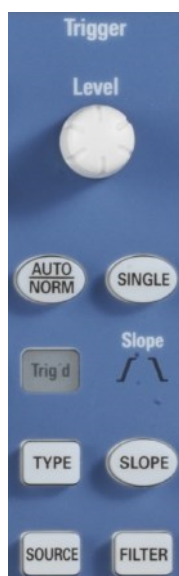

[LEVEL] knob	Sets the trigger level.
[AUTO/NORM]	Toggles between auto and normal trigger mode.
Trigg'd	The LED lights up if the instrument found a trigger event.
[TYPE]	Opens a menu to select the trigger type.
[SOURCE]	Opens a menu to select the trigger source.
[SINGLE]	Starts a single acquisition.
[SLOPE]	Selects the slope for the edge trigger, or the polarity for the pulse trigger. The selection is indicated by the Slope LEDs.
[FILTER]	Opens a menu to set up the trigger condition for the selected trigger type.

4.1.6 Horizontal Section

In the Horizontal section, you set the horizontal and acquisition settings, zoom, and markers.



[Left Arrow], [Right Arrow] / [SET/CLR]	Set and deletes markers, and navigate markers. If no markers are set, the arrow keys move the trigger position by 5 division to the left or right. [SET/CLR] resets the value to the time reference point.
[RUN/STOP]	Starts and stops continuous data acquisition. The key lights up in red if acquisition is stopped.
[ZOOM]	Activates and deactivates the zoom display.
[Position] knob	Sets the trigger position (horizontal position). The maximum value depends on the time base. If a zoom window is active, the knob sets the zoom position. If markers are set, the knob sets the marker position.
[MENU]	Opens a menu to set the trigger position.
[Time base] knob	Sets the horizontal scale (time base) for all waveforms. The scale value is shown above the grid on the left. If a zoom window is active, the knob sets the zoom size.
[ACQUIRE]	Opens a menu to select the acquisition mode and record mode.

4.2 Display

The R&S RTC1000 is equipped with a TFT color monitor with LED backlight and VGA resolution (640x480 pixels). If the soft menu is closed, the display has 12 scale divisions on the time axis. If the menu is shown, 10 divisions are shown. In vertical direction, the display has 8 divisions.

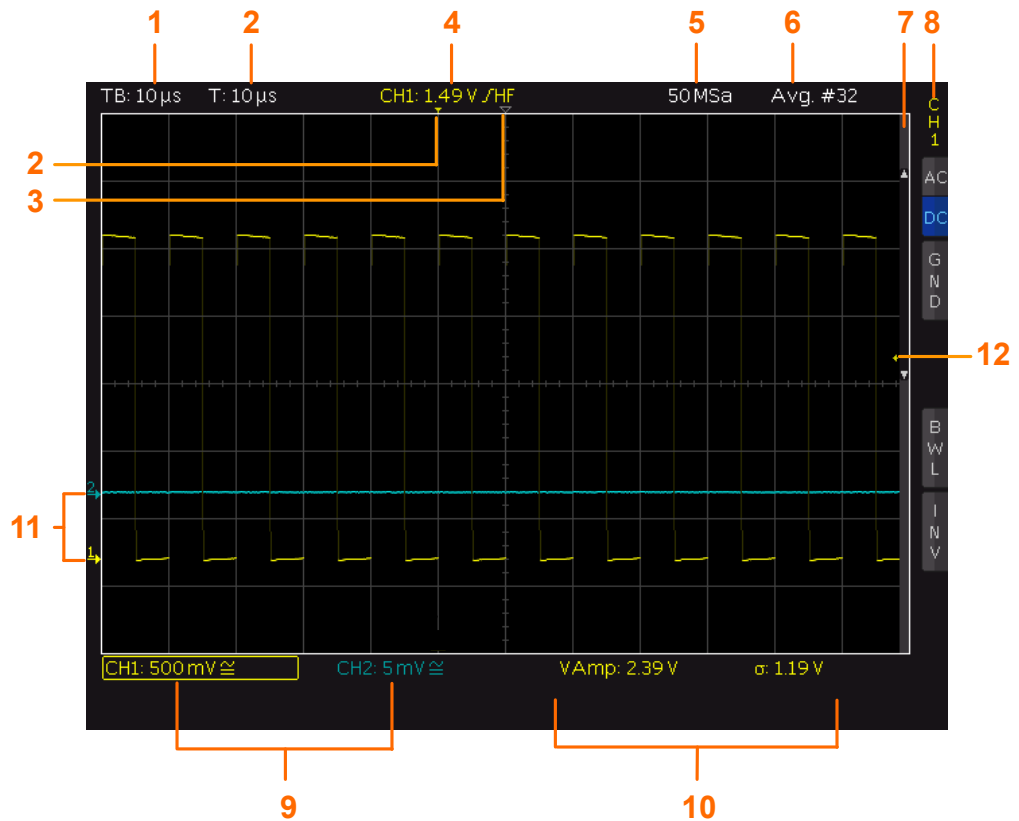

- 1 = Horizontal scale (time base), in s/div
- 2 = Trigger position
- 3 = Time reference, zero point of the time axis
- 4 = Trigger settings: source, level, type, and filter conditions
- 5 = Sample rate
- 6 = Acquisition mode
- 7 = Vertical scrollbar, visible if virtual screen with 20 vertical divisions is on
- 8 = Short menu with most important settings of the selected channel
- 9 = Vertical settings of active waveforms: vertical scale in V/div, coupling, and bandwidth limit (if set). Channel 1 is selected.
- 10 = Measurement results
- 11 = Reference potentials of the channels
- 12 = Trigger level

4.3 Operating Concept

The general operating concept is based on a few key principals, recurring with various settings and functions:

- Keys work in one of these ways:
 - The key opens a soft menu when pressed once. It closes the soft menu when pressed a second time.
 - The key activates a specific function. Pressing this key a second time deactivates the function.

- Depending on the requirements, the [Universal] knob in the Cursor/Menu section either selects a value, or navigates through menus. The COARSE/FINE key toggles between fine and coarse resolution of the [Universal] knob.
- The "MENU OFF" key below the softkeys closes the current menu, or switches to the next higher level.
- The effect of channel keys depends on the state of the selected waveform:
 - Activate the channel if the channel is off.
 - Selects the channel if the channel is on and the other channel is selected.
 - Switches off the channel if it is selected.
 - If a channel is selected, its key is illuminated. If a channel is on but not selected, you see the signal on the display, and its key does not light up.

The menus include some navigation elements and usage principles.

- Press the softkey to select or toggle a value. The selected value is marked in blue.
- Some functions must be activated and require value selection. Pressing the softkey toggles between "OFF" and the last set value. Use the [Universal] knob to change the value.
- A round arrow in the softkey indicates that the value is set with the [Universal] knob.
- A small triangle on the bottom right of a softkey indicates an additional menu level.
- If additional menu pages are available, the lowest softkey navigates through the menu pages. The current page is shown in the soft menu.

4.4 Integrated Help

The integrated help shows explanatory text about the selected function. The text in the help window is dynamically updated when you select another function.

1. To activate the integrated help, press the [HELP] key in the General section.
The help window opens, and the [HELP] key lights up.
2. If you no longer need help, press [HELP] again.

4.5 Signal Display

This chapter describes the display of signals and the available display modes.

4.5.1 Display Settings

- ▶ To adjust the display, press the [DISPLAY] key.

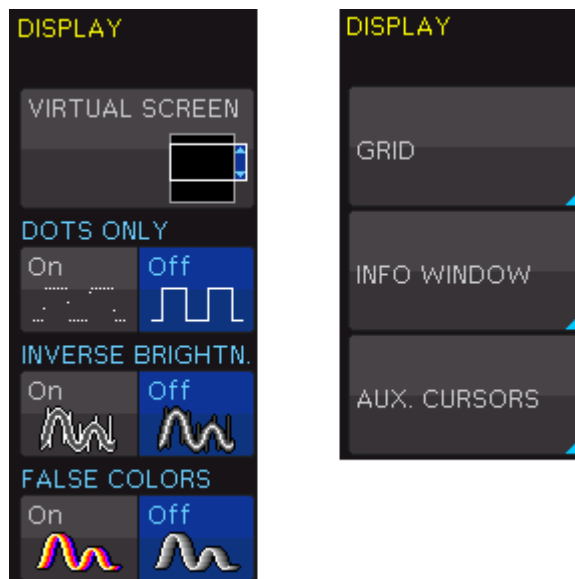

Figure 4-1: Display menu, page 1/2 (left) and page 2/2 (right)

VIRTUAL SCREEN

See [Chapter 4.5.2, "Virtual Screen"](#), on page 27.

DOTS ONLY

If enabled, only the acquired data points are shown. The data points are not connected by lines. If disabled, interpolated data points are also shown, and the waveform is a continuous line.

INVERSE BRIGHTN.

Inverts the brightness of the displayed signals points. Normally, frequently captured dots are displayed more brightly than rare dots. If inverted, rare events are displayed with higher brightness. To capture rare events in a signal, this setting can be used in combination with persistence.

FALSE COLORS

Converts the brightness level of the displayed signal points to a color scale, ranging from blue, magenta, red and yellow to white. Due to the higher contrast, you can see signal details easily. This setting applies to all signals.

GRID

Sets the display of the grid: "LINES", "RETICLE", or "OFF".

INFO WINDOW

Info windows are small windows that appear on the screen depending on the current application. You can change the format of information windows:

"TRANSPARENCY"

Use the Universal knob to or the [KEYPAD] to change the value from 0% to 100%.

"POSITION"	If activated and the vertical position is changed, the value of the vertical position is shown at the zero line.
"ACQ.STA-TUS"	If activated, the information on the acquisition status is shown. In normal trigger mode, if the trigger condition is fulfilled, the information window shows a progress display for the post-trigger and pre-trigger. If the trigger condition is not met, the information window shows the time since the last trigger event ("Trig?"). In automatic trigger mode, no information is shown.

AUX. CURSORS

You can enable or disable the cursor and channel markers on the display. Select "DEFAULTS" to reset the settings.

4.5.2 Virtual Screen

Normally, the grid of the R&S RTC1000 has 8 vertical divisions. It has also a virtual range of 20 divisions. These virtual divisions can be used entirely by the optional digital channels D0 to D7, the mathematical channels and the reference signals. The analog channels can use up to ± 10 divisions from the center. This allows a simple and clear display of many waveforms.

[Figure 4-2](#) illustrates the functionality of the virtual screen. The scroll bar next to the grid indicates the position of the 8 visible divisions within the available 20 divisions.

1. Press the [DISPLAY] key in the General section.
2. Activate "VIRTUAL SCREEN".
A scrollbar is shown to the right of the grid.
3. To activate or deactivate the scrollbar, press the [SCROLL BAR] key.
The scrollbar is shown in blue if it is active.
4. If the scrollbar is active, use the Universal knob to move the display window within the 20 divisions of the virtual screen.

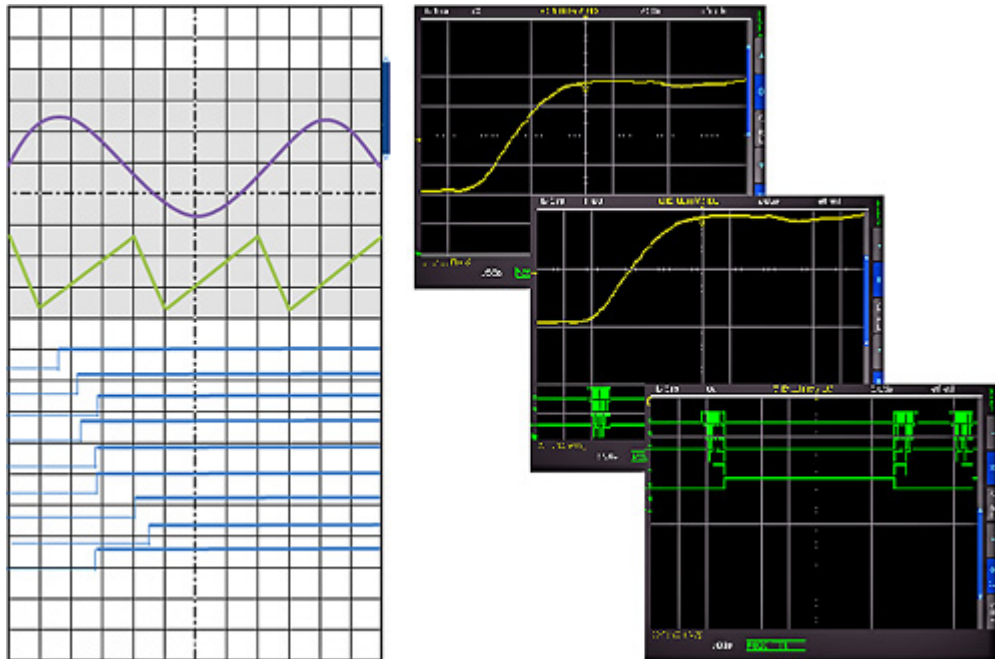

Figure 4-2: Drawing of the virtual screen area

4.5.3 Signal Intensity and Persistence

To change the intensity of the waveforms:

1. Press the [INTENS/PERSIST] key in the Cursor/Menu section until it lights up in white.
2. Turn the Universal knob to change the intensity of the signal display from 0% to 100%.

To access further intensity and persistence settings:

1. If the [INTENS/PERSIST] key is illuminated in white, press this key again.
2. Use the menu functions to adjust the settings.

The following settings are available:

TRACE, GRID, BACKLIGHT

Use the Universal knob to adjust the waveform intensities, grid intensity, and the back-lighting.

PERSISTENCE

Persistence defines how subsequent captured waveforms are shown simultaneously. Older waveforms are displayed in darker color (they fade), and newer waveforms are displayed in lighter color. Thus, signals points occurring more frequently are displayed in lighter color. The display is similar to that of an analog oscilloscope

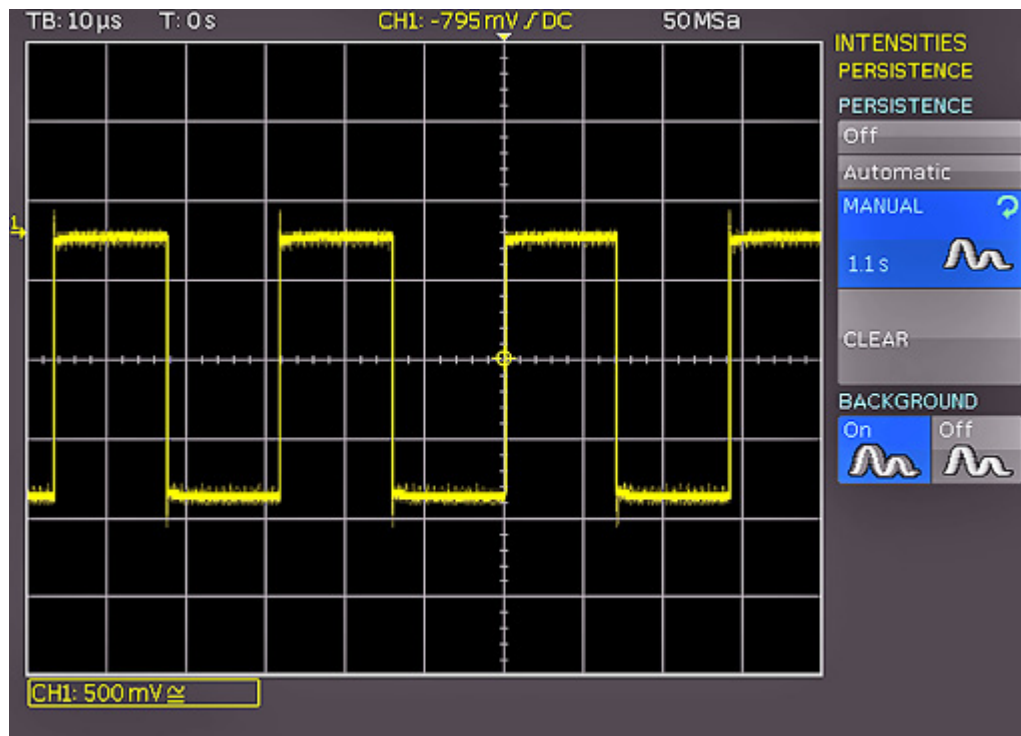

Figure 4-3: Persistence function

- "MANUAL" You can set a duration of 50 ms to infinite by using the [universal] knob or the [KEYPAD] key. If a finite duration is selected, new signals are written on top of one another. The most recent captures are displayed more brightly than older signals. For example, if 300 ms is selected, the display of the waveform becomes darker in 50 ms intervals and is erased after 300 ms.
- "AUTOMATIC" The instrument sets the optimal persistence time.
- "OFF" Persistence is deactivated.
- "BACKGROUND" When enabled, older waveforms do not disappear entirely after the set persistence time. Instead, waveforms are displayed in the background with low brightness. This display is useful for the analysis of peak values in signals, for example.

4.6 General Instrument Settings

The instrument settings are provided in the "SETUP" menu.

- ▶ Press the [SETUP] key in the General section.

"LANGUAGE"	Selects the language for user interface and help.
"SELF ALIGNMENT"	The instrument adjusts vertical accuracy, time base and several trigger settings and saves the identified correction data internally. See also: Chapter 4.7, "Self-Alignment" , on page 30.
"PROBE ADJUST"	Aligns the probe. A wizard explains all steps on the display.
"INTERFACE"	Configures the USB and Ethernet (LAN) interfaces. See also: Chapter 13, "Network Connections and Remote Operation" , on page 155.
"DEVICE INFORMATION"	Shows detailed information on hardware and software of the instrument.
"UPDATE"	Firmware update, see Chapter 4.8, "Firmware Update" , on page 31.
"OPTIONS"	Activation of options, see Chapter 4.9, "Options" , on page 32.
"DATE & TIME"	Sets the date and time.
"SOUND"	You can activate a control beep to get information on the instrument's activities, error beep, and trigger beep.
"DEVICE NAME"	You can define a name with up to 19 characters, which is listed when screenshots are printed.
"MENU OFF"	Selects whether you close the menus manually, or they are closed automatically after a specified time.
"DEVICE LOGO IN SCREENSHOT"	If activated, the R&S logo is printed in the upper right corner of screenshots and printouts.
"EDUCATION MODE"	Activates and deactivates the education mode. You can set a password to prevent unwanted deactivation. In education mode, the AUTOSET, QUICK VIEW and automatic measuring functions are disabled. This information is also shown in the device information window.
"PRINTER"	Configures the printer, see Chapter 9.4.2, "Printing Screenshots" , on page 105.

4.7 Self-Alignment

The R&S RTC1000 features an integrated self-alignment procedure to achieve the highest possible accuracy. During the standard self-alignment, the instrument adjusts vertical accuracy, offset, time base and several trigger settings and saves the identified correction data internally.



Make sure that the instrument has been running and warming up for at least 20 minutes before you start the self-alignment.

Remove all probes and connected lines from the inputs.

1. Press the [SETUP] key.

2. Press "SELF ALIGNMENT".
3. Press "START".

The procedure can take up to 16 minutes.

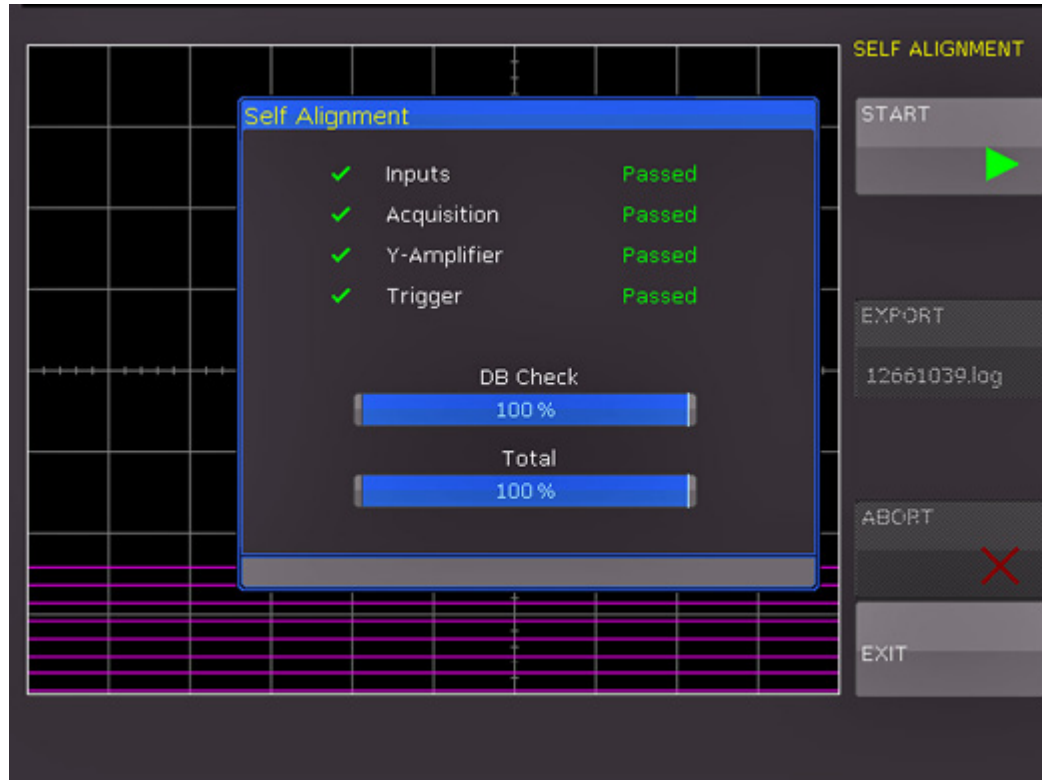

Figure 4-4: Self-alignment successful

If an error occurs during the self-alignment although it has been carried out as described, export the .log file in the "SELF ALIGNMENT" menu. Send the log file to our customer support center, see [Chapter 15, "Contacting Customer Support"](#), on page 333. You can also save the log file to a USB flash drive.

4.8 Firmware Update

Your instrument is delivered with the latest firmware version. Firmware updates are provided on the Internet at www.rohde-schwarz.com/firmware/rtc1000. Along with the firmware file, you find the Release Notes describing the improvements and modifications.

Make sure to update the firmware if a new version is available.

1. Download the firmware installation file `RTC1002.FWU` to a USB flash drive.
2. Connect the USB flash drive to the USB connector at the front of the instrument.

3. Press the [SETUP] key.
4. Go to menu page 2/3.
5. Select "UPDATE".
A window with information about the installed firmware and front controller firmware is shown.
6. Select "FIRMWARE".
The information on the new firmware is added in the window. If you have no newer firmware than the installed one, a message appears.
7. Wait until the firmware file is loaded.
8. To start the firmware update, select "EXECUTE".
Wait until the update has finished. The instrument restarts automatically.

4.9 Options

All options are activated by license keys. No additional installation or hardware change is required.

Consult your sales representative and provide the material number, serial number, and the device ID of your instrument to get a license key. You find this information on the bar code sticker at the rear panel, and in "SETUP" menu > "DEVICE INFORMATION".

The license key is provided in written form or in a file. Unregistered licenses must be registered in the R&S License Manager before they can be activated on the instrument.



Unregistered licenses

Unregistered licenses are not assigned to a particular instrument. The instrument accepts only registered licenses. If your license is delivered unregistered, use the online tool R&S License Manager to register the license for your instrument. The registration of a permanent license is irreversible, so ensure that you register it for the correct instrument. The address of the tool is <https://extranet.rohde-schwarz.com/service>.

1. If you received the option key in a file, save the file to a USB flash drive.
2. Connect the USB flash drive to the R&S RTC1000.
3. Press the [SETUP] key.
4. Go to menu page 2/3.
5. Select "Options".
A window with information on the active options is shown.

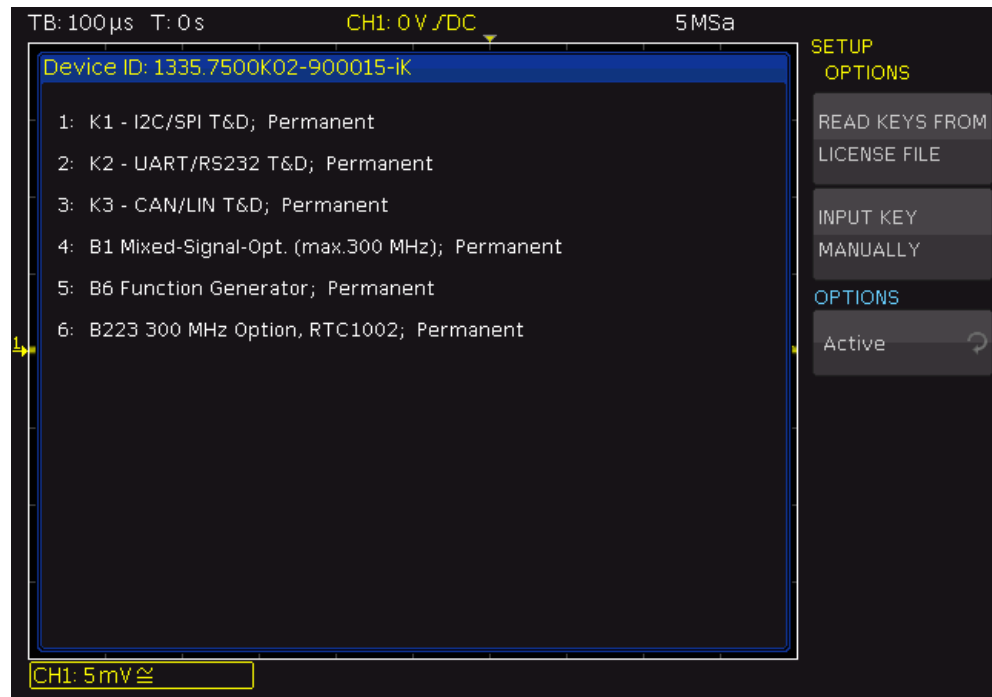

6. If you received a key in written form:
 - a) Select "INPUT KEY MANUALLY".
 - b) Enter the key.

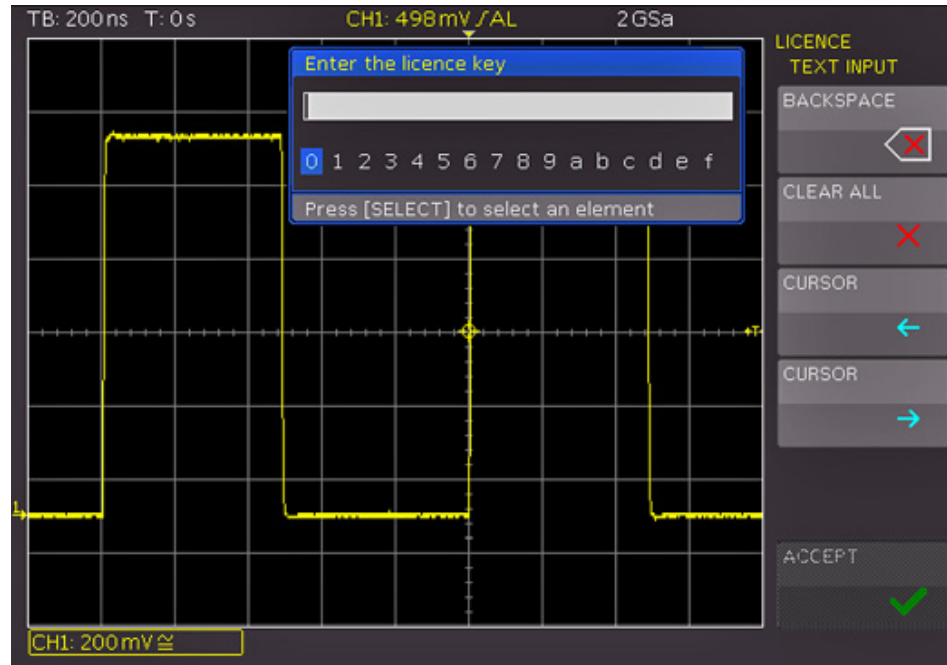

7. If you received a key in digital form as a file:
 - a) Select "READ KEYS FROM LICENSE FILE".
 - b) Select the "Front" storage and change directory if necessary.
 - c) Turn the [Universal] knob to select the license file.

- d) Select "LOAD".
- 8. If you want to activate several options, repeat step 6 or 7 for each option.
- 9. Restart the instrument.

5 Waveform Setup

5.1 Vertical Setup

The most important vertical settings are permanently available for adjustment:

- Channel keys to switch on or off and to select a channel
- Rotary knobs to adjust vertical scale and position
- Short menu to adjust coupling, ground, bandwidth filter and to invert the waveform.

Advanced settings are provided in the "Vertical" menu.

The channel labels show the current vertical settings of each channel.



Figure 5-1: Channel labels: Channel 1 is selected, is DC coupled and bandwidth limited. Channel 2 is AC couples and inverted.

Make sure to check and adjust the probe attenuation value in the channel menu.

- [Vertical Controls](#)..... 35
- [Vertical Settings in the Channel Menus](#)..... 35
- [Probe Compensation](#)..... 38

5.1.1 Vertical Controls

In the Vertical section of the front panel, you select the channel, set scale and position, and open the vertical menu. The key of the selected channel lights up.



Vertical scale (sensitivity) and vertical position (Y-position or offset) are the basic vertical settings. Each channel has its individual vertical values.

1. To select the desired channel, press its channel key.
2. To set the vertical scale of the selected channel, turn the [Scale] knob in the Vertical section. You can select the sensitivity in 1-2-5 steps of 1mV/div to 10V/div. Press the knob once to switch to a continuous value setting.
3. To set the vertical position of the selected channel, turn the [Position] knob in the Vertical section.

For a complete description of the Vertical section of the frontpanel, see [Chapter 4.1.4, "Vertical Section"](#), on page 21.

5.1.2 Vertical Settings in the Channel Menus

To open the vertical menu for a channel:

1. Select the channel using its [CH] key.
2. Press the [MENU] key in the Vertical section.

Page 1 of the menu shows the settings of the short menu, page 2 provides further settings.

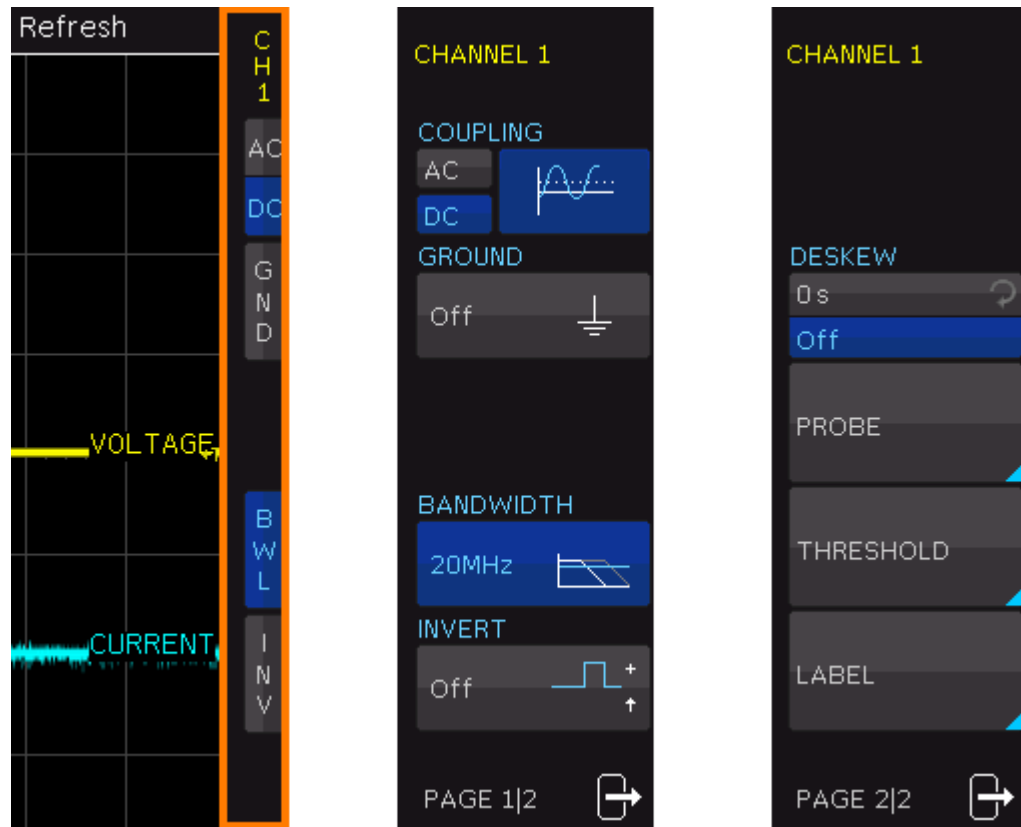

Figure 5-2: Vertical menus: short menu (left), page 1 and page 2 of the advanced menu

COUPLING

The analog channels have an input impedance of 1 M Ω . The input coupling influences the signal path between input connector and the following internal signal stage. The current coupling of each channel is shown in the channel labels below the grid.

- "AC" AC coupling blocks the DC component of the signal so that the waveform is centered on zero volts. AC coupling is useful if the DC component of a signal is of no interest.
- If AC coupling is set, the attenuation of passive probes has no effect, and voltage is applied to the instrument with factor 1:1. Observe the voltage limits, otherwise you can damage the instrument.
- "DC" With DC coupling, the input signal passes unchanged, all signal components are shown.

GROUND (GND)

Connects the input to a virtual ground. All channel data is set to 0 V. Ground connection is indicated with \perp in the waveform labels. The coupling is not affected by the ground setting.

BANDWIDTH (BWL)

Inserts an analog 20 MHz low-pass filter to the signal path. Higher frequencies are removed to reduce noise.

Limited bandwidth is indicated by "B_w" in the waveform label.

INVERT (INV)

Turns the inversion of the signal amplitude on or off. To invert means to reflect the voltage values of all signal components against the ground level. Inversion affects only the display of the signal but not the trigger.

For example: if the oscilloscope triggers on the rising edge, the trigger is not changed by inversion, but the actually rising edge is displayed as falling edge.

Inversion is indicated in the waveform labels by line above the channel name.

DESKEW

Each analog channel can be shifted in time by ± 32 ns. The deskew setting is used to compensate different signal delays when different cable lengths or probes are used.

To activate this offset, press the softkey. Turn the [Universal] knob to set the value, or use the [KEYPAD].

PROBE

The attenuation of the delivered probes R&S RT-ZP03 probe can be switched: 10:1 or 1:1. The instrument does not detect the probe attenuation automatically. Therefore, make sure to set up the correct attenuation factor manually.

If AC coupling is set, the attenuation of passive probes has no effect, and voltage is applied to the instrument with factor 1:1. Observe the voltage limits, otherwise you can damage the instrument.

You can select a predefined value "x1", "x10", "x100", "x1000". If predefined values do not fit, select "USER" and enter a value between x0.001 and x1000.

"UNIT" defines the measurement unit:

- V - for voltage measurements
- A - for current measurements if a current probe is connected, or current is measured using a shunt. The menu shows the most common factors "1V/A", "100mV/A", "10mV/A" and "1mV/A".

All measurements are always displayed with the correct unit and scale.

THRESHOLD menu

The "THRESHOLD" key on page 2/2 opens the threshold menu.

The threshold defines the level to detect a high or low signal state if analog channels are used as source for the serial bus analysis or logic trigger.

"THRESH-
OLD" Sets the threshold value.

- "HYSTERE-SIS" Sets a range around the threshold level to avoid the change of signal states due to noise. If the signal oscillates only inside the hysteresis range and crosses the threshold, no state transition occurs.
- "FIND LEVEL" The instrument analyzes the channel and sets the appropriate threshold.

LABEL

The "LABEL" key on page 2/2 opens the label menu to define a name label for the selected waveform. The label is shown and printed at the waveform on the right edge of the display. It moves with the waveform if vertical position is changed.

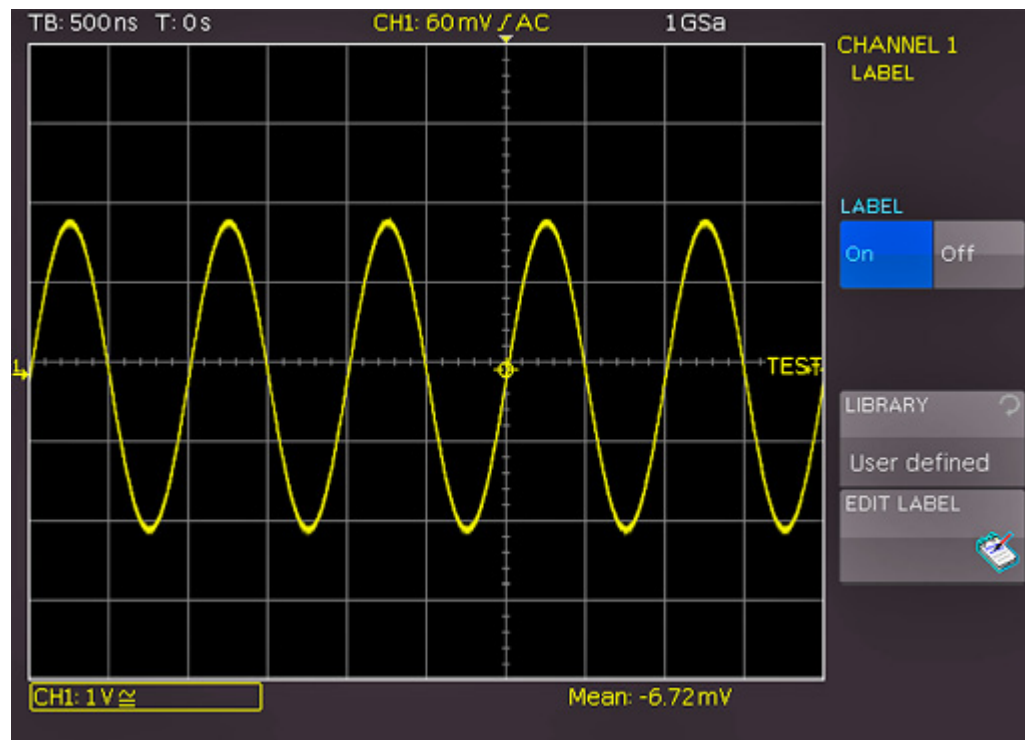

Figure 5-3: Label menu

- "LABEL" Activates or deactivates the label display.
- "LIBRARY" Selects a predefined label text. You can edit the text with "EDIT LABEL"
- "EDIT LABEL" Opens on-screen keypad to enter a label text. The maximum name length is 8 characters, and only ASCII characters provided on the on-screen keypad can be used.
If you previously have selected a text from the library, it is already written in the entry line, and you can modify it.

5.1.3 Probe Compensation

Compensation matches the probe cable capacitance to the oscilloscope input capacitance to assure good amplitude accuracy from DC to upper bandwidth limit frequen-

cies. A poorly compensated probe reduces the performance of the probe-oscilloscope system and introduces measurement errors resulting in distorted waveforms and inaccurate results.



Make sure to align passive probes before their first use, after an extended measurement break, or when switching instruments or channels.

Two connector pins for compensation are located at the front panel. The left pin is on ground level. The next pin supplies a square wave signal for the adjustment.

To perform probe compensation using the wizard

1. Press the [SETUP] key in the General section.
2. Press the "PROBE ADJUST" softkey.
3. Follow the instructions of the wizard. It guides you through the compensation process.

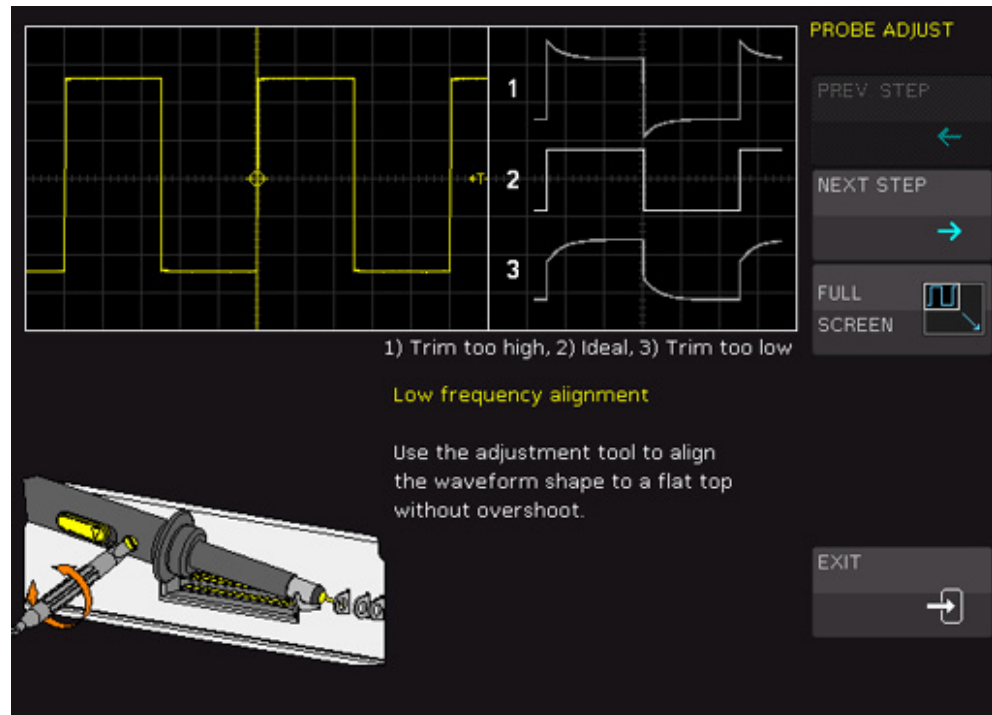

4. Use the compensation trimmer of the probe to get optimum square wave response. For details, refer to the documentation of your probe. The compensation is performed at 1 kHz (LF) and 1 MHz (HF).

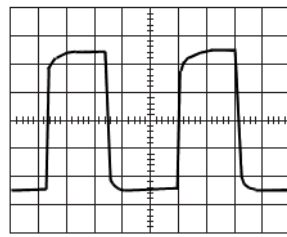

undercompensated

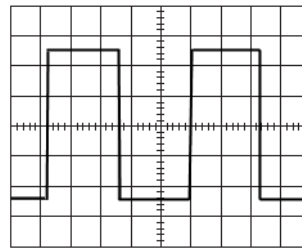

optimum

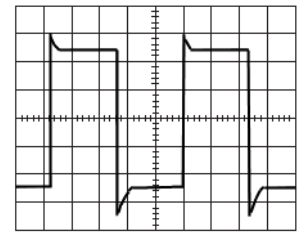

overcompensated

To perform probe compensation manually

1. Press the [UTIL] menu in the Vertical section.
2. Select the "PATTERN GEN." softkey.
3. Select "SQUARE WAVE" (see [Chapter 11.2.1, "Square Wave"](#), on page 116).
4. Use the compensation trimmer of the probe to get optimum square wave response. For details, refer to the documentation of your probe.

5.2 Horizontal Setup

Horizontal settings, also known as timebase settings, adjust the waveforms in horizontal direction.

Typically, the trigger is the determining point of the waveform record. In many scenarios, you want to analyze the waveform some time before or after the trigger. To adjust the horizontal acquisition window to the waveform section of interest, you can use the following parameters:

- The **trigger position (horizontal position)** defines the time distance of the trigger point to the reference point. Changing the trigger position, you can move the trigger point, even outside the screen.
- The **reference point** is the zero point of the diagram and the rescaling center of the time scale on the screen. If you modify the time scale, the reference point remains fixed on the screen, and the scale is stretched or compressed to both sides of the reference point.

In the HORIZONTAL section of the front panel, you can:

- Adjust the timebase, trigger position, and acquisition settings, see ["To adjust timebase and trigger position"](#) on page 41.
- Activate the zoom, see [Chapter 7.1, "Zoom Function"](#), on page 59.
- Set markers, see [Chapter 7.2, "Marker Function"](#), on page 61.



To adjust timebase and trigger position

1. To set the timebase (horizontal scale), turn the [Scale] knob in the Horizontal section.
The current timebase setting, e.g. "TB: 500 ns", is displayed in the upper left above the grid. The default setting shows the trigger in the center of the display, with 50% of the signal display before and 50% after this trigger position.
2. To set the trigger position, use one of these methods:
 - Turn the [Position] knob.
 - Use the arrow keys.
 - Press the [MENU] key.
In the submenu, you can:
 - Set an exact value: "NUMERIC INPUT"
 - Set the trigger position to minimum or maximum value: "MINIMUM" or "MAXIMUM".
 - Set the trigger position to zero.
3. To set the time reference point:
 - a) Press the [MENU] key.
 - b) Press the "TIME REF." softkey.
 - c) Use the universal knob in the Cursour/Menu section to adjust the value.

You can set the reference point from -6 divisions to +6 divisions with 0 being the center and default setting.

5.3 Acquisition Setup

During an acquisition, the R&S RTC1000 captures the signal and converts it to digital samples. The digital samples are processed according to the acquisition settings. The result is a waveform record that is displayed on the screen and stored in memory.

The rate of recording waveform samples - the number of waveform samples per second - is the sampling rate. The higher the sampling rate, the better the resolution and the more details of the waveform are visible.

A sufficient resolution is essential for correct reconstruction of the waveform. If the signal is undersampled, aliasing occurs - a false waveform is displayed. To avoid aliasing and accurately reconstruct a signal, the sampling rate must be at least 3 to 5 times the fastest frequency component of the signal.

5.3.1 RUN/STOP and SINGLE

In run mode, signals are shown on the screen according to the selected acquisition and trigger conditions. Previously captured signals are discarded with each new acquisition.

- ▶ To stop the acquisition, press the [RUN/STOP] key.

Now the captured signal remains on the screen and you can analyze it. The key is illuminated in red.

- ▶ To capture and display exactly one waveform record, press the [SINGLE] key in the Trigger section.

5.3.2 Acquisition Settings

Acquisition settings define the processing of the captured samples in the instrument. The current sampling rate is shown on top of the grid.

- ▶ To adjust acquisition settings, press the [ACQUIRE] key.

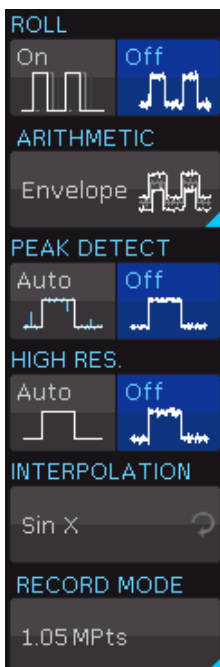

ROLL

Enables the roll mode.

The roll mode displays the untriggered, continuous signal. The roll mode moves the captured input data on the display from the right to the left. The instrument shows the waveform immediately, without waiting for the complete acquisition of the waveform record.

The roll mode is intended for slow signals and requires signals slower than 200 kHz.

If roll mode is active, zoom is not available.

ARITHMETIC

Opens a menu to define how the waveform is built from the captured samples.

- "REFRESH" Captures and displays of the samples of the signal. Usually, signals are displayed optimally with this acquisition mode but very short glitches can remain undiscovered by this method.
- "ENVELOPE" Displays the normal sample of the signal, and also the maximum and minimum values of each sampling interval. Over time, these values create an envelope surrounding the signal.
- "AVERAGE" The average is calculated from the data of the current acquisition and some consecutive acquisitions before. The method reduces random noise. It requires a stable, triggered and repetitive signal. Turn the universal knob to set the number of acquisitions for average calculation (2 to 1024 in powers of 2).

"SMOOTH"	Calculates the mean value from several adjacent sampling points. The result is a smooth waveform. This function is used for non-periodic signals.
"FILTER"	Activates a low pass filter with adjustable cut-off frequency to suppress unwanted high frequency interferences. The cut-off frequency depends on the sampling rate. Turn the universal knob to adjust the cut-off frequency. The minimum setting is 1/100 of the sampling rate and the maximum value is 1/4 of the sampling rate.

PEAK DETECT

Peak detection is used for large time base settings to detect even short signal changes.

The following conditions must be met to activate the peak detect mode:

- Function "HIGH RES." is deactivated.
- No serial or parallel bus is active.

If "PEAK DETECT" is set to "Auto", the instrument selects the best peak detection mode depending on the time base and sampling rate. The minimum and the maximum of each sampling interval are recorded as data pairs, and the other samples are discarded. Thus the instrument can detect fast signal peaks at slow time scale settings that would be missed with other acquisition modes.

HIGH RES.

The average of n captured sample points is recorded as one waveform sample. High resolution reduces the noise, the result is a more precise waveform with higher vertical resolution.

The following requirements must be met to activate the high-resolution mode:

- Sampling rate is smaller than the maximum sampling rate (no interlace mode)
- Peak detection is deactivated
- No active logic probe
- No serial or parallel bus is active

INTERPOLATION

Selects the interpolation method to display the acquired data points:

"Sin x"	Two adjacent waveform points are connected by a $\sin(x)/x$ curve, and also the adjoining sample points are considered by this curve. This interpolation method is the default method. It is precise and shows the best signal curve.
"Linear"	Uses a line to connect acquired data points.
"Sample-Hold"	Allows a more precise assessment of the position for the acquired data points. For each sampling interval, the Y-value of the sample point is considered as constant, and the intervals are connected with vertical lines. Thus, you see the discrete values of the ADC.

RECORD MODE

See [Chapter 5.3.3, "Record Modes"](#), on page 44.

5.3.3 Record Modes

The R&S RTC1000 provides several record modes, which combine the setting of the sampling rate, the memory depth, and the waveform rate.

MAX. WFM. RATE

Memory depth and sampling rate are adjusted to obtain the maximum trigger repeat rate. The oscilloscope displays the maximum number of acquisitions per second in the signal window. Each column in the signal window displays a captured date. When peak detection is activated, each column displays a pair of min/max values. The R&S RTC1000 displays a signal window of 600x400 pixels (without zoom), which translates into 600 data points per acquisition. When peak detection is activated, 600 pairs of min/max values or 1,200 data values are displayed.

The memory depth corresponds to the displayed time window (time base x 10 grid sections in horizontal direction) multiplied by the current sampling rate. The minimum value is determined by the maximum sampling rate and the maximum signal repeat rate of the oscilloscope. The displayed sampling rate corresponds to the current sampling rate divided by the amount of data skipped while reading out from the acquisition memory. If peak detection is activated, the displayed sampling rate corresponds to the current sampling rate.

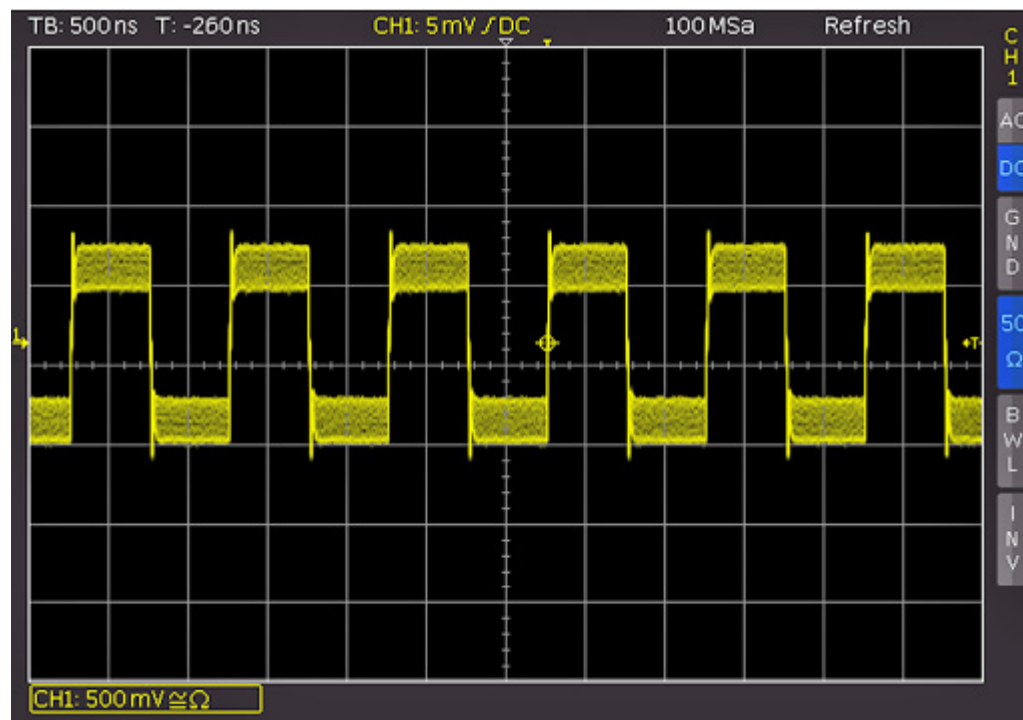

Figure 5-4: AM modulated signal with maximum repeat rate

MAX. SA. RATE

The instrument sets the maximum sampling rate while using the maximum memory available. Thus, it displays the maximum amount of data. Each column in the signal

window displays up to 40 detected data values (limited by processor performance). How much data is displayed depends on the displayed time window and the current sampling rate. If peak detection is activated, each column displays up to 20 pairs of min/max values. The memory depth always corresponds to the maximum acquisition memory. The displayed sampling rate is identical with the current sampling rate. Peak detection is used if the displayed time window contains more data than $40 * \text{signal window columns}$ in the acquisition memory or min/max data in the acquisition memory.



If the maximum sampling rate is selected, the entire oscilloscope memory can only be read out in "STOP" mode.

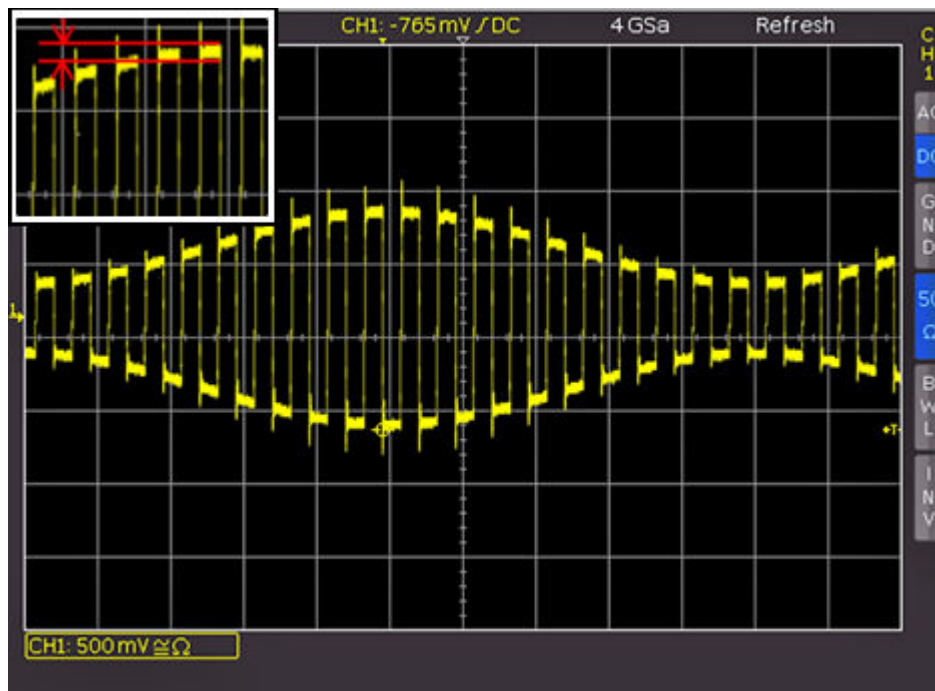

Figure 5-5: Example figure of AM modulated signal with max. sampling rate

AUTOMATIC

"AUTOMATIC" is the default setting and offers the best compromise between maximum repeat rate and maximum sampling rate (selection of memory depth). Each column in the signal window displays up to 10 captured data values. How much data is displayed depends on the displayed time window and the current sampling rate. When peak detection is activated, each column displays up to 5 pairs of min/max values. The memory depth is at least twice as much as the storage capacity set for the maximum repeat rate (limited by the maximum acquisition memory). The displayed sampling rate corresponds to the current sampling rate divided by the amount of data skipped while loading from the acquisition memory. If peak detection is activated, the displayed sampling rate corresponds to the current sampling rate.

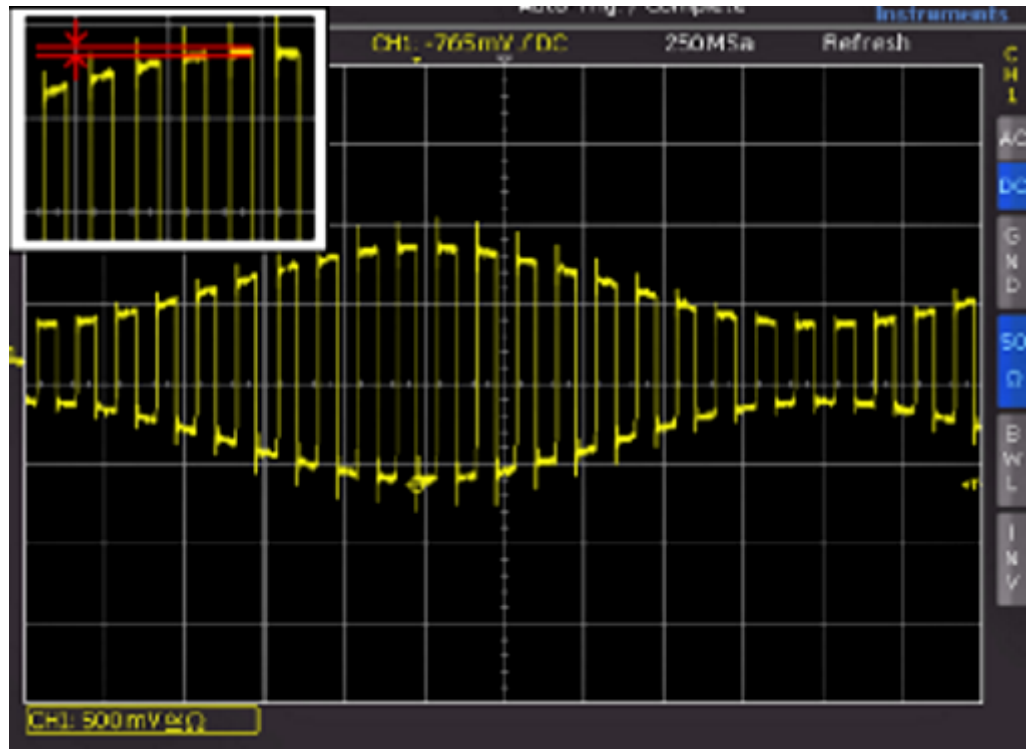

Figure 5-6: Example figure of AM modulated signal with automatic setting

5.3.3.1 Comparison of Record Modes

In all record modes, the sampling rate used to write to the acquisition memory is the same. In "STOP" mode, it is also possible to change menu items. Changing the record mode does not impact the current memory depth but the amount of displayed data is adjusted. Peak detection is also activated in "STOP" mode. If the time base allows of the display of each sample point, all three settings behave identically (except used memory depth and signal update rate). Advantages and disadvantages of the record modes are listed in [Table 5-1](#).

The record mode menu replaces the adjustable memory depth, a standard for other oscilloscopes. An adjustable memory depth requires that users understand the relation between memory depth, time base and sampling rate and to evaluate advantages and disadvantages. With the record mode menu, the oscilloscope always captures signals with the maximum sampling rate. Zoom in and zoom out in stop mode is always possible.

Table 5-1: Advantages and disadvantages of record modes

Setting	Advantages	Disadvantages	Application
Maximum waveform rate	<ul style="list-style-type: none"> • Many captures in one image • Rare events can be detected more quickly in connection with persistence • Quick response to operation or change in signal • Low noise band 	<ul style="list-style-type: none"> • High aliasing risk • Low accuracy of details • Low accuracy of measurements due to reduced amount of data 	<ul style="list-style-type: none"> • Search for rare events • Displaying modulated signals
Maximum sample rate	<ul style="list-style-type: none"> • Maximum accuracy of details • Lowest aliasing risk • High accuracy of measurements 	<ul style="list-style-type: none"> • Slow response to operation or change in signal • Low signal update rate • Higher visibility of noise 	<ul style="list-style-type: none"> • For signals with high frequency parts • Assessment of small signal details
Automatic	<ul style="list-style-type: none"> • Average signal update rate • Reasonable smooth operation • Good accuracy of measurements • Low noise band 	<ul style="list-style-type: none"> • Aliasing is possible 	<ul style="list-style-type: none"> • Default application

5.3.4 Interlace Mode

In interlace mode, only one channel is active, and the ADC and storage of two channels are connected. This connection doubles the sampling rate and the acquisition memory. A channel is also considered active if it is deactivated but serving as the trigger source.

The interlace mode is activated automatically if the following conditions are met:

- No logic probe is active
- No serial or parallel bus is active
- Logic trigger is not used

6 Trigger

Triggering means to capture the interesting part of the relevant waveforms. Choosing the right trigger type and configuring all trigger settings correctly allows you to detect various incidents in signals.

A trigger occurs if the trigger conditions are fulfilled. The instrument acquires continuously and keeps the sample points to fill the pretrigger part of the waveform record. When the trigger occurs, the instrument continues acquisition until the posttrigger part of the waveform record is filled. Then it stops acquiring and displays the waveform. When a trigger is recognized, the instrument does not accept another trigger until the acquisition is complete.

Trigger conditions include:

- Source of the trigger signal (channel)
- Trigger type and its filter setup
- Trigger mode

In addition, the trigger position and the reference point are important to display the interesting part of the signal. See [Chapter 5.2, "Horizontal Setup"](#), on page 40.

The trigger level and position are marked in the grid. The markers have the color of the trigger source. Information on the most important trigger settings is shown above the grid, in the middle of the information bar.

6.1 Setting Up the Trigger

1. To activate the normal trigger mode, press the [AUTO/NORM] key.
A red LED highlights the key if normal mode is active.
2. To select the trigger source:
 - a) Press the [SOURCE] key.
 - b) Select the trigger source in the menu.
3. To configure the trigger type:
 - a) Press the [TYPE] key.
 - b) Select the trigger type.
 - c) Press the [FILTER] key.
 - d) Define the trigger condition.
4. To define the hold-off time:
 - a) Press the [TYPE] key.
 - b) Press the "HOLD OFF" softkey to enable the hold-off.
 - c) Turn the universal knob in the Cursour/Menu section to adjust the value.

6.2 General Trigger Settings

The keys in the Trigger section provide all functions to set up the trigger.

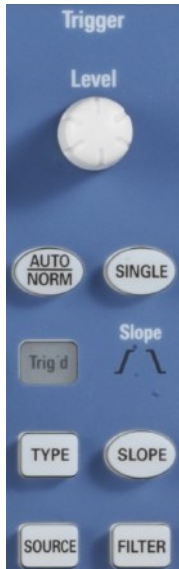

[AUTO/NORM] trigger modes

Sets the trigger mode. The Trigg'd LED lights up if the instrument found a trigger event.

"AUTO"

In "AUTO" mode, the screen always displays a signal. If a signal fulfills the trigger conditions, the oscilloscope synchronizes with this event and triggers when the condition is met. If a signal that does not fulfill the trigger condition, the oscilloscope generates a trigger event. With auto mode, you can see the input signals at any time, regardless of the trigger condition.

"NORMAL"

In "NORMAL" mode, the signal is displayed if the trigger condition is met. The instrument shows the signal that was triggered last. If no trigger occurs, no waveform is acquired and the last triggered waveform is displayed. If no waveform was captured before, nothing is displayed.

[SINGLE]

To ensure that only a signal that meets the trigger condition is detected and displayed, press the [SINGLE] key. The key is highlighted in white when the SINGLE mode is active. In normal trigger mode, the trigger system is now activated, and the [RUN/STOP] key is blinking. If the trigger condition is fulfilled, the instrument triggers, data is stored and displayed, and the oscilloscope switches to "STOP" mode (red [RUN/STOP] key).

[Type]

Opens a menu to select the trigger type, and to set the hold-off time.

The following trigger types are available:

- [Chapter 6.3, "Edge Trigger"](#), on page 50
- [Chapter 6.4, "Pulse Trigger"](#), on page 52
- [Chapter 6.5, "Logic Trigger"](#), on page 53
- [Chapter 6.6, "Video Trigger"](#), on page 56
- Serial trigger if at least one of the protocol options R&S RTCK1, R&S RTCK2, or R&S RTCK3 is installed.

HOLD OFF

The trigger hold-off time indicates how long the oscilloscope waits after a trigger event until the trigger system is ready again. The next trigger occurs only after the hold-off time has passed. Hold-off helps to obtain stable triggering when the oscilloscope is triggering on unwanted events. Changing the time base does not impact the selected hold-off time.

The hold-off time is set in the "Trigger Type" menu.

[SOURCE]

Opens a menu to set the trigger source. You can trigger on:

- An analog channel.
- A digital channel if option R&S RTCB1 is installed.
- The power supply frequency ("AC LINE"). The trigger signal is extracted internally from the power supply.
- An external signal that is connected to the external trigger input. Select the coupling of the trigger signal: AC or DC.

[SLOPE]

Selects the slope for the edge trigger, or the polarity for the pulse trigger. The selection is indicated by the Slope LEDs.

[FILTER]

Opens a menu to set up the trigger condition for the selected trigger type.

6.3 Edge Trigger

The edge trigger is the most common trigger type. The trigger occurs when the signal of the trigger source passes the trigger level in the specified direction (slope).

1. Select [TYPE] > "EDGE".
2. To set the slope, press the [SLOPE] key repeatedly.
The selected slope is shown above the key, and on top of the grid in the display.
3. To set the trigger level, turn the [Level] knob.
4. Select [FILTER].

The [FILTER] settings select how to couple the signal for the trigger circuit.

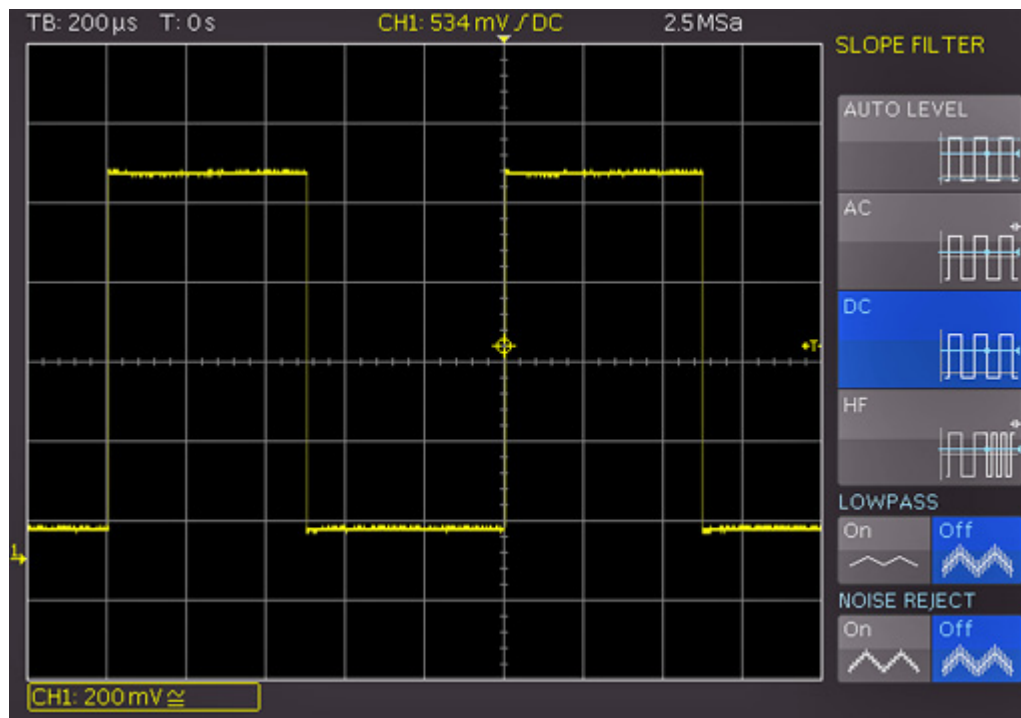
**AUTO LEVEL**

Automatic filter setting (default setting).

AC

The trigger signal is coupled through a 5 Hz high-pass filter which suppresses the DC portion of the trigger signal. With a changing DC portion, the trigger level remains at the set point in the AC signal.

DC

The trigger signal is coupled to the trigger circuit with all signal portions (AC and DC voltage).

HF

The trigger signal is coupled through a high-pass filter with a minimum cut-off frequency (-3 dB) of 30 kHz. Use this coupling type only with high frequency signals.

LOWPASS

The trigger signal is coupled through a low-pass filter with an upper cut-off frequency of 5 kHz. This filter removes higher frequencies and is available with AC and DC coupling.

NOISE REJECT

A low-pass filter with a cut-off frequency of 100 MHz improves the noise performance for the trigger amplifier. This filter removes higher frequencies and is available with AC and DC coupling.

Note: The coupling types "LOWPASS" and "NOISE REJECT" cannot be activated simultaneously.

6.4 Pulse Trigger

The pulse trigger finds specific pulse widths of positive or negative pulses or on pulse width ranges. If a pulse on the trigger source fulfills the trigger condition, the oscilloscope triggers on the trailing slope. For a positive pulse, it triggers on the falling slope, and for a negative pulse on a rising slope.

1. Select [TYPE] > "PULSE".
2. To set the polarity, press the [SLOPE] key repeatedly.
The selected polarity is shown above the key, and on top of the grid in the display.
3. To set the trigger level, turn the [Level] knob.
4. Select [FILTER].

The filter settings define the pulse direction and length for the pulse trigger:

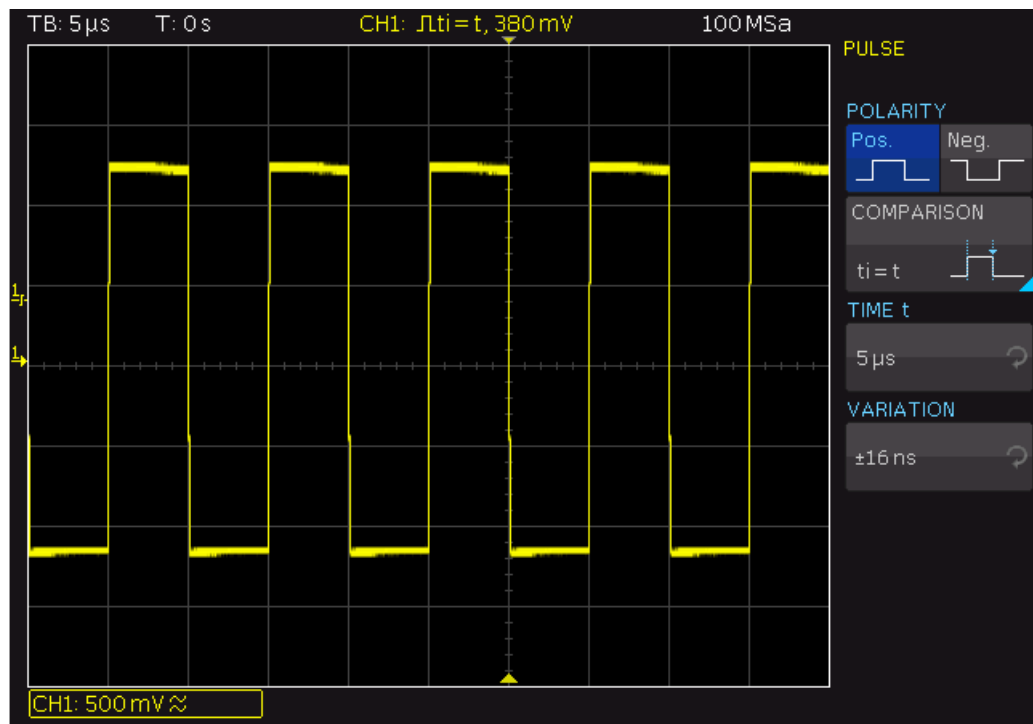

TIME t , TIME t_1 , TIME t_2 , VARIATION

Set the reference pulse length depending on the selected comparison.

The comparison time can be set between 16 ns to 10s. For values up to 1 ms, the resolution is 2 ns. and for any value greater than 1 ms the resolution is 1 μ s.

The deviation can be set from ± 8 ns up to 657.5 μ s with a resolution of 8 ns.

POLARITY

Sets the polarity, alternatively to the [SLOPE] key. For positive pulses, you define the width from rising to falling slopes, and accordingly for negative pulses from falling to rising slopes. Consequently, the trigger always occurs on the second slope of the pulse.

COMPARISON

Sets how the measured pulse width is compared with the given limits.

" $t_i > t$ "	Triggers on pulses longer than the reference time t .
" $t_i < t$ "	Triggers on pulses shorter than the reference time t .
" $t_i = t$ "	Triggers on pulses equal to the reference time t . The reference time is a combination of time t plus the deviation.
" $t_i \neq t$ "	Triggers on pulses unequal to the reference time t . The reference time is a combination of time t plus the deviation.
" $t_1 < t_i < t_2$ "	Triggers on pulses shorter than the reference time t_2 and longer than the reference time t_1 .
"Not($t_1 < t_i < t_2$)"	Triggers on pulses longer than the reference time t_2 and shorter than the reference time t_1 .

6.5 Logic Trigger

Using the logic trigger (also known as pattern trigger), you can trigger on any logic combination of active input channels. The logic trigger supports you in verifying the operation of digital logic when MSO option R&S RTCB1 is installed.

You can also set a time limitation to the pattern. Thus you can trigger on bus patterns of parallel buses.

You can test all settings in the logic trigger without connecting the logic probe.

Before you set up the logic trigger, make sure that the thresholds are set correctly.

- Analog channels: in the "Channel" > "Threshold" menu, see ["THRESHOLD menu"](#) on page 37.
- Logic channels: in the "LOGIC POD" menu, see

The pattern is configured in the "SOURCE" menu. The time limitation is configured in the "FILTER" menu.

6.5.1 Logic Pattern

In the "SOURCE" menu, you define the logic pattern. The configuration is shown in a window.

1. Select [TYPE] > "LOGIC".
2. Press the [SOURCE] key.

3. Turn the Universal knob to select the "LOGIC CHANNEL" for which you want to set the logic state.
4. Press "STATE" repeatedly until the required state is selected.
5. Repeat steps 3 and 4 for each channel of the pattern.
6. Select the logic "COMBINATION" of the channels.
7. Select whether you want to trigger on the true or false pattern: "TRIGGER ON".

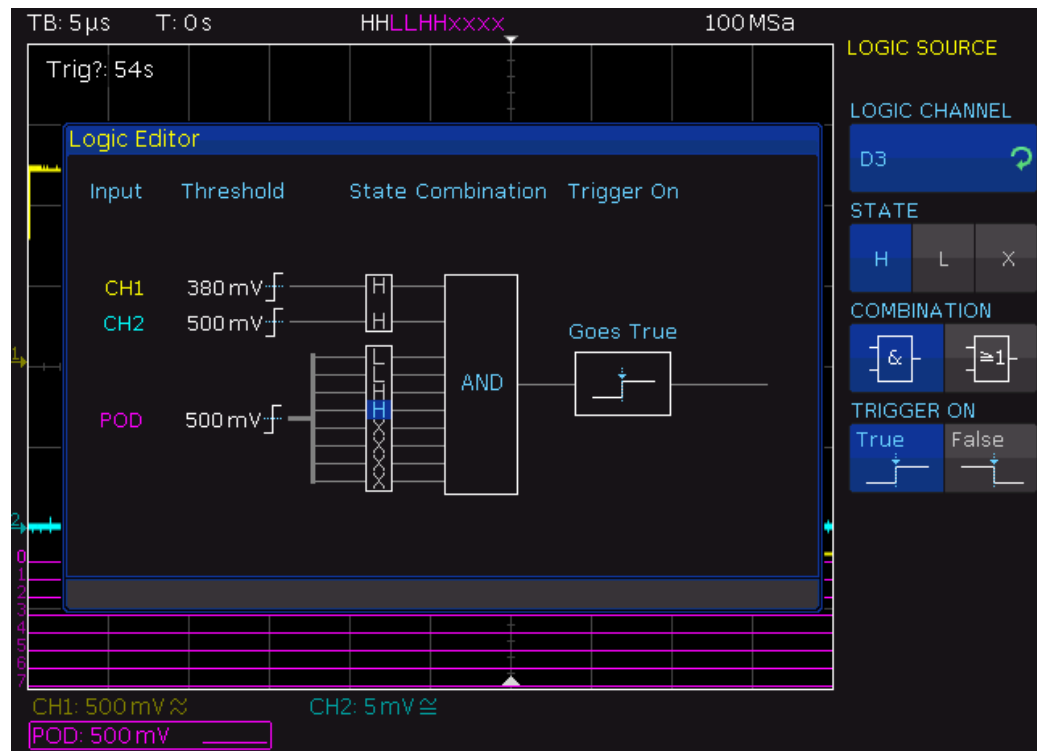

Figure 6-1: Logic trigger pattern setup

LOGIC CHANNEL

Selects the channel for which you want to set the logic state. The setting is always active.

STATE

Selects the channel state: high ("H"), low ("L") or don't care ("X").

COMBINATION

Sets the logic combination of the channels:

- "AND" The states of all channels must be met simultaneously to produce a logic high ("H", true) as a result.
- "OR" At least one of the defined states must be met to produce a logic high ("H", true) as a result.

TRIGGER ON

Selects whether the trigger is generated at the beginning ("TRUE") or the end of the fulfilled logic condition ("FALSE").

6.5.2 Time Limitation

To set a time limitation for the pattern, you have several possibilities. They are similar to the setting of a pulse width, see [Chapter 6.4, "Pulse Trigger"](#), on page 52.

1. Select [TYPE] > "LOGIC".
2. Press the [FILTER] key.
3. To enable the time limit, press "DURATION".

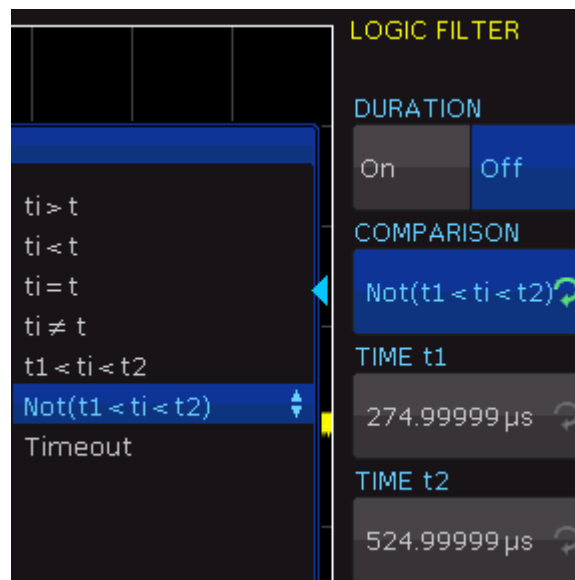

4. Set the "COMPARISON" and the reference "TIME t".

The following settings are possible:

- "Timeout" and "TIME t".
Define a minimum time during which the signals match the pattern condition.
- " $t_i > t$ " or " $t_i < t$ " and "TIME t"
Triggers if the pattern condition changes before or after the specified time.
- " $t_i = t$ ", "TIME t" and "Variation":
Triggers if the pattern condition is fulfilled for a duration $time\ t \pm variation$.
- " $t_i \neq t$ ", "TIME t" and "Variation":
Triggers if the pattern condition is fulfilled for a duration shorter than $time\ t - variation$, or longer than $time\ t + variation$.
- " $t_1 < t_i < t_2$ ", "TIME t1" and "TIME t2"
Triggers if the pattern condition is fulfilled for a duration between time t1 and time t2. These settings are an alternative setting to the definition with "Width =" and variation. The time values are interdependent and adjusted accordingly.
- "Not($t_1 < t_i < t_2$)", "TIME t1" and "TIME t2"

Triggers if the pattern condition is fulfilled for a duration shorter than time $t1$ $t1''$, or longer than time $t2$. These settings are an alternative setting to the definition with "Width =" and variation. The time values are interdependent and adjusted accordingly.

6.6 Video Trigger

The video or TV trigger is used to analyze analog baseband video signals. You can trigger on baseband video signals from standard definition and high definition standards connected to an analog channel input.

1. Select [TYPE] > "VIDEO".
2. Select [FILTER].

The following settings can be selected in the video filter menu:

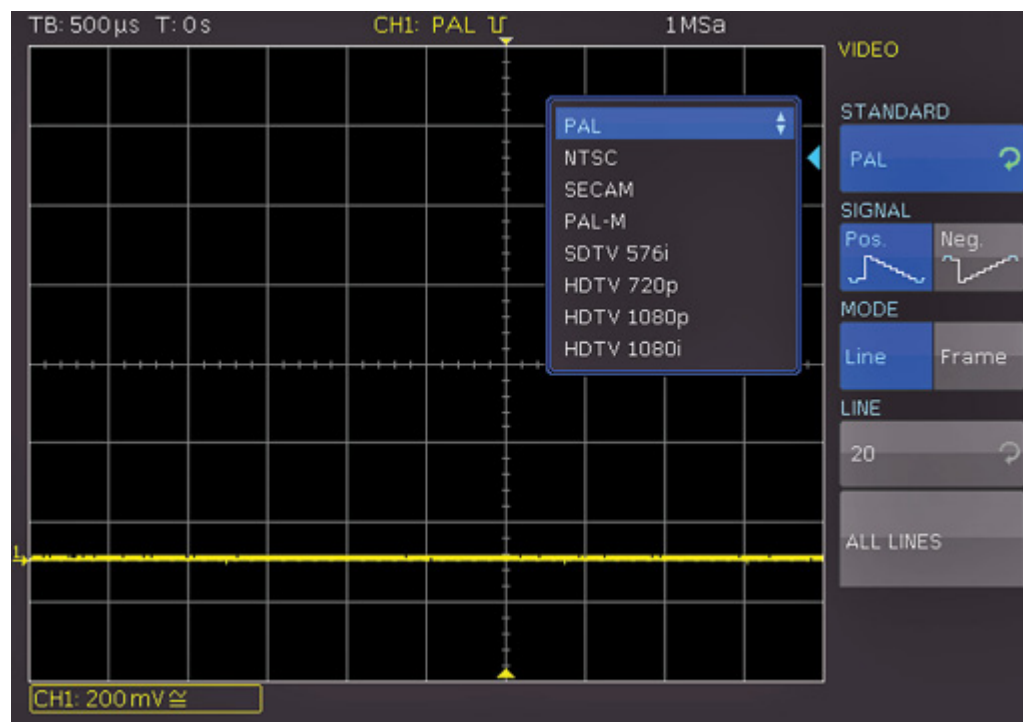

Figure 6-2: Video trigger menu

STANDARD

Selects the television standard.

- PAL
- NTCS
- SECAM
- PAL-M
- SDTV 576i Interlaced

- HDTV 720p Progressive
- HDTV 1080p Progressive
- HDTV 1080i Interlaced

SIGNAL

Selects the polarity of the sync pulse (positive or negative). With positive video modulation, when the highest brightness is represented by the maximum signal voltage in the image), the synchronization pulses are negative. If the modulation is negative, sync pulses are positive. The edges of the sync pulses are used for triggering, therefore incorrect polarity setting causes a sporadic triggering by the video information.

MODE

Selects line or frame triggering.

- | | |
|---------|---|
| "LINE" | Triggers on the start of video lines. You can define the exact line between 1 and 625, or trigger on all lines. |
| "FRAME" | Triggers on the start of half frames, either on odd or on even half frames. |

6.7 Trigger Out Pulses

You can output a pulse for each trigger event at the [AUX OUT] connector for each trigger event, thus issuing the trigger frequency.

1. Press the [UTIL] key in the Vertical section of the control panel.
2. On page 2|2, select "ACQ. TRIGGER EV."

6.8 External Trigger Input

You can use an external trigger signal, for example, for CS (chip select) of a SPI BUS. The external trigger signal is displayed as green line.

1. Press the [POD] key.
2. To activate the external trigger, press the "EXT" softkey.
3. Press the [MENU] key in the Vertical section.
4. Press the "EXT. THRESHOLD" softkey and adjust the threshold for the external trigger signal

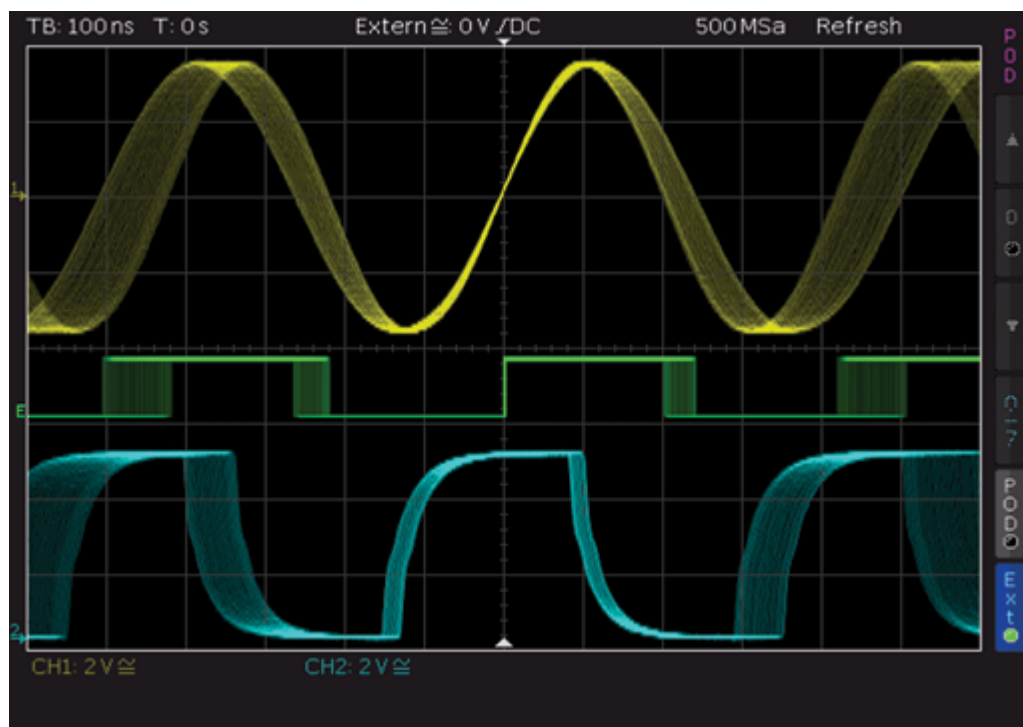

Figure 6-3: External trigger signal

7 Analysis

The R&S RTC1000 features various functions to analyze waveforms on the display.

• Zoom Function	59
• Marker Function	61
• XY-Display	63
• Mathematics	64
• Frequency Analysis (FFT)	72
• Pass/Fail Test Based on Masks	76
• Component Test	78
• Digital Voltmeter	82

7.1 Zoom Function

The R&S RTC1000 features a memory depth of 1 MSa (2 MSa in interlaced mode). Thus, the instrument can record long and complex signals. To analyze these records in detail, use the zoom function.

- ▶ Press the [ZOOM] key in the Horizontal section.

The screen is divided into two windows. The upper window displays the entire time base window. The lower window is the zoom window, it shows an enlarged section of the upper window. The enlarged section is marked by two cursors in the upper window. If several channels are active, all displayed channels are zoomed simultaneously by the same factor and at the identical position.

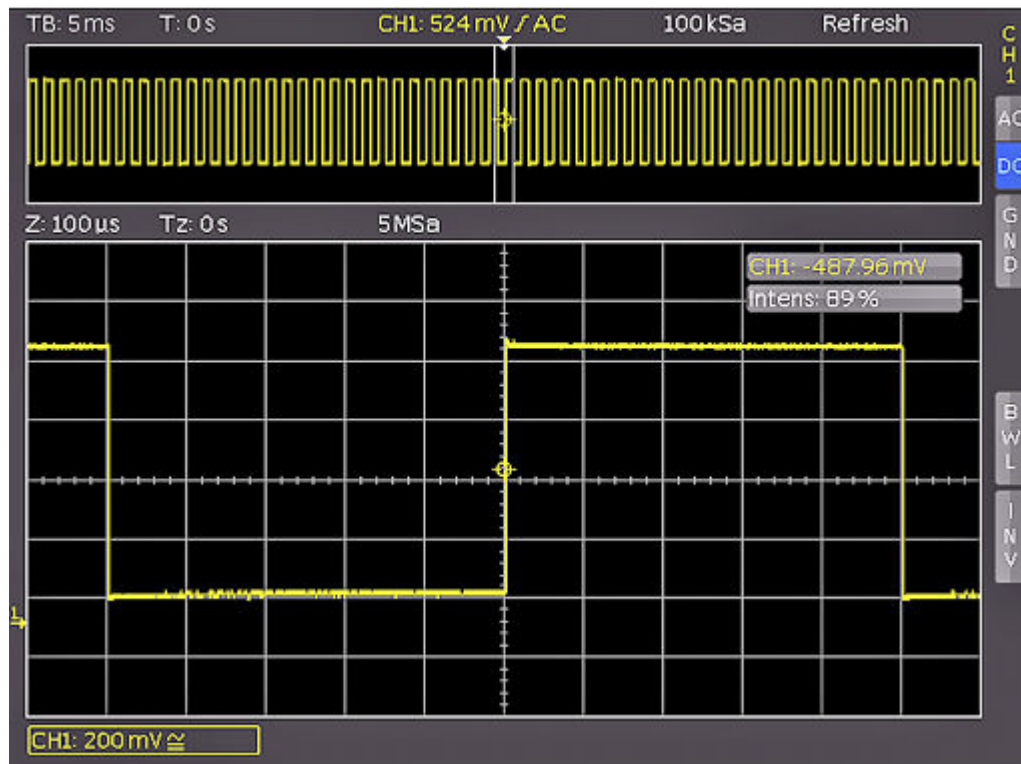

Figure 7-1: Zoom window with 100 μs per division, the zoomed time window is 12 ms

Above the zoom window, you see the zoom time base "Z" (zoom factor), which determines the width of the zoom area (12 divisions x scaling per division). "Tz" indicates the zoom time and determines the position of the zoom area. The time base setting of the upper window is shown in gray, while the zoom time base is marked in white.

To adjust the zoom settings

1. If the zoom time base is marked in white, the zoom window is active. Turn the [Scale] knob in the Horizontal section to change the zoom time base "Z".
2. To move the position of the zoomed section "Tz", turn the [Position] knob in the Horizontal area.

To set the time base in the upper window

1. Press the [Scale] knob in the Horizontal section.
Now, the time base setting is highlighted in white and the zoom time base in gray. The upper window is active.
2. Turn the [Scale] knob in the Horizontal section to change the time base of the original waveform "TB".
3. To move the trigger position, turn the [Position] knob in the Horizontal area.

The zoom function is not available in roll mode because the signal values of the X axis are always captured with the maximum memory depth. The acquisition mode "NOR-

MAL" always stores more samples in the memory than what can be shown in the display. That explains that you can zoom in the signal using the memory data. The values in the Y axis (amplitude) can be scaled also in roll mode because they apply to a specified axis.

7.2 Marker Function

Markers allow you to highlight specific positions on the screen, e.g. a rising or falling slope, an unexpected signal value, or a search result. You can use the markers to identify areas of interest you want to zoom into, and quickly move through the data. You can set up to 8 time markers.

To set markers:

1. Press the [MENU] key in the Horizontal section.
2. Press the upper softkey to select "Marker".
The "Marker" menu is shown.
3. Press the [SET/CLR] key to set a time marker at the 6th division. This position is the center of the grid if menus are closed.
The time markers is a vertical line in gray-blue.
4. To move the signal including the set marker, turn the [Position] knob in the Horizontal section.
5. Identify an important signal position and set it to the center of the screen.
6. Press the [SET/CLR] key to set the marker to the identified position.

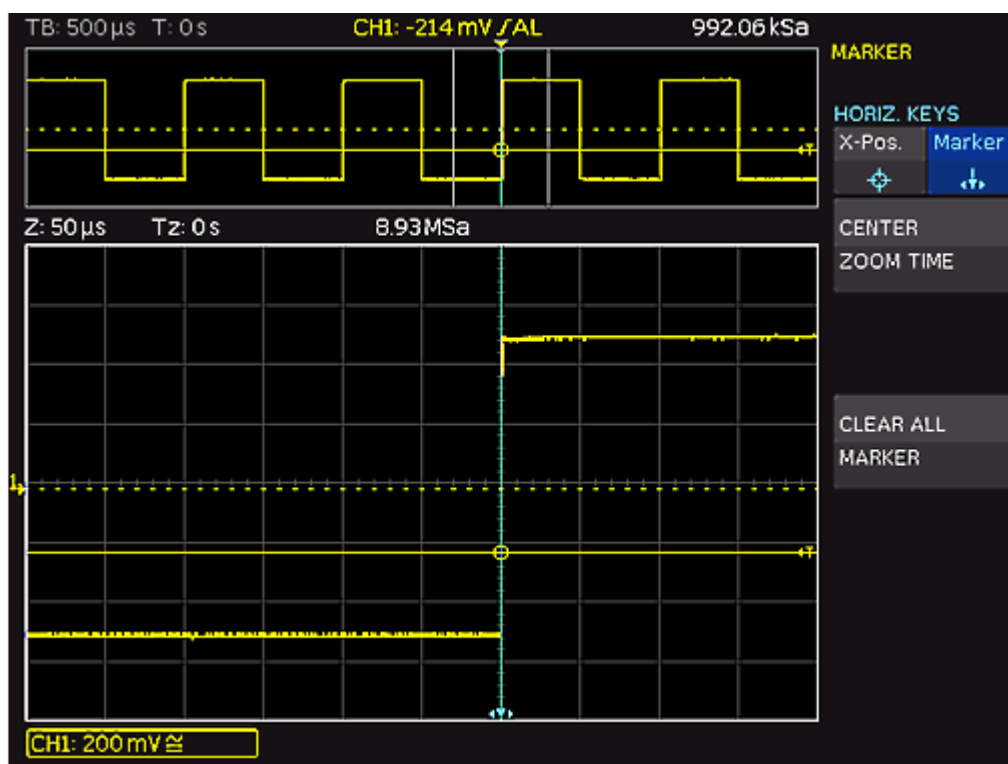

Figure 7-2: Marker in zoom mode

1. To toggle markers, use the [ARROW] keys. The selected marker is set to the center of the screen.
Thus, you can quickly compare marked signal sections in zoom mode.
2. To delete a marker, set it to the center of the screen. Press [SET/CLR].

The marker menu provides more functions.

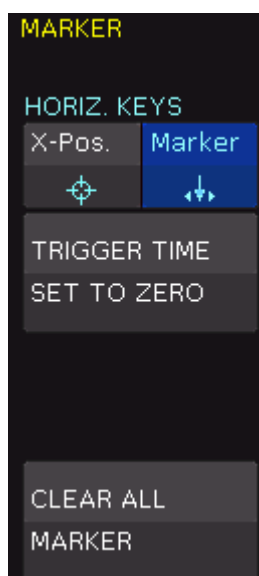

Figure 7-3: Marker menu

TRIGGER TIME SET TO ZERO

Sets the trigger time to 0 s.

CLEAR ALL MARKER

Deletes all defined time markers.

7.3 XY-Display

The XY-display combines the voltage levels of two waveforms in one diagram. The voltage level of the first signal is displayed in y-direction, and the voltage level of a second signal in x-direction. In other words, the time base x is replaced by amplitude values of a second source.

The resulting XY-display for harmonic signals is known as Lissajous figures. They are used to analyze frequency and phase position for the two signals, and to measure the phase shift. If the frequencies are nearly identical, the figure rotates. If the frequencies are identical, the figure stands still and the phase position can be deduced from its shape.

1. Activate both analog channels.
2. Press the [UTIL] key in the Vertical section.
3. On menu page 2|2, press "XY".
4. Assign the channels to the axis.

The display shows one large and two small diagrams. The large diagram shows the XY-display. The small diagrams show the sources for X and Y, the normal signal display as Y vs. time.

7.4 Mathematics

Math waveforms are calculated waveforms. The R&S RTC1000 provides two methods to use mathematics:

- With the Quick Mathematics (QM) function, you can create one math waveform with basic mathematical operators on channel 1 and channel 2.
- Using the advanced mathematics (MA), you can create up to five formulary sets. Each formulary set can include up to five equations. Equations provide more operators and more sources than the Quick Mathematics. Formulary sets can be saved and loaded for further use.

Mathematical functions track the changes of the source signals. They apply to the visible area of the screen. If a signal is cut off at the edge of the screen, the corresponding mathematical curve can also be truncated.

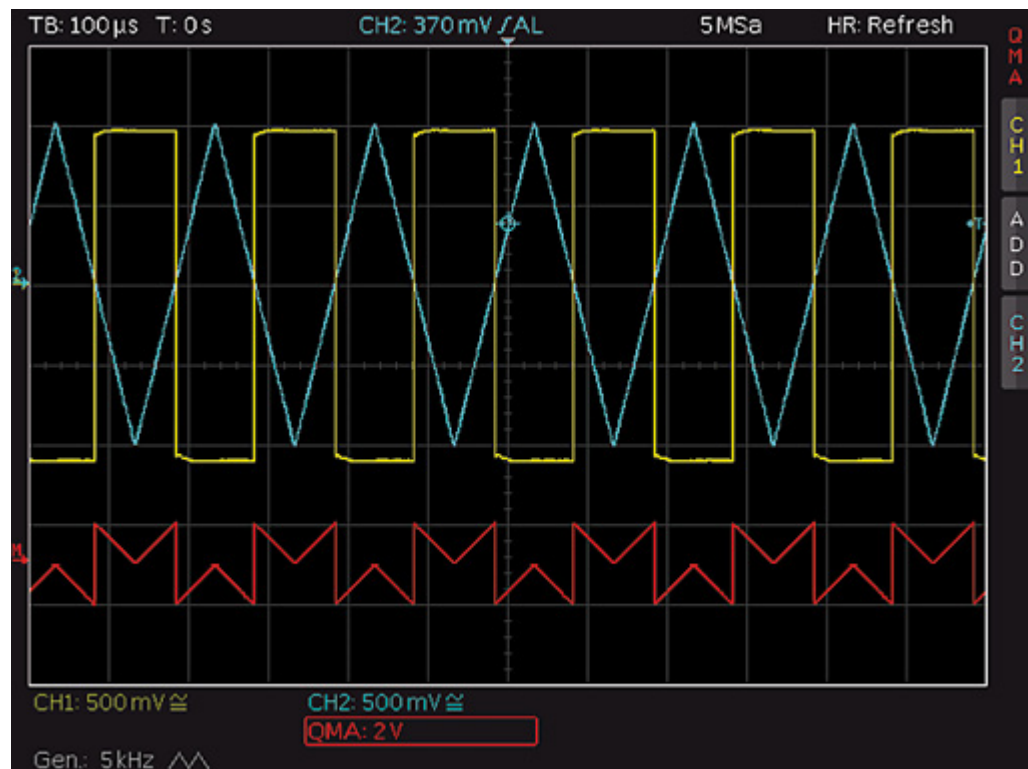

Figure 7-4: Example of a mathematical waveform

- To scale a mathematic waveform:
 - a) Select the math waveform.

- b) Turn the [Scale] knob in the Vertical section.

7.4.1 Quick Mathematics (QM)

Quick mathematics create one math waveform with basic mathematical operators on analog channels 1 and 2.

1. Press the [MATH] key in the Vertical section.
The short math menu opens.
2. Press the lowest softkey until "QM" is illuminated in red.

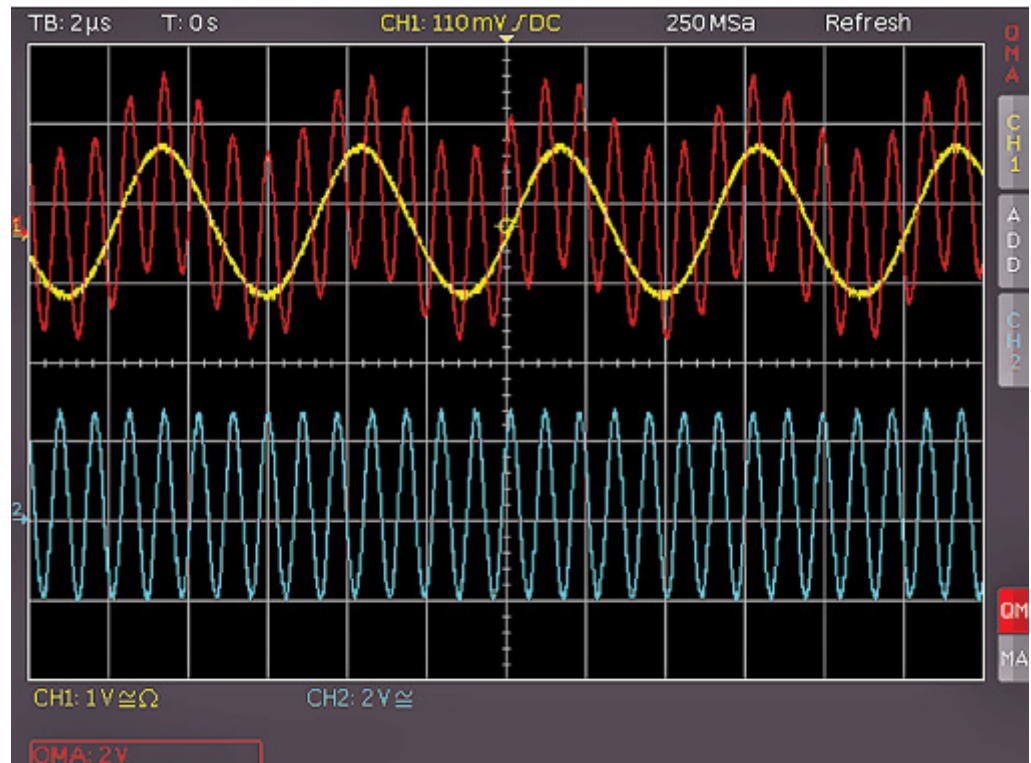

Figure 7-5: Quick Mathematics short menu

3. Configure the math function:
 - a) Press the upper softkey to choose the first operand (channel).
 - b) Press the second softkey to set the mathematical operation.
 - c) Press the third softkey to select the second operand (channel).

Tip: If you press the MENU key in the Vertical section, you see the complete menu.

The following mathematical operations can be selected:

ADD		Addition
SUB		Subtraction
MUL		Multiplication
DIV		Division

7.4.2 Advanced Mathematics

Using the advanced mathematics (MA), you can create up to five formulary sets. Each formulary set can include up to five equations. Equations provide more operators and more sources than the Quick Mathematics. Formulary sets can be saved and loaded for further use.

7.4.2.1 To Create a Formulary Set and Its Equations

1. Press the [MATH] key in the VERTICAL section.
The math short menu opens.
2. Press the lowest softkey until "MA" is illuminated in red.
3. Press the [MENU] key in the Vertical control panel.
The mathematics menu opens to select the formulary set and edit the equations.

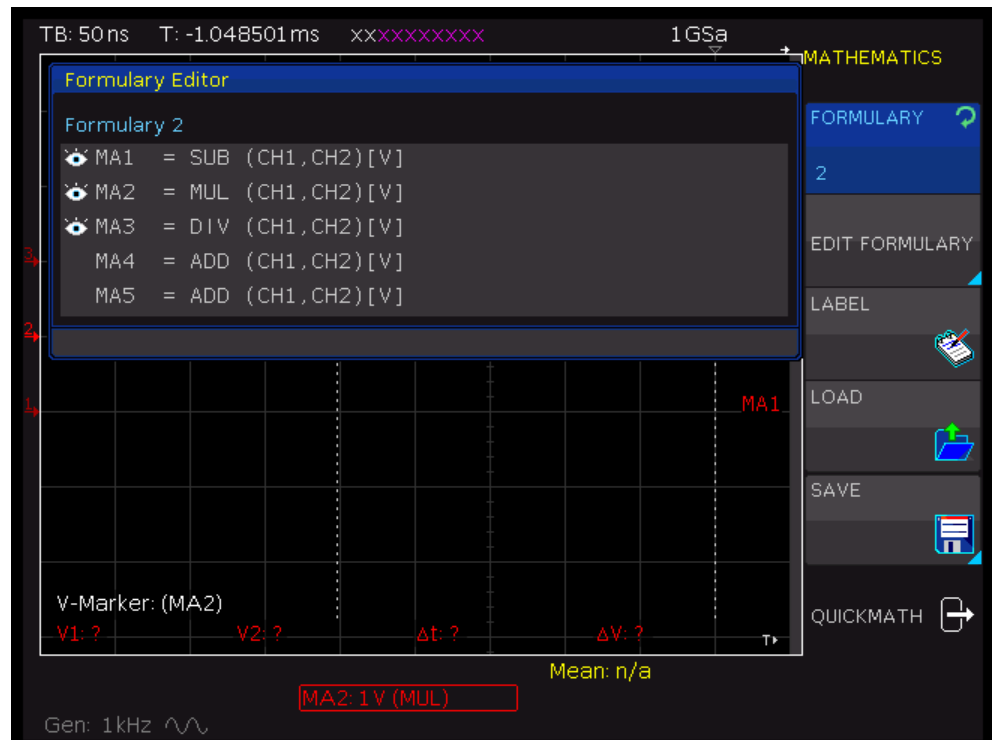

Figure 7-6: Mathematics menu

4. To select a formulary set, turn the Universal knob in the Cursor/Menu section.
5. To open the equation menu, press "EDIT FORMULARY".
6. To select an equation, turn the Universal knob in the Cursor/Menu section.
7. To add an equation:
 - a) Use the Universal knob to select "new..." in the editor.
 - b) Press "ADD".
 The new equation is added and can be edited.
8. To delete an equation from the formula set, press "DELETE".

7.4.2.2 To Edit Equations

If the equations are created, you define the mathematical calculation and the display options.

1. In the "EDIT FORMULARY" menu, select the equation.
2. Press the "EDIT" softkey until "Display" is selected.

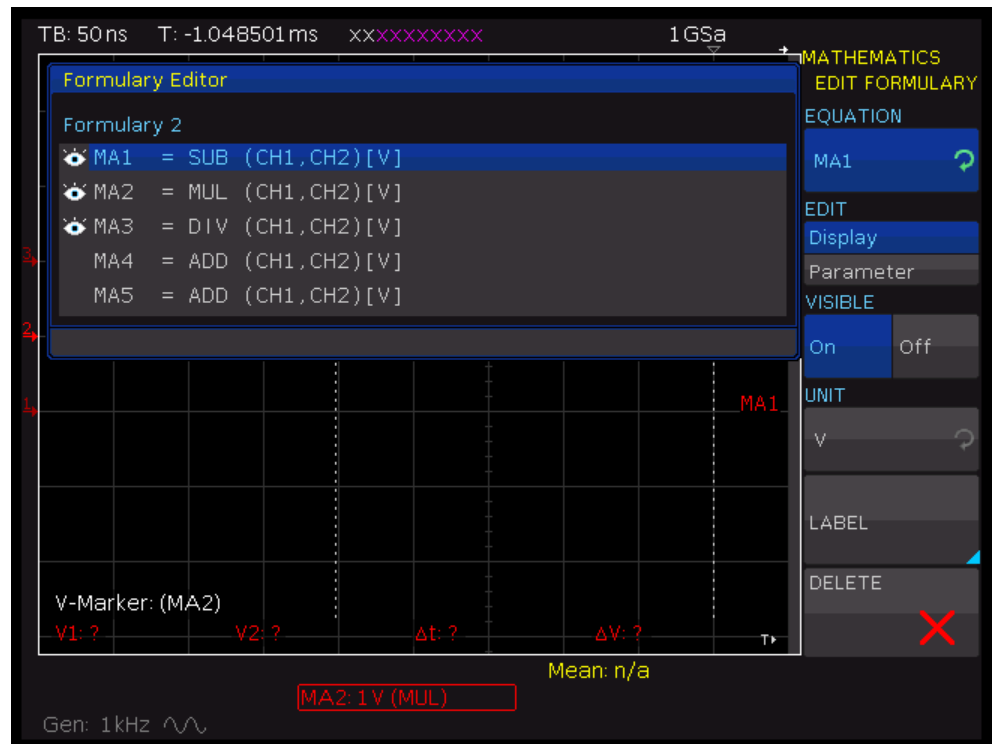

Figure 7-7: Display settings for equations

3. To activate the equation, press "VISIBLE" until "On" is selected.
An active visible equation is marked by an eye symbol in the formula editor, and it is listed in the short menu.
4. Press the "UNIT" softkey. Select the unit by using the Universal knob.
Various units for all usual calculations are available. The selected equation unit is applied to the channel description, cursor types and automatic measurement types.
5. To change the equation name:
 - a) Press the "LABEL" softkey.
 - b) To select a predefined label, press "LIBRARY".
 - c) To define a label, press the "EDIT LABEL" softkey. Enter the label on the keypad.

The equation name is listed in the formula set editor. It is also shown in the diagram instead of the generic labels "MA1" to "MA5".
6. Press the "EDIT" softkey until "Parameter" is selected.



Figure 7-8: Equation parameters (edit equation)

7. Press OPERATOR. Turn the Universal knob to select the operator.
8. To select the operands, press the "OPERAND" softkeys.
For each equation, the input channels CH1, CH2 and a constant are available as operands (sources). For the formula MA2, MA1 is added as source, for MA3 the additional sources are MA1 and MA2, for MA4 it is MA1, MA2 and MA3 and so on.
9. To set a constant, press "EDIT CONSTANT" and the [universal] knob in the CURSOR/MENU section to choose one of the following constants:

You can:

- Select a predefined constant (π , $2*\pi$, $0.5*\pi$).
- Customize a constant:
 - Select one of the constants "User: 1" to "User: 10".
 - Press NUMERIC INPUT
 - Press "VALUE". Use the Universal knob to select a numeric value.
 - Press "DECIMAL POINT". Set the position of the decimal point.
 - To enter an additional SI prefix, press "PREFIX".
 - Select a "UNIT".



Figure 7-9: Customize a constant

7.4.2.3 To Save and Load a Formulary Set

If all equations of a formulary set are defined, you can save the set.

1. Navigate to the "MATHEMATICS" menu.
2. Press "SAVE".
3. Save the formulary set:
 - a) Select the storage location with "STORAGE".
 - b) Enter the "FILE NAME".
 - c) Optionally, add a "COMMENT".
4. To use a saved formulary set, press "LOAD".

7.4.2.4 Example

This example shows the analysis of an electrical energy waveform. The voltage across the load is measured with differential probe and applied to channel 2. The current is measured with a current probe and applied to channel 1. Voltage is measured with an active differential probe and applied to channel 2.

To define the equation CURRENT

1. Press "EDIT FORMULARY" to open formulary set 1.
2. Select equation "MA1".

3. Select "EDIT" = "Display".
4. Assign the unit "A" (Ampere) to the equation by pressing "UNIT".
5. Press "LABEL" and enter *CURRENT*.
6. Select "EDIT" = "Parameter".
7. Select "CH1" as "OPERAND 1" and "Const." as "OPERAND 2".
8. Press "EDIT CONSTANT" to define the constant: "NUMERIC INPUT" = 0.1.



Figure 7-10: Definition of the current equation

The correct scaling and the units for cursors and automatic measurements are defined.

To define the POWER equation

1. Add a new equation "MA2" to formulary set 1.
2. Select "EDIT" = "Parameter".
3. Select "Multiplication" as "OPERATOR", "CURRENT" as "OPERAND 1" and "CH2" as "OPERAND 2".
4. Select "EDIT" = "Display".
5. Assign the unit "W" (Watt) to the equation.
6. Press "LABEL" and enter *POWER*.

To define the ENERGY equation

1. Add a third equation "MA3" to formulary set 1.
2. Select "EDIT" = "Parameter".
3. Choose "Integral" as "OPERATOR" and "POWER" as "OPERATOR 1".



Figure 7-11: Definition of the power equation

4. Select "EDIT" = "Display".
5. Assign the unit "J" (Joule) to the equation.
6. Press the softkey "LABEL" and enter *ENERGY*.

Now, all definitions are completed and the results can be displayed and analyzed. The math analysis can be performed with cursor or automatic measurement functions. All measurement results are correctly shown with correct units: Ampere, Watt, and Joule.

7.5 Frequency Analysis (FFT)

The fast Fourier transformation (FFT) in an oscilloscope works differently than in a spectrum analyzer. The FFT calculation is affected by the time base setting, and by the available number of used acquired data points. You can include up to 128k point in the FFT. The FFT is not suitable for the analysis of slow signals (Hz-range).

- ▶ To start the FFT, press the [FFT] key in the Analysis section

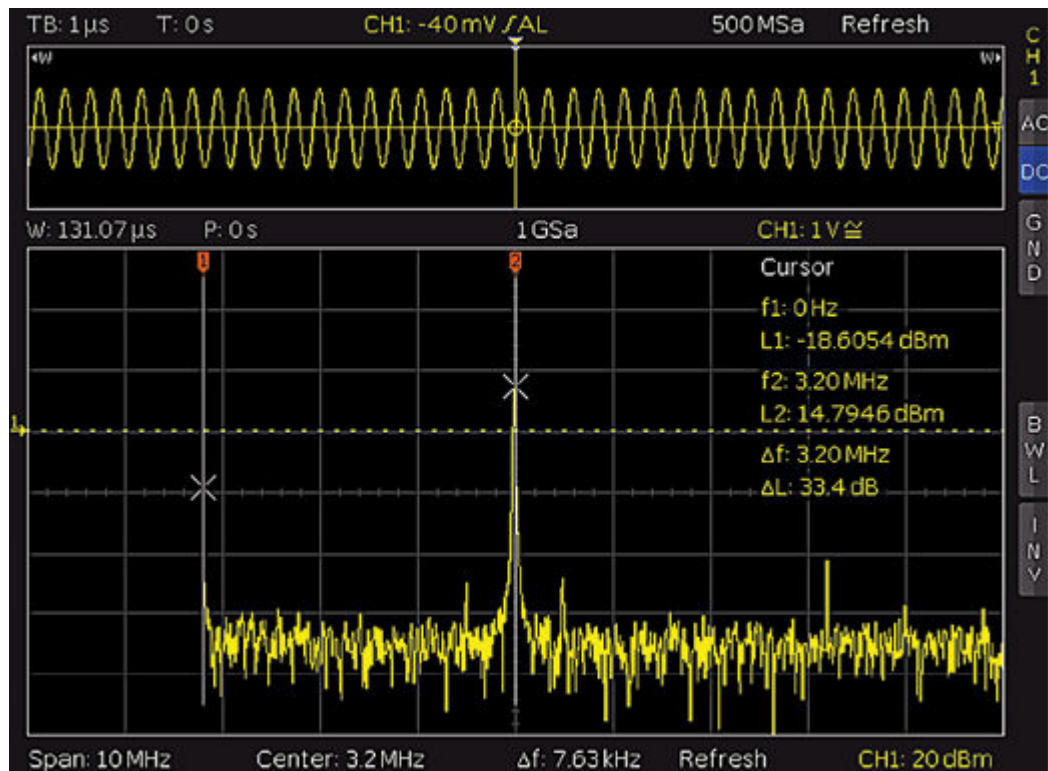

Figure 7-12: FFT

In FFT mode, the screen is divided into two grids:

- The upper grid shows the voltage vs time waveform. The time domain settings are shown above the grid, on the left.
- The area between the upper and the lower grid shows details about zoom and position.
- The lower, large grid shows the frequency domain with the most frequent frequencies in the signal and the corresponding amplitudes.
- The line below the FFT grid indicates the frequency domain settings (span and center).

If the FFT grid is active, it is outlined in white, and the [Scale] knob in the Horizontal section changes the span of the FFT. The span is specified in Hz (Hertz) and identifies the width of the displayed frequency range. The span position is determined by the center value, which is set using the [Position] knob in the Horizontal section. The displayed frequency range is $(\text{Center} - \text{Span}/2)$ to $(\text{Center} + \text{Span}/2)$.

The minimum frequency increment depends on the time base. The greater the time base, the smaller the span. Another important element for the FFT is the setting "Max. Sampling Rate" in the "ACQUIRE" menu.

- ▶ To toggle the settings between time domain, zoom, and frequency domain, press the [Scale] knob in the Horizontal section.

Active settings are highlighted in white, inactive settings are gray.

The FFT menu provides further settings.

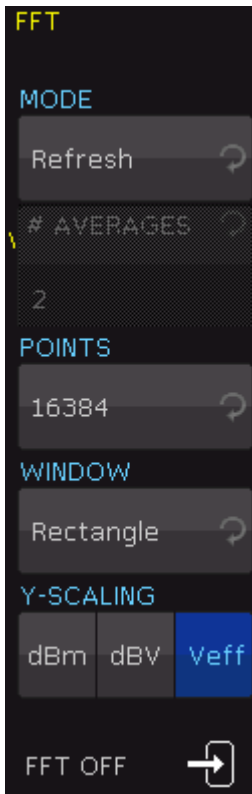

MODE

Sets the display type:

- "REFRESH" Calculates and displays the FFT without additional evaluation or editing of the captured data. The new input data is captured, displayed and overwrites previously stored and displayed values.
- "ENVELOPE" The maximum deflections of all spectra are stored separately in addition to the current spectrum. They are updated with each new spectrum. The maximum values are displayed with the input data and create an envelope curve. The spectrum is located within the envelope limits. The envelope forms an area or a sleeve including all occurrences of FFT signal values. If a signal parameter is changed, the envelope curve is reset.
- "AVERAGE" Calculates the mean value from several spectra to reduce noise. The softkey "AVERAGES" selects the number of spectra used to calculate the mean value.

POINTS

Selects the maximum number of capture points to be included in the calculation. Possible values are 2048, 4096, 8192, 16384, 32768, 65536, 131072 points.

WINDOWS

Sets the window type to improve the FFT display. Various window functions are provided in the R&S RTC1000 to suit different input signals. Each of the window functions has specific characteristics, including some advantages and some trade-offs. Consider these characteristics carefully to find the optimum solution for the measurement task.

- "Hanning" The Hann window is bell shaped. Unlike the Hamming window, its value is zero at the borders of the measuring interval. Thus, the noise level within the spectrum is reduced and the width of the spectral lines enlarges.
Use this window to measure amplitudes of a periodical signal precisely.

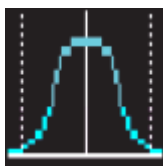

- "Hamming" The Hamming window is bell shaped. Its value is not zero at the borders of the measuring interval. Thus, the noise level inside the spectrum is higher than Hanning or Blackman, but smaller than the rectangular window. The width of the spectral lines is thinner than the other bell-shaped functions.
Use this window to measure amplitudes of a periodical signal precisely.

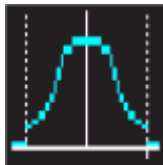

- "Blackman" The Blackman window is bell shaped and has the steepest fall in its wave shape of all other available functions. Its value is zero at both borders of the measuring interval. In the Blackman window, the amplitudes can be measured precisely. However, determining the frequency is more difficult.
Use this window to measure signals with single frequencies to detect harmonics and accurate single-tone measurements.

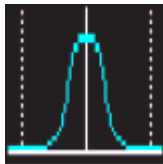

- "Rectangle" The rectangular window multiplies all points by one. The result is a high frequency accuracy with thin spectral lines, but also with increased noise.
Use this function for measurements of separation of two tones with almost equal amplitudes and a small frequency distance.



Y-SCALING

Sets the scale of the amplitude in FFT: logarithmically ("dBm" / "dBV") or linear ("Veff"). The unit dBm (Decibel-Milliwatt) refers to 1 mW. The unit dBV (Decibel-Volt) refers to 1 V_{eff}.

FFT OFF

Deactivates the FFT function. Alternatively, you can press the [FFT] key on the control panel again.

7.6 Pass/Fail Test Based on Masks

The Pass/Fail test evaluates whether a signal is located within defined limits. The limits are set by a mask. If the signal exceeds the mask limits, an error (fail) is counted. The number of errors, the number of successful acquisitions, and the total acquisition count are displayed at the bottom of the display. You can also start certain actions if an error is discovered.

To access the Pass/Fail test menu

1. Press the [UTIL] key in the Vertical section.
2. On menu page 2|2, press "PASS/FAIL".
3. To open the menu, press [UTIL] and "PASS/FAIL" again.

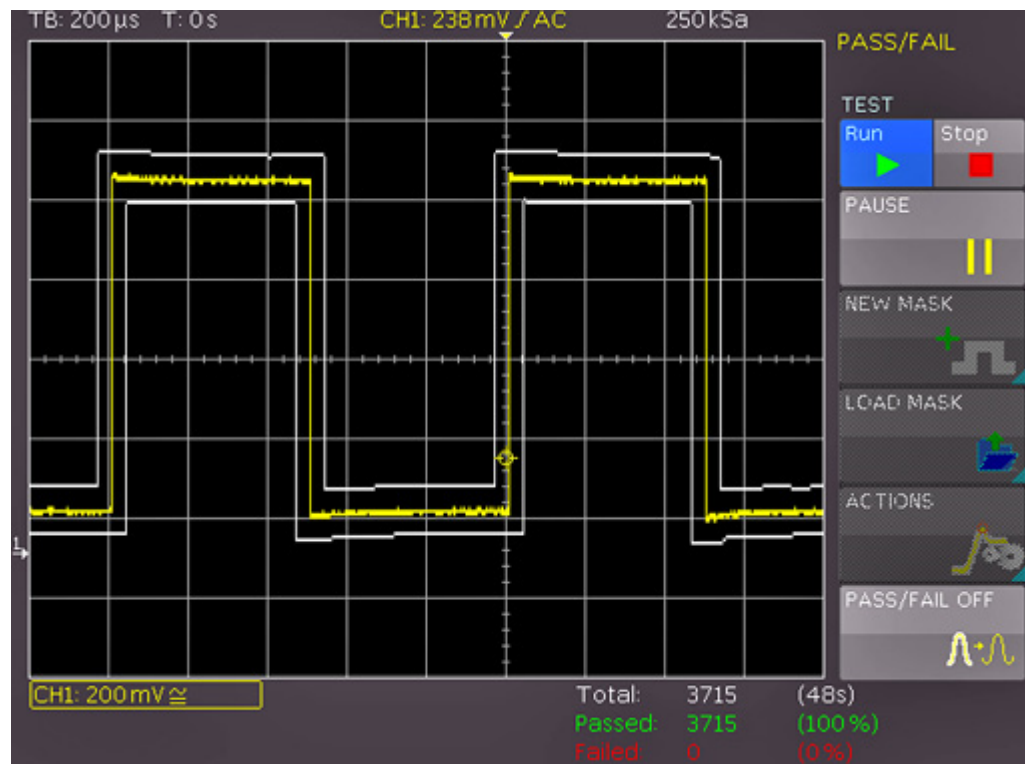

Figure 7-13: PASS/FAIL mask test

Before you can start the mask test, generate or load a mask and select an action.

To generate new mask

1. In the "PASS/FAIL" menu, press "NEW MASK".
2. To copy the current signal into a mask, press "COPY CHANNEL".

The mask is displayed in white and appears as an overlay of the output signal.

3. To shift the mask vertically, or to enlarge it, press "Y-POSITION" and "STRETCH Y", and use the Universal knob
4. To set the tolerance for the mask test, press "WIDTH Y" and "WIDTH X". Use the Universal knob or the [KEYPAD] to enter values with a resolution of 1/100 division.

A mask has a minimum and a maximum value for each captured data value. The minimum and maximum value for a source waveform with only one value per data are identical. The width indicates the distance between the mask points and the original point. The greater the selected value is, the greater are the potential waveform deviations in the amplitude.

The generated and edited mask can be used immediately for the test, however, it is only saved temporarily in the instrument storage.

Masks are displayed as light white waveforms on the screen. If a mask was copied or loaded, you can use the menu to change the limits for the test.

5. To store the mask permanently to a USB flash drive or in the internal memory, press "SAVE".
6. To return to the "PASS/FAIL" menu, press the "Back" key.

To load a mask

1. In the "PASS/FAIL" menu, press "LOAD MASK" to open a file browser which allows you to load previously stored masks for the test).
2. In the file browser, select the mask file (file extension .MSK).
3. Load the selected file.
4. To change a loaded mask, access the "NEW MASK" menu.

A loaded mask is adjusted in the same way as a created mask. You can save the changed mask.

To select an action:

1. In the "PASS/FAIL" menu, press "ACTIONS"
2. Select the actions:
 - Audio signal if the tolerance limits are exceeded
 - Stop at failure, the number of failures is adjustable
 - Pulse at the [Aux Out] output in case of failure
 - Screenshot at first failure, saved on USB flash drive
 - Print on connected printer
 - Waveform data saved to file

An action is performed if the condition is met, for example, a given number of mask failures.

3. To return to the "PASS/FAIL" menu, press the "Back" key.

To perform a pass/fail test

1. In the "PASS/FAIL" menu, press "TEST Run/Stop" to start the test.
Below the grid, you see the total number and the total duration of the tests in white. The number of successful tests and their percentage is displayed in green, and the number of failures and their percentage are displayed in red.
2. To interrupt the test while the acquisition of signals is continued, press "PAUSE".
3. To resume the test and to continue all event counters, press "PAUSE" again.
4. To finish the test, press "TEST Stop".
The event and time counters are stopped.
If you start a new test with "TEST Run", all counters are reset to zero.
5. To deactivate the "PASS/FAIL" mode, press "PASS/FAIL OFF".

7.7 Component Test

The R&S RTC1000 has a built-in component tester.

1. Connect the unit under test to the [Aux Out] connector using a BNC/Banana adapter.



Figure 7-14: BNC/banana adapter connected to [Aux Out]

2. Press the [UTIL] key in the Vertical section.
3. Press "COMP. TEST".

CAUTION

Risk of electric shock

Make sure to discharge capacitors before test.



If components are tested which are located in circuits or instruments, make sure to set the circuits or instruments currentless. If they are operated from the mains, also pull out the mains plug of the test object. Thus, loops between the scope and the test object via the safety earth are avoided, which can cause false results.

In component tester mode, the Y-preamplifiers and the timebase are disconnected. Signals can be present at the inputs as long as the unit under test is not connected to any circuit. It is possible to test components remaining in their circuits, but in such cases all signals must be disconnected from the front panel BNC connectors (see [Chapter 7.7.1, "In-circuit Tests"](#), on page 82).

The test principle is a generator within the R&S RTC1000 which generates a 50 Hz or 200 Hz ($\pm 10\%$) sine wave. The sine wave feeds the series connection of the test object and a sense resistor.

- Is the test object short-circuited, the line is vertical (no voltage, current maximum).
- If the test object is open-circuited or missing, a horizontal line appears (voltage, but no current).
- If the test object has only a real part such as a resistor, both voltages are in phase; the display is a straight line, more or less slanted.

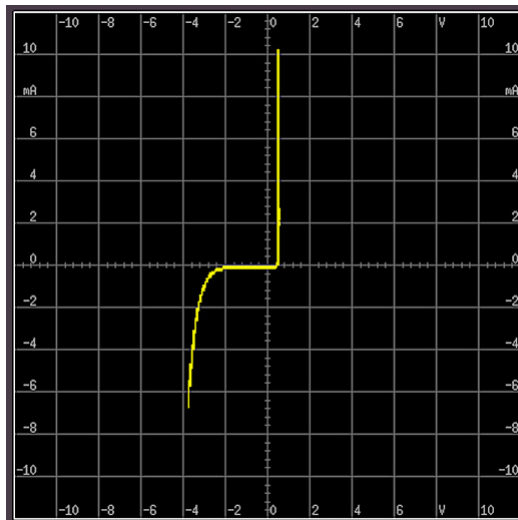

Figure 7-15: Component test example

The angle of the line is a measure of the resistance value. Resistor measurements between Ω and $k\Omega$ are possible. Capacitors can be measured between μF and mF . Capacitors and inductors cause phase shift between voltage and current and hence between the voltages. The phase shift causes displays of ellipses. The location and the

form factor of the ellipse are determined by the apparent impedance at 50 Hz (resp. 200 Hz).

- An ellipse with horizontal long axis indicates a high impedance (small capacitance or large inductance).
- An ellipse with vertical long axis indicates a low impedance (large capacitance or small inductance).
- An ellipse with slanted long axis indicates a relatively large resistive loss in series with the impedance of the capacitor or inductor.

When testing semiconductors, the transition from the non-conducting to the conducting state is indicated in their characteristic. As far as is possible, with the available voltages and currents, the forward and backward characteristics are displayed (e.g. with zener diodes up to 9 V). Because this is a two-pole measurement, the gain of a transistor cannot be determined, however, the B-C, B-E, C-E diodes can be measured. With this exception, the diodes can be measured without fear of destruction as the maximum voltage is limited to 9 V and the current to a few mA. This implies, however, that a measurement of breakdown voltages > 9 V is not possible. This is no disadvantage because, if there is a defect in a circuit, gross deviations are to be expected which point to the defective component. Rather exact results can be achieved if the measurements are compared to those of intact components. This is especially true for semiconductors. The polarity of diodes or transistors can thus be identified if the lettering or marking is missing. Please note that with semiconductors changing the polarity causes the display to rotate 180 degrees around the screen center. More important in practice is the quick determination of plain shorts and opens which are the most common causes of requiring service.

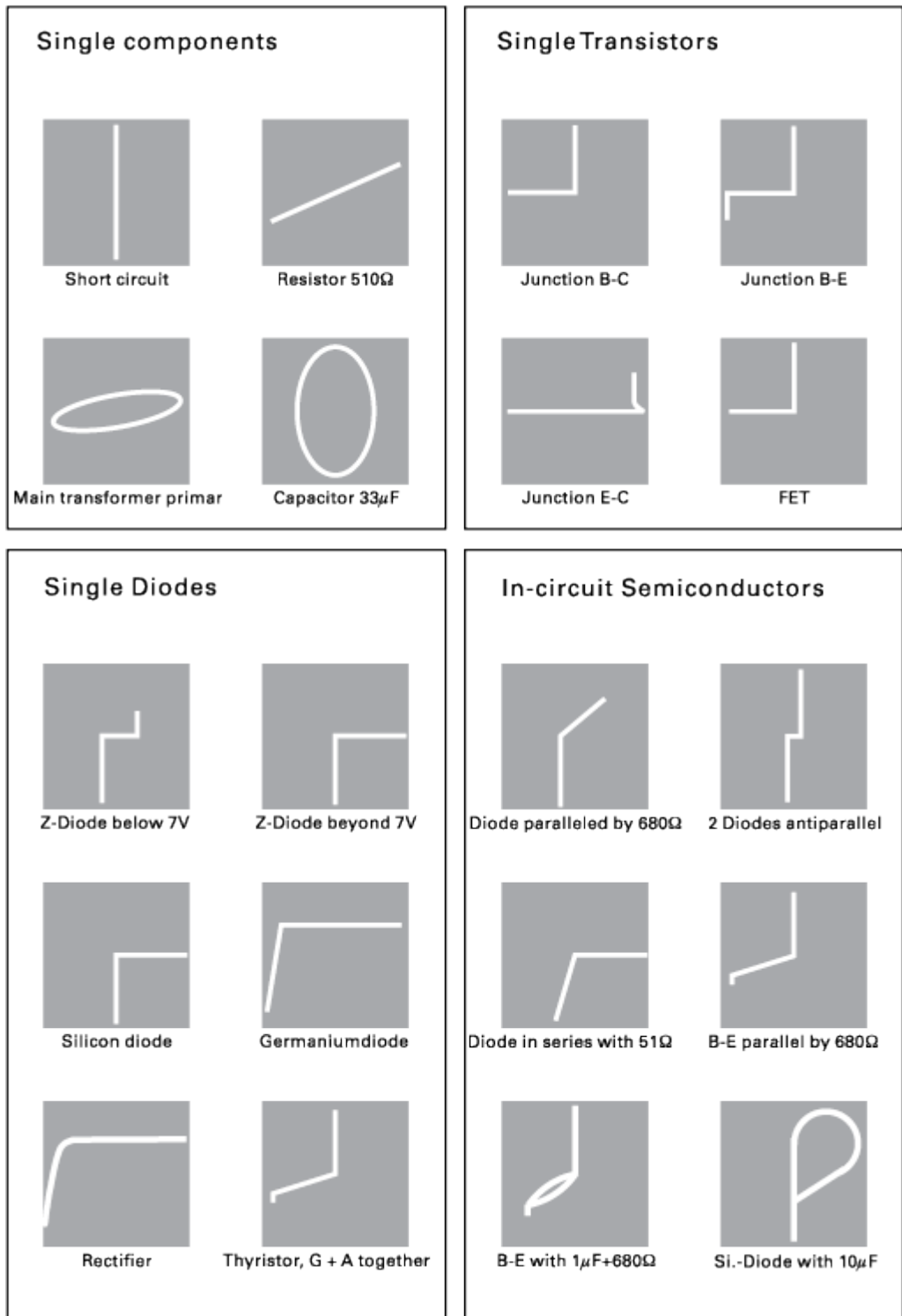

Figure 7-16: Exmaple results of component tests

NOTICE**Risk of instrument damage**

Observe the necessary precautions when handling MOS components. They can be destroyed by static charges or tribo electricity.

7.7.1 In-circuit Tests

In-circuit tests are possible but often do not deliver clear results. By paralleling of real or complex impedances – especially if those are of fairly low impedance at 50 Hz/200 Hz – there are mostly great differences compared to individual components. If circuits of the same type have to be tested often (service), comparisons with intact circuits can help again. This is also quickly done because the intact circuit has not to be functional, also it must not be energized.

To test circuits of the same type

1. Probe the various test points of the unit under test with the cables of the component tester.
2. Probe the various test points of the intact unit with the cables of the component tester.
3. Compare the screen displays.

Sometimes the unit under test can already contain an intact portion of the same type, for example, with stereo circuits, push-pull circuits or symmetrical bridge circuits.

4. In cases of doubt, unsolder one side of the dubious component.

7.8 Digital Voltmeter

The digital voltmeter captures all input data with the selected vertical sensitivity and the basic accuracy of the ADC. The digital voltmeter is independent from the capture settings and the post processing of the transformer values. Measurement values are determined using the measurement interval to ensure the defined frequency range of 20 Hz to 100 kHz. The measurement interval of the digital voltmeter is not the acquisition time interval. Therefore, the measurement values of the digital voltmeter cannot be the same as the measurement values of the AUTO MEASURE values.

1. Press the [UTIL] key in the Vertical section.
2. Press "DIG. VOLTMETER".

The digital voltmeter has a 3-digit voltage display.

3. You can set four configurable measuring displays. For each channel, you can measure and display two values:

- a) Select the primary measurement for channel 1 and channel 2.
- b) Press "SECONDARY" for the corresponding channel to select the secondary measurement.

The following primary and secondary measurements are available:

- OFF: Measurement off
- DC: Mean
- AC+DC RMS: RMS
- AC RMS: Standard deviation

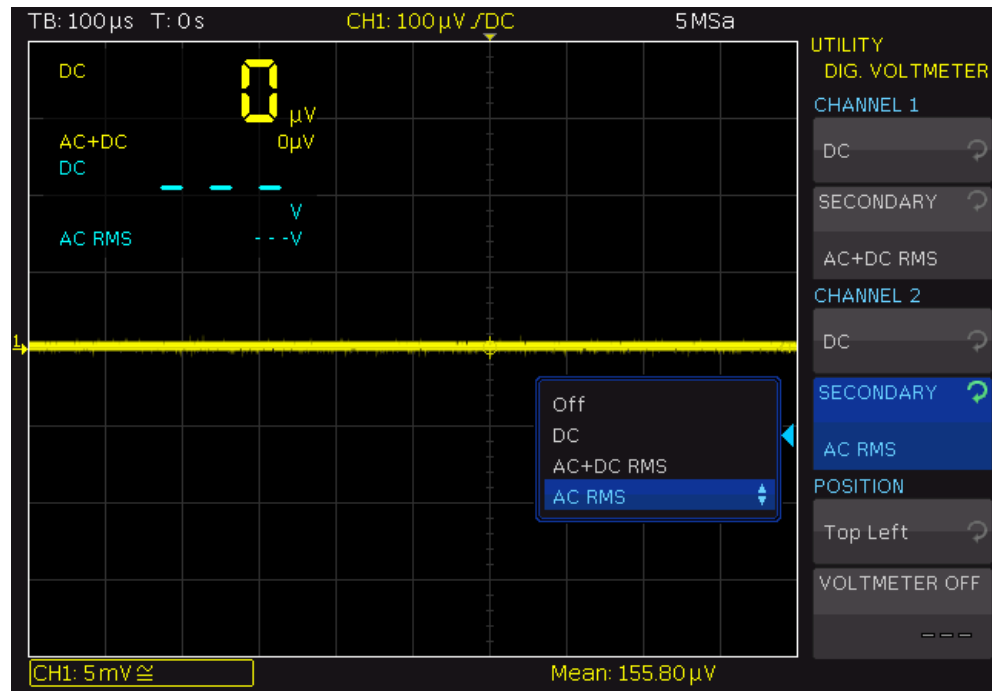

Figure 7-17: Digital voltmeter

The primary measurement is shown in a large font, and the secondary measurement in a small font. All measurements can be configured separately.

4. To define the position of the measurement display, use "POSITION".
Note: When the "XY" mode is active, the display position of the digital voltmeter is predefined and cannot be modified.
5. To deactivate the digital voltmeter function and to close the menu, press "VOLTMETER OFF".

8 Measurements

There are several methods to measure on signals: quick view, cursor measurements and automatic measurements. All measurements are stored in a buffer memory that is larger than the display memory.

8.1 Quick View

The quick view function provides a quick overview of the typical signal characteristics. Measurement results are displayed at the bottom of the screen and with a cursor on the signal.



Only one channel can be active in the Quick View mode. All measurements are performed on the active channel.

1. Press the [QUICK VIEW] key in the Analysis section.

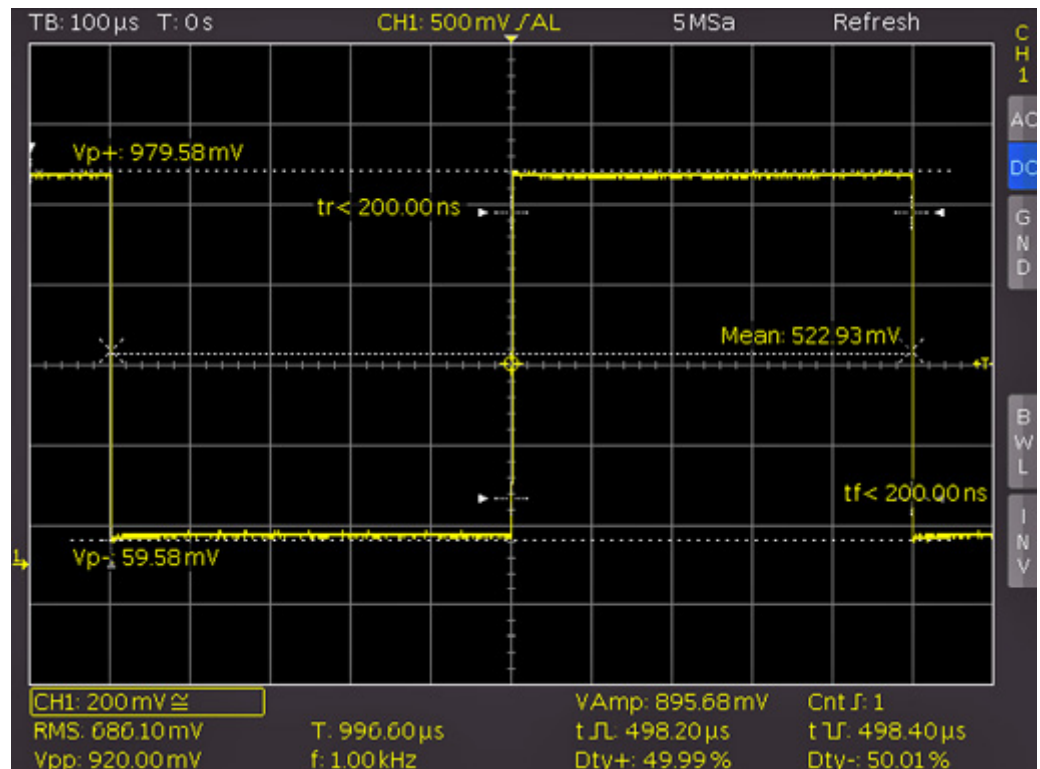

2. The following measurement values are displayed directly in the signal:
 - Maximum voltage (V_{p+})
 - Mean voltage (Mean)
 - Minimum voltage (V_{p-})
 - Rise time (t_r)
 - Fall time (t_f)

The following measurement values are displayed at the bottom of the screen:

- RMS value
- Peak to peak voltage
- Amplitude
- Pos. pulse width
- Pos. duty ratio
- Period
- Frequency
- Number of positive /slopes
- Neg. pulse width
- Neg. duty ratio

3. Press the [QUICK VIEW] key again to switch off the function.

The six measurement parameters on the bottom right can be changed using the [AUTO MEASURE] key, see [Chapter 8.3, "Automatic Measurements"](#), on page 88.

8.2 Cursor Measurements

Cursor measurements are often used with an oscilloscope. Depending on the measurement type, up to three cursor lines are available.

To move cursors:

1. To select the cursor line, press the Universal knob in the Cursor/Menu section.
2. To position the cursor line, turn the Universal knob.

The measurement results are displayed at the bottom of the screen.

If "n/a" is displayed, the measurement is not applicable to the signal. For instance, this can be the case for a voltage measurement on a "POD" because only logic states without voltage reference are displayed.

If "?" is displayed, the display does not show a complete measurement result. For instance, the period to be measured is not completely displayed and cannot be identified.

8.2.1 Cursor Measurement Settings

- ▶ Press the [CURSOR MEASURE] key in the Cursor/Menu section.

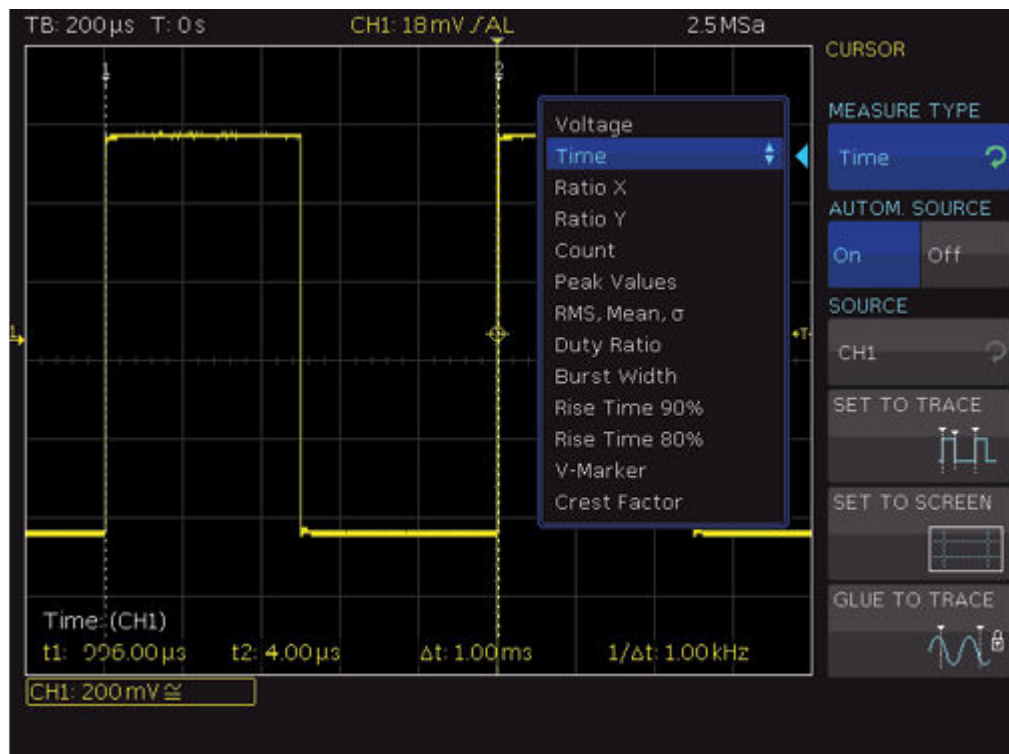

Figure 8-1: Cursor measurement menu

MEASURE TYPE

Defines the measurement type. To learn about the individual types, see [Chapter 8.2.2, "Measurement Types"](#), on page 87.

AUTOM. SOURCE, SOURCE

If "AUTOM. SOURCE" is activated ("On"), the selected channel is used as source for the measurement. If the "AUTOM. SOURCE" is deactivated ("Off"), set the channel with "SOURCE".

SET TO TRACE

Places the cursors in their optimal position on the waveform and allows fast and typically optimal automatic positioning of the cursors. Mostly, only fine-tuning is required. If "SET TO TRACE" does not provide the anticipated results due to complex signals, use the key "SET TO TRACE" to position the cursors in a predefined starting position, and to return distant cursors to the screen.

SET TO SCREEN

Sets the cursors to their default position. Use this function to return distant cursors to the screen.

GLUE TO TRACE

If active, the cursors stay on the selected data point without changing the position in the measurement signal if the scaling is modified (cursors are "glued" to the signal). The measured value remains unmodified.

If deactivated, the cursors stay in position on the screen if the waveform is scaled, and the measured value changes.

8.2.2 Measurement Types

The following cursor measurement types are available:

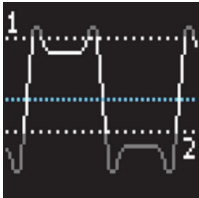

Voltage

"Voltage" provides two cursors and measures three voltages. The values V1 and V2 correspond to the voltage between the zero base line of the selected signal and the current position of the first or second cursor. The value ΔV is voltage difference between the two cursors.

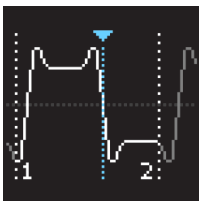

Time

"Time" provides two cursors and measures three times and an equivalent frequency. The values t1 and t2 correspond to the time between the trigger and the current position of the first or second cursor. The value Δt corresponds to the time between the two cursors.

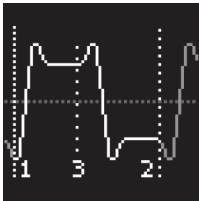

Ratio X

"Ratio X" provides three cursors and measures a ratio in X direction (e.g. a duty ratio) between the first two cursors and the first and the third cursor. The measurement values are displayed in four formats (floating point, percent, degrees and radians).

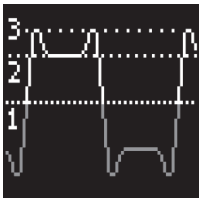

Ratio Y

"Ratio Y" provides three cursors and measures a ratio in Y direction (e.g. an overshoot) between the first two cursors and the first and the third cursor. The measurement values are displayed in two formats (floating point and percent).

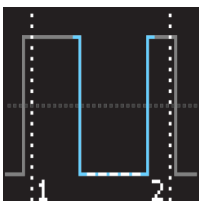

Count

"Count" provides three cursors to count signal changes that exceed the threshold within a specific interval. The interval is set by the first two cursors and the threshold is the third cursor. The measurement values are displayed in four formats (number of rising and falling slopes and number of positive and negative pulses).

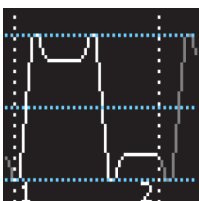

Peak Values

"Peak Values" provides two cursors and measures the minimum and the maximum voltage of a signal within the interval that is set by both cursors. The values Vp- and Vp+ correspond to the minimum and the maximum voltage. The peak value (Vpp) corresponds to the voltage difference between the minimum and maximum value.

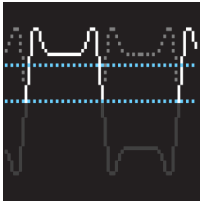
**RMS, Mean, σ**

This measurement type provides two cursors and measures the effective value (RMS – root mean square), the mean value and the standard deviation within the interval set by both cursors.

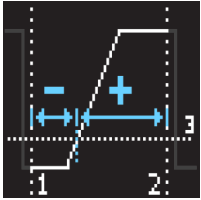
**Duty Ratio**

"Duty Ratio" provides three cursors to determine the duty ratio between the two horizontal cursors. The third cursor specifies the threshold at which the duty ratio is measured.

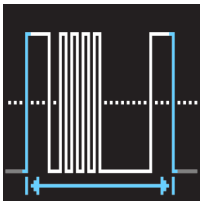
**Burst Width**

"Burst Width" determines the duration of a burst from the first edge to the last edge (Bst).

Freq. & Period

"Freq. & Period" provides three cursors and measures the frequency and the period.

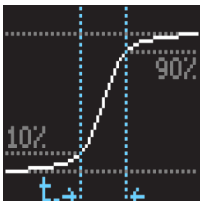
**Rise Time 90%, Rise Time 80%**

These measurement types provide two cursors and measure the rise and fall time of the first rising slope in the display within the time span set by the cursors. The rise time identifies the time in which the signal rises or falls from 10% to 90% of its amplitude, or from 20% to 80%.

**V-Marker**

"V-Marker" provides two cursors and measures three voltages and a time. The values V1 and V2 correspond to the voltage between the zero base line of the selected curve and the current position of the first or second cursor. The value ΔV corresponds to the voltage difference between the two cursors. The value Δt corresponds to the time between the two cursors.

Crest Factor

The crest factor (peak-to-average ratio) is calculated from the maximum value divided by the RMS value of the waveform (Crest).

8.3 Automatic Measurements

The R&S RTC1000 also features various automatic measurements. Up to 6 measurements can run in parallel.

The results of automatic measurements are displayed at the bottom of the screen. The results of the automatic measurements are also shown in the quick view, they are the 6 results on the right.

If "n/a" is displayed, the measurement is not applicable to the signal. For instance, if you measure a voltage on a POD, no result is displayed because only logic states without voltage reference are displayed.

If "?" is displayed, the display does not show a complete measurement result. For instance, the period to be measured is not completely displayed and cannot be identified.

8.3.1 Settings for Automatic Measurements

- Press the [AUTO MEASURE] key in the Analysis section.

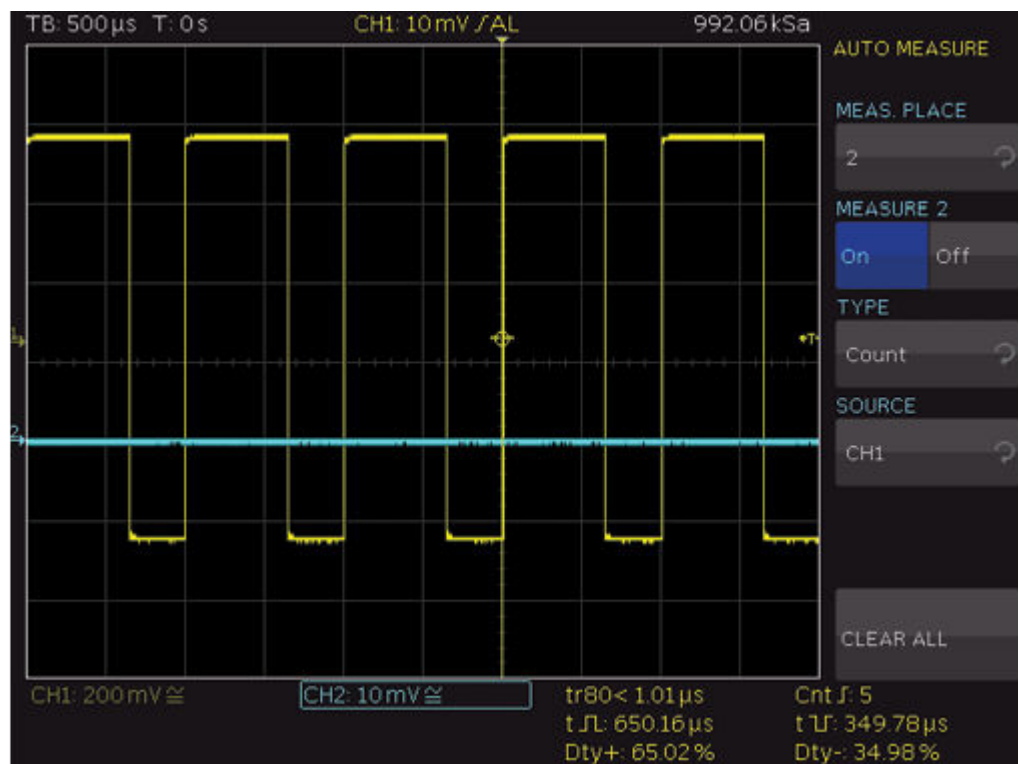

Figure 8-2: Auto measurement settings and results

MEAS. PLACE

Selects the measurement place. To each measurement place, an automatic measurement function is assigned.

MEASURE

Switches the selected measurement place on or off.

TYPE

Defines the measurement type. To learn about the types, see [Chapter 8.3.2, "Automatic Measurement Types"](#), on page 90).

SOURCE

Selects the waveform to be measured. The list only includes displayed channels. Possible sources are analog, digital and mathematical channels.

CLEAR ALL

Switches off the activated automatic measurements.

8.3.2 Automatic Measurement Types

The following types of automatic measurements are available:

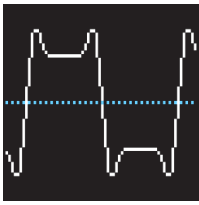
**Mean Value**

Measures the mean value of the signal amplitude (Mean). If the signal is periodic, the first period on the left of the screen is used for the measurement.

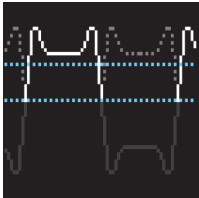
**RMS Value**

"RMS Value" measures the effective value of the displayed signal. If the signal is periodic, the first period on the left of the screen is used for the measurement. The effective value is not based on a sine signal but is calculated directly (TrueRMS).

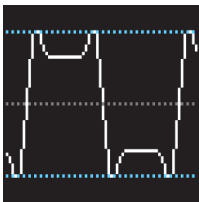
**Peak Peak**

"Peak Peak" measures the voltage difference between the maximum and the minimum peak value of the displayed signal (V_{pp}).

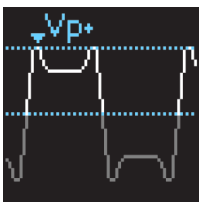
**Peak +**

"Peak +" measures the maximum voltage value in the display (V_{p+}).

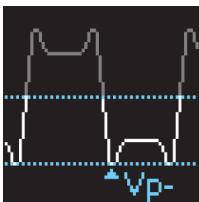
**Peak -**

"Peak -" measures the minimum voltage value in the display (V_{p-}).

**Frequency**

Measures the frequency of the signal from the reciprocal value of the first signal period T (f).

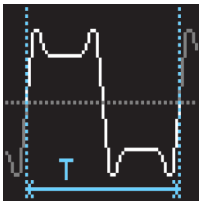
**Period**

"Period" measures the duration of the signal period T . The period identifies the duration between two equal values of one periodically repeated signal.

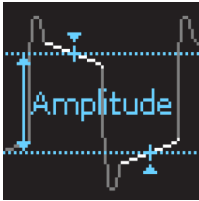
**Amplitude**

Measures the amplitude of a square wave signal (V_{Amp}). The measurement calculates the difference in voltage between the upper and the lower level (V_{base} and V_{top}). The measurement requires at least one complete period of a triggered signal.

Crest Factor

The crest factor (peak-to-average ratio) is calculated from the maximum value divided by the RMS value of the waveform (Crest).

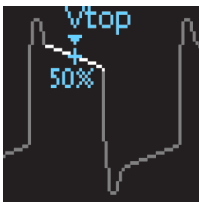
**Top Level**

"Top Level" measures the mean voltage level of an upper square wave (V_{Top}). The measurement calculates the mean value of the roof slope without overshoot. The measurement requires at least one complete period of a triggered signal.

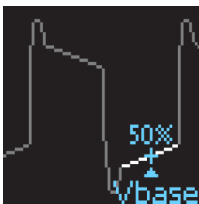
**Base Level**

"Base Level" measures the mean voltage level of the lower square wave (V_{Base}). The measurement calculates the mean value of the roof slope (without overshoot). The measurement requires at least one complete period of a triggered signal.

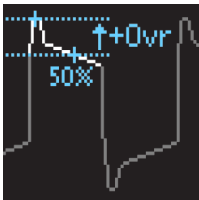
**Pos. Overshoot**

"Pos. Overshoot" measures the positive overshoot of a square wave which is calculated from top level, peak + and amplitude value (+Ovr).

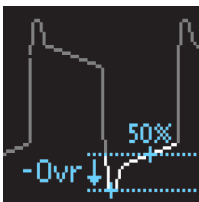
**Neg. Overshoot**

"Neg. Overshoot" measures the negative overshoot of a square wave which is calculated from base level, peak - and amplitude value (-Ovr).

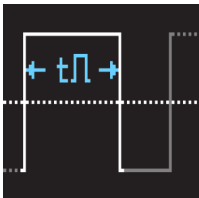
**Pulse Width +**

"Pulse Width +" measures the width of the positive pulse. A positive pulse consists of a rising slope followed by a falling slope. The measurement identifies the two slopes and calculates the pulse width from their time difference. The measurement requires at least one complete period of a triggered signal.

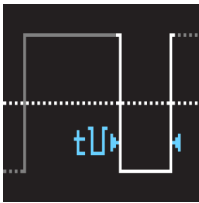
**Pulse Width –**

"Pulse Width –" measures the width of the negative pulse. A negative pulse consists of a falling slope followed by a rising slope. The measurement identifies the two slopes and calculates the pulse width from their time difference (t). The measurement requires at least one complete period of a triggered signal.

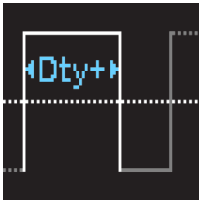
**Duty Cycle +**

"Duty Cycle +" measures the positive duty ratio. Positive signal portions are identified over a period and set in relation to the signal period. The measurement requires at least one complete period of a triggered signal. The measured value Dty_+ is displayed as a percentage of the signal period.

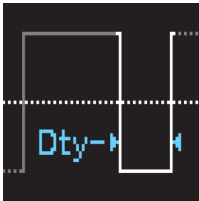
**Duty Cycle –**

"Duty Cycle –" measures the negative duty ratio. Negative signal portions are identified over a period and set in relation to the signal period. The measurement requires at least one complete period of a triggered signal. The measured value Dty_+ is displayed as a percentage of the signal period.

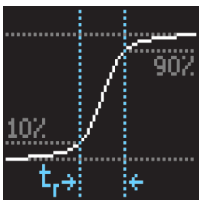
**Rise Time 90%, Rise Time 80%**

Measures the rise time of the first rising slope in the display (t_r , t_{r80}). The rise time is the time in which the signal rises from 10% to 90% or from 20% to 80% of its amplitude.

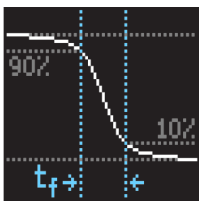
**Fall Time 90%, Fall Time 80%**

Measures the fall time of the first falling slope in the display (t_f , t_{f80}). The fall time is the time in which the signal falls from 90% to 10% or from 80% to 20% of its amplitude.

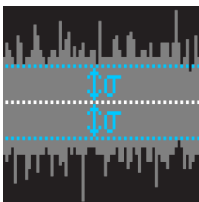
 **σ -Std. Deviation**

Measures the standard deviation of the signal amplitude in the display. The standard deviation is deviation of a signal from its mean value. A low result indicates that the values are close to the mean value. A higher result illustrates that the difference between the values is greater.

**Delay**

"Delay" measures the time delay between the measurement source and the reference source. The instrument searches for the slope of the measurement source that is closest to the time reference. Then, beginning from this point, it searches for the nearest slope of the reference source. This time difference is the measurement result. Press "DELAY SETUP" to select measurement source, reference source and slopes.

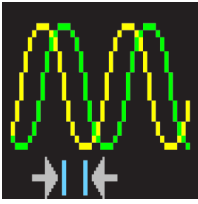
**Phase**

Measures the phase between two slopes of two channels in the display (Phs). It measures the relation of the time delay between the sources to the signal period of the measurement source. The instrument searches for the slope of the measurement source that is closest to the time reference. Then, beginning from this point, it searches for the nearest slope of the reference source. The time difference and the signal period indicate the measurement result in degrees. Select the "MEAS. SOURCE" and the "REF. SOURCE".

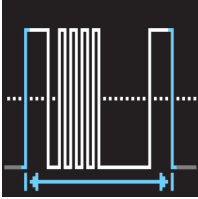
**Burst Width**

Measures the duration of burst from the first edge to the last edge (Bst).

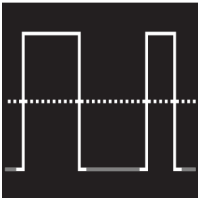
**Count P+**

"Count P+" counts positive pulses in the display. A negative pulse consists of a falling slope followed by a rising slope. The mean value is calculated from the amplitude of the measurement signal. A slope is counted if the signal crosses the mean value. A pulse that passes the mean value only once is not calculated..

**Count P-**

"Count P-" counts negative pulses in the display. A negative pulse consists of a falling slope followed by a rising slope. The mean value is calculated from the amplitude of the measurement signal. A slope is counted if the signal crosses the mean value. A pulse that passes the mean value only once is not calculated.

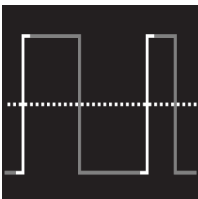
**Count S+**

"Count S+" counts signal changes (slopes) from low level to high level in the display. The mean value is calculated from the amplitude of the measurement signal. A slope is counted if the signal crosses the mean value.

**Count S-**

"Count S-" counts signal changes (slopes) from high level to low level in the display. The mean value is calculated from the amplitude of the measurement signal. A slope is counted if the signal crosses the mean value.

**Trigger Freq.**

"Trigger Freq." measures the frequency of the trigger signal f_{Tr} based on the period duration. The source for the measurement is the current trigger source. The frequency is determined with a hardware counter with high accuracy of 5 digits.

**Trigger Period**

"Trigger Period" measures the duration of periods of the trigger signal T_{Tr} with a hardware counter. The source for the measurement is the current trigger source.

9 Documenting Results

The R&S RTC1000 can store various data to files for further usage, analysis and reporting.

Waveform data and screenshots, which are intended for analysis outside the oscilloscope, are always saved to a USB flash drive. The USB flash drive is the external storage location (FRONT USB). This location is only available if the USB flash drive is connected.

Reference waveforms and instrument settings, which are intended for further use on the instrument, are usually saved to the internal storage (/INT). You can also store them to the external storage, or move them to the other location using the export and import function.



The supported file system in all storage locations is FAT (FAT16/32). Prefer to use USB flash drive up to 4 GB.

- ▶ To save and load data, press the [SAVE/RECALL] key in the General section.

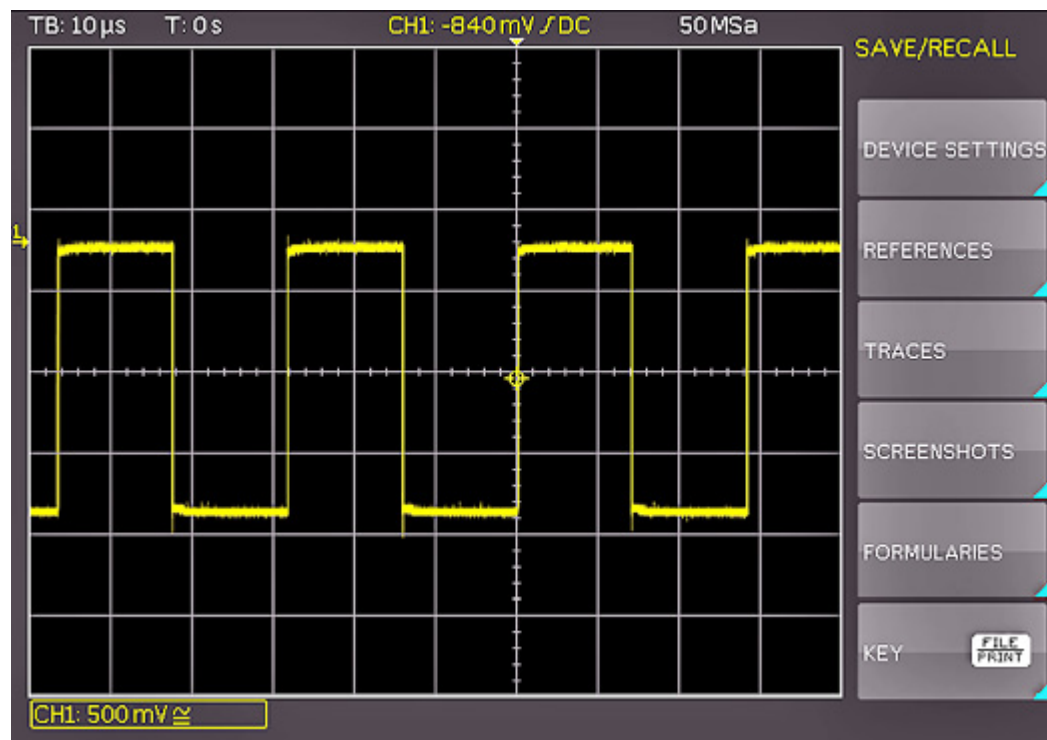

9.1 Saving and Loading Instrument Settings

To repeat measurements or tests at different times or perform similar measurements with different test data, you can save the used configuration settings. Furthermore, it

can be helpful to refer to the configuration settings of a particular measurement when analyzing the results. Therefore, you can easily save the complete measurement configuration.

The softkey "DEVICE SETTINGS" allows you to save current instrument settings, load saved settings and import or export instrument settings to USB flash drive.

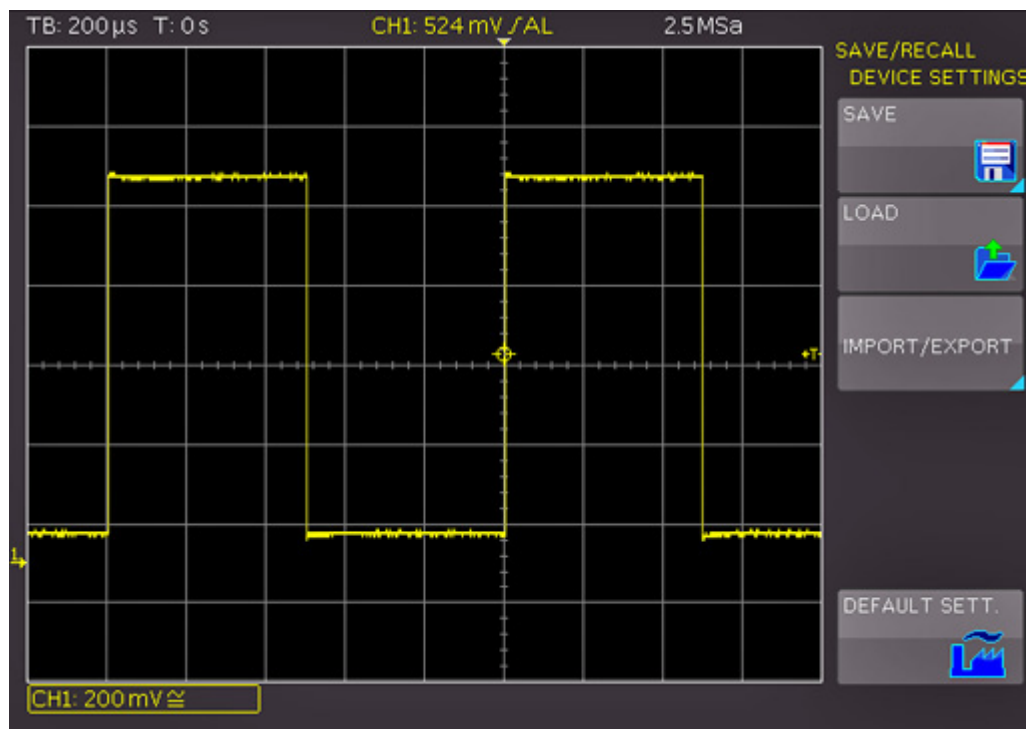

Figure 9-1: SAVE/RECALL menu for instrument settings

To save current instrument settings

1. In the "SAVE/RECALL" > "DEVICE SETTINGS" menu, press the softkey "SAVE" to open the "Save" menu.

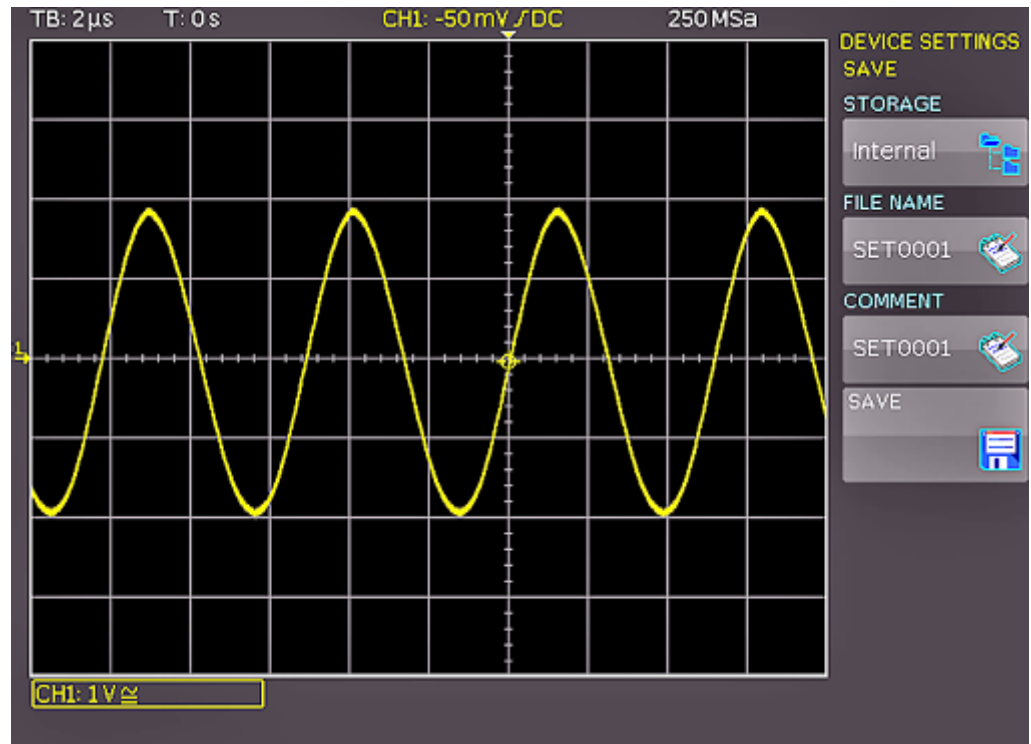

Figure 9-2: SAVE menu for instrument settings

2. Press the "STORAGE" softkey.
The file manager window opens.
3. Select the location: internal memory or front USB connection, where you want to save the instrument settings.
On a USB flash drive, you can also create, change and delete directories.
4. Press "ACCEPT DIR."
5. Press "FILE NAME". Change the file name if necessary. "SET01" is the default name.
6. To enter an optional comment, press "COMMENT".
The comment is displayed in the file manager footer if the file is selected.
7. Select the file format: "SET" or "SCP".
Device settings of an older firmware version in SCP format can be loaded with a newer firmware version.
8. Press "SAVE" to store the settings.

To reload stored settings

1. In the "SAVE/RECALL" > "DEVICE SETTINGS" menu, press the "LOAD" softkey.
2. Press "STORAGE".

3. Use the softkey "SORT ENTRIES" to sort the settings files by name, type, size or date.
4. Use the [Universal] knob to select the settings file.
5. Press "LOAD".
The settings are read and applied on the instrument.
6. To remove files that are no longer required:
 - a) Use the [Universal] knob to select the settings file.
 - b) Press "REMOVE FILE".

To import or export instrument settings

You can copy data between the instrument's internal storage "/INT/ SETTINGS" and a USB flash drive. Make sure that the USB flash drive is connected.

1. In the "SAVE/RECALL" > "DEVICE SETTINGS" menu, press "IMPORT/EXPORT".
2. Press "SOURCE FILE" and select a source file using the [Universal] knob.
3. Press "DEST. PATH" and select a storage location using the [Universal] knob.
4. To change the file name, press "DEST. NAME".
5. Press "IMPORT/EXPORT" to copy the selected settings file.

To restore default instrument settings

- ▶ In the "SAVE/RECALL" > "DEVICE SETTINGS" menu, press "DEFAULT SETT."

9.2 Reference Waveforms

References or reference waveforms are data sets that consist of settings information and waveform data sampled by the A/D converter. References can be stored and reloaded in internal or external storage. You can reload the data into one of the 4 reference memories RE1 to RE4, and display the references. All information (e.g. vertical gain, time base setting, A/D converter data) is included when saving or reloading, enabling a comparison between the original signal and its corresponding values.

To save and load references, a specific reference menu is available. If you want to copy data between the instrument's internal storage and a USB flash drive, use the "SAVE/RECALL" > "REFERENCES" menu.

To create, store and load references

1. Press the [REF] key in the Vertical section.
2. Press the [MENU] key in the Vertical section.

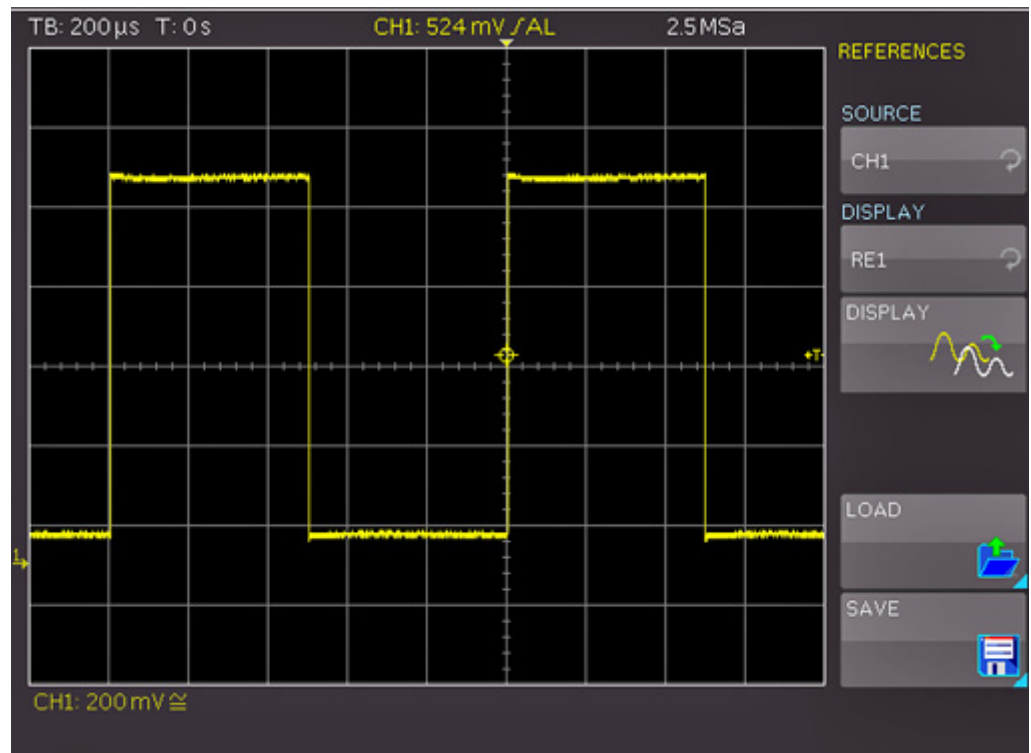

Figure 9-3: Menu for references

3. To create and display a reference waveform:
 - a) Press "SOURCE". Use the [Universal] knob to select the waveform that you want to store as reference.
You can select from active channels, other reference waveforms, pod and mathematical waveforms.
 - b) Press the upper "DISPLAY" softkey. Select one of the references "RE1" to "RE4".
 - c) Press the lower "DISPLAY" softkey.

The data is written to the reference storage, and the reference waveform is displayed.
4. To save a reference:
 - a) Press "SAVE".
 - b) Press "TRACE". Select the waveform that you want to save as reference waveform.
 - c) Select the "STORAGE": internal or USB flash drive.
 - d) Enter the "FILE NAME".
 - e) Press "SAVE".

The reference file is saved in TRF format.
5. To load a reference from a USB flash drive or the internal memory:
 - a) In the "REFERENCES" menu, press "LOAD".

- b) Press "DISPLAY". Use the [Universal] knob to select the target reference waveform.
- c) Press "LOAD".
- d) In the file manager menu, select the storage, the directory, and the file.
- e) Press "LOAD" to read and display the reference.

To import or export references

1. In the "SAVE/RECALL" menu, press "REFERENCES".
2. Press "SOURCE FILE" to select the source file using the [Universal] knob.
3. Press "DEST. PATH" to set the storage location using the [Universal] knob.
4. To change the file name, press "DEST. NAME". Enter the file name.
5. To change the file format, press "DEST. FORMAT".
6. Select the target format. See also [Chapter 9.3.1, "Waveform File Formats"](#), on page 102.
7. Press "IMPORT/EXPORT".

9.3 Waveforms (Traces)

You can store also waveform data without settings to external storage for analysis. Depending on the selected timebase and the record mode in the "ACQUIRE" menu (AUTOMATIC, MAX. SAMPLE RATE or MAX. WAVEFORM RATE), the maximum read-out measurement points varies. To read out the full memory, save the waveform in stop mode with the maximum sampling rate setting.

To store waveform data to file

1. Connect a USB flash drive.
2. In the "SAVE/RECALL" menu, press "TRACES".

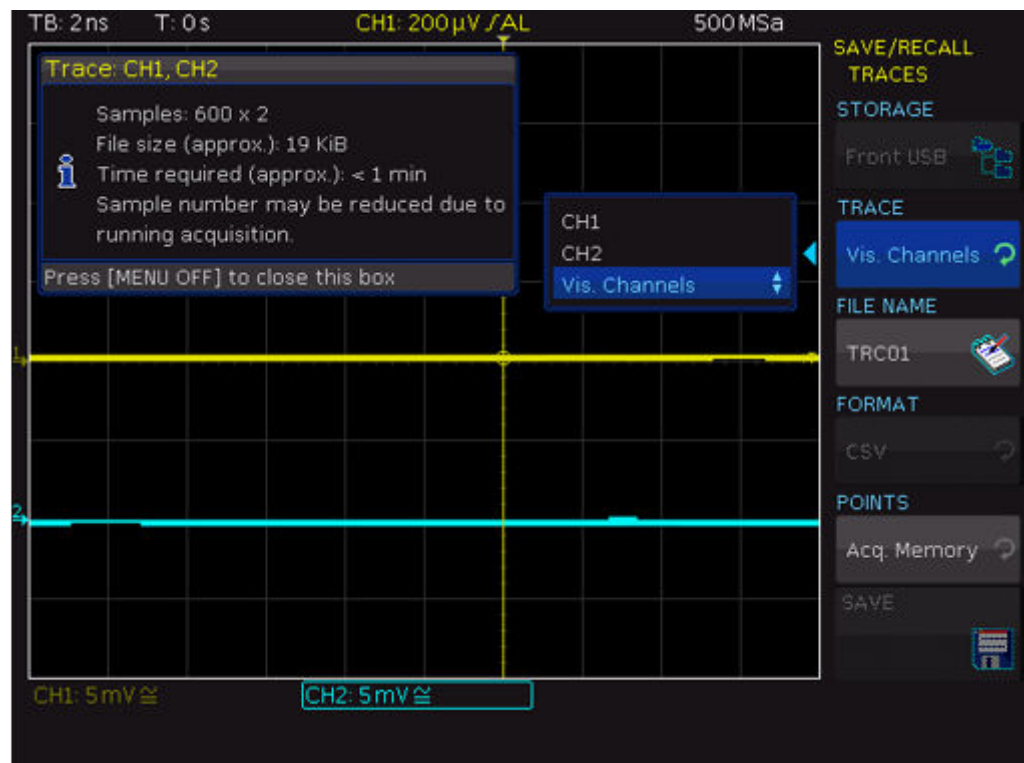

Figure 9-4: Trace storage menu

3. To select the target directory, press "STORAGE".
 - a) Use the softkey "SORT ENTRIES" to sort the files by name, type, size or date.
 - b) Change, create or delete directories.
 - c) Select the target directory.
 - d) Press "ACCEPT DIR." to confirm the target directory and you return automatically to the curve main menu.
4. Press "TRACE". Use the [universal] knob to select the channel, math waveform, reference, or pod.
You can select only active waveforms. You can also save all visible channels to one file.
5. Press "FILE NAME". Enter the file name.
6. Press "FORMAT". Select the target format, see [Chapter 9.3.1, "Waveform File Formats"](#), on page 102.
Note: If "Max. Sampling Rate" is set in the "ACQUIRE" menu, two rows are affixed with a time stamp during the CSV export because a minimum and a maximum value must be assigned to this time value. To acquire an amplitude value per time stamp, activate "Automatic" in the "ACQUIRE" menu.
7. Press "POINTS". Select whether you want to read out the display memory ("Display Data") or the entire acquisition memory ("Acq. Memory").
8. Press "SAVE".

The file is written according to the settings.

9.3.1 Waveform File Formats

Data of all waveforms is saved as a succession of values or pairs of values. Pairs of values are written as two consecutive single values. Depending on the file format, only amplitude values are stored, or the amplitude values are stored together with their time value, or frequency value in FFT mode.



To reload waveform data as a reference waveform, it must be stored in format TRF (save reference) or CSV (save waveform).

9.3.1.1 CSV Format

In a Comma Separated Values text file, the waveform is stored in a two-columned table. Columns are separated by a comma, and the lines are separated by line breaks `\r\n` (0x0D 0x0A). Values are listed in scientific notation.

The first column contains the time values of the samples in relation to the trigger point, and the second column contains the associated amplitude values. The first line indicates the units of the values in each column, and the name of the waveform. Pairs of values are listed as two single values with the same time value (minimum and maximum).

The data can be loaded back to the instrument for further use.

Example CSV1: Waveform of channel 1, single values

```
in s,CH1 in V
-1.1996E-02,1.000E-02
-1.1992E-02,1.000E-02
-1.1988E-02,1.000E-02
-1.1984E-02,1.000E-02
```

Example CSV2: Waveform of channel 1, pairs of values

```
in s,CH1 in V
-2.9980E+00,2.000E-05
-2.9980E+00,1.400E-04
-2.9960E+00,-1.800E-04
-2.9960E+00,1.400E-04
-2.9940E+00,-1.800E-04
-2.9940E+00,1.400E-04
```

Example CSV3: FFT

```
in Hz,FFT in dBm
0.000000E+00,1.03746E+01
1.525879E+02,7.49460E+00
3.051758E+02,-1.19854E+01
4.577637E+02,-1.56854E+01
```

Import of CSV files: If you import a CSV file as reference waveform from a USB flash drive to the instrument, the import converts the data to TRF format. The instrument reads the first and the last time value and calculates the total time of the waveform, and it counts the number of values. Then all amplitude values are read one by one and written with an equidistant time distribution to the TRF file. If the first two time values are identical, the waveform is considered to consist of pairs of values.

9.3.1.2 TXT Format

TXT files are ASCII files that contain only amplitude values but no time values. Amplitude values are separated by commas. Pairs of values are listed as two subsequent single values, without any identification. Amplitude values are given in scientific notation. There is no comma at the end of the file.

Amplitude values are given in scientific notation.

Example: TXT file

```
1.000E-02,1.000E-02,1.000E-02,1.000E-02,3.000E-02
```

9.3.1.3 BIN Format

BIN files contain only binary amplitude values but no time values. Each value has a word size of 8, or 16, or 32 bit, the word size is the same throughout the file.

You can set the word order: BIN MSBF saves data in Big Endian order - beginning with the MSB (Most Significant Byte) and ending with the LSB (Least Significant Byte). BIN LSBF saves data beginning with the LSB and ending with the MSB. Pairs of values are listed as two subsequent single values, without any identification.

9.3.1.4 FLT Format

FLT files contain amplitude values in float format, where a 32-bit float value is saved in 4 successive bytes.

You can set the word order: FLT MSBF saves data in big endian order - beginning with the MSB (most significant byte) and ending with the LSB (least significant byte). FLT LSBF saves data beginning with the LSB and ending with the MSB.

9.3.1.5 TRF Format

TRF is the specific binary format for reference waveforms of the R&S RTC1000. It contains the amplitude value of each sample that is displayed on the screen (8 bit or 16 bit long). For peak-detect waveforms, 2 values per sample are saved. The file contains also time information (time of the first sample and the sample interval) and current instrument settings.

The data can be loaded as reference waveform for further use on the instrument. It is not intended for analysis outside the R&S RTC1000.

9.4 Screenshots

You can create a screenshot of the current display of your waveforms and measurement results and save it to a file, or print it on a connected printer. To optimize the output, you can configure different color modes and formats.



Press the [RUN/STOP] key to stop acquisition before printing to get a correct printout.

9.4.1 Saving Screenshots

You can create a screenshot of the current display of your waveforms and measurement results and save it to a file. Before you can save the screenshot, you have to configure the storage location and file format.

1. Connect a USB flash drive.
2. In the "SAVE/RECALL" menu, press "SCREENSHOTS".
3. Press "STORAGE". Select the target directory for the file. Screenshots are always saved to USB flash drive ("FRONT").
 - a) To sort several settings files by name, type, size or date, use "SORT ENTRIES".
 - b) To open a selected directory, press "CHANGE DIR". You can also create and delete directories.
 - c) Press "ACCEPT DIR." to confirm the target directory.
4. Press "FILE NAME". Use the [Universal] knob or the [KEYPAD] key to enter a name.
5. Press "FORMAT" to select the file format, see ["FORMAT"](#) on page 104.
6. Press "COLOR MODE". Use the Universal knob to select the color mode, see ["COLOR MODE"](#) on page 105.
7. Press "SAVE" to save the current screen to the selected storage location with the selected name and format.

FORMAT

Selects the file format. The file format determines the color depth and the type of compression.

"BMP"	Windows Bitmap Format is an uncompressed format, files are large and saving can take some time.
"GIF"	Graphics Interchange Format
"PNG"	Portable Network Graphic is a graphic format with lossless data compression.

COLOR MODE

Selects the color settings for the screenshot.

"Grayscale"	Colors are converted to gray scales when the waveform is stored.
"Color"	The waveform is stored as it is displayed.
"Inverted (BG)"	The waveform is stored in color with an inverted background.
"Inverted (BG, gray)"	The waveform is stored in gray with an inverted background.
"Inverted (all)"	The waveform and background are stored inverted.
"Inverted (all, gray)"	The waveform and background are stored in gray.

SAVE

Saves a screenshot immediately according to the settings in the "SCREENSHOTS" menu.

PRINT

Prints a screenshot immediately to a connected printer. The function is only available if a printer is connected to the rear USB port and identified by the instrument.

See also: [Chapter 9.4.2, "Printing Screenshots"](#), on page 105.

9.4.2 Printing Screenshots

You can create a screenshot of the current display of your waveforms and measurement results and print it on a printer. To optimize the output, you can configure different color modes. Connect the printer to the rear USB Type B port. Alternatively, you can save screenshots to files, see also: [Chapter 9.4.1, "Saving Screenshots"](#), on page 104.

If you want to print many screenshots, you can assign the printout function to the [FILE/PRINT] key. This key is a shortcut key that initiates the assigned action at a single keypress. Infrequent printouts can be started from the "SAVE/RECALL" menu.

To configure the printer output

1. Connect the printer to the USB port on the rear panel of the instrument.
2. Press [SETUP] > "PAGE 3|3" > "PRINTER".

If the instrument can identify the printer and its supported languages, the "Printer information" window shows a message:



```

Printer
Model: HEWLETT-PACKARD HP LASERJET 2420
Command set: PJL,MLC,PCLXL,PCL,PJL,POSTSCRIPT
This printer is supported.
  
```

Figure 9-5: Supported printer example

3. Press "PAPER FORMAT". Select the required format using the [Universal] knob.
4. Press "COLOR MODE".

5. Select the colors, see ["COLOR MODE"](#) on page 105.
6. To select the printer language that is used by your printer, press "COMMAND SET".

The following printer languages are supported:

- PCL-5
- PCL-XL (= PCL-6)
- Postscript

To start the printout

Infrequent printouts can be started from the "File" menu.

1. Make sure that the printer is configured correctly.
See: ["To configure the printer output"](#) on page 105.
2. Press the [SAVE/RECALL] key.
3. Press "SCREENSHOTS" > "PRINT".

To use quick print with the [FILE/PRINT] key

If you assign the print function to the [FILE/PRINT] key, a screenshot is printed on the connected printer when you press the [FILE/PRINT] key.

1. Configure the [FILE/PRINT] key:
 - a) Press [SAVE/RECALL] > "KEY".
 - b) Press "SCREENSHOTS".
2. Make sure that the printer is configured correctly.
See: ["To configure the printer output"](#) on page 105
3. Press the [FILE/PRINT] key.

9.5 Quick Access with FILE/PRINT Key

The [FILE/PRINT] key is a shortcut key that initiates the associated action. With this key, it is easy to print screenshots to a connected printer, or to save data to a specified storage location just by pressing a single key.

1. Press the [SAVE/RECALL] key.
2. Press the "KEY" softkey.
3. Press the softkey of the required operation:
 - "DEVICE SETTINGS": Stores instrument settings
 - "TRACES": Stores waveforms
 - "SCREENSHOTS": Stores screenshots
 - "SCREEN & SETUP": Stores screenshots and settings
 - "PRINT": Prints directly to a connected printer

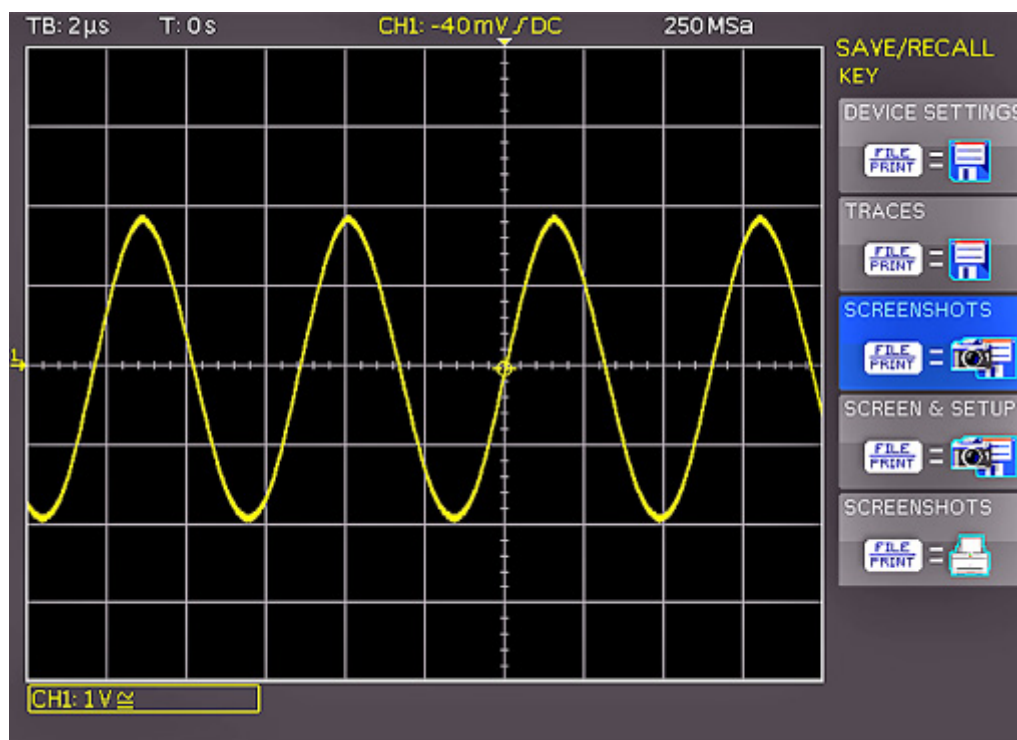

Figure 9-6: Definition of FILE/PRINT key

4. Configure the settings for the selected action as described in the previous sections.
If you press the [FILE/PRINT] key, the selected function is performed.

10 Mixed Signal Operation (Option R&S RTCB1)

The R&S RTC1000 has a connector for the R&S RT-ZL03 logic probe to add 8 digital logic inputs. To use the logic analysis, you need the option R&S RTCB1. The logic probe comes with the option.



Figure 10-1: Optional logic probe R&S RT-ZL03

NOTICE

Ensuring accurate measurement results

The logic analyzer option R&S RTCB1 with connected probe leads is considered as a test probe, according to EN 61326-2-1, clause 5.2.4.101. Therefore, the measurements are sensitive to electromagnetic interference. Consider additional shielding methods to avoid interference.

To ensure accurate measurements, attach the ground lead from the pod to the ground of the device under test if any logic channel of the pod is used for data capture. The ground lead improves signal fidelity to the oscilloscope.

10.1 Using Logic Channels

You can display and adjust logic channels in various ways. Make sure to set the threshold to identify the logic states (high and low) .

- ["To set the threshold for logic states"](#) on page 109
- ["To activate and scale logic channels"](#) on page 109
- ["To reset the position and size of logic channels"](#) on page 110
- ["To label the individual bits of the logic probe"](#) on page 110

To set the threshold for logic states

1. Press the [POD] key.
2. Press the [MENU] key in the Vertical section.
3. Set "SETUP" = "POD".
4. Press "THRESHOLD".
5. Set the threshold:
 - Select the predefined level for "TTL", "CMOS" or "ECL".
 - To set a user-defined level, select "User1" or "User2".
 Adjust the logic level from -2 V to 8 V with the universal knob or the [KEYPAD] key.

To activate and scale logic channels

1. To switch on the digital channels, press the [POD] key in the Vertical section.
 The digital channels 0 to 7 are shown on the screen. A logic "1" is indicated by a bar that is two pixels wide, and a logic "0" is indicated by a bar that is one pixel wide. The logic threshold and a figure which shows the logical states are shown next to the name "POD" in the information field in the bottom left of the display.

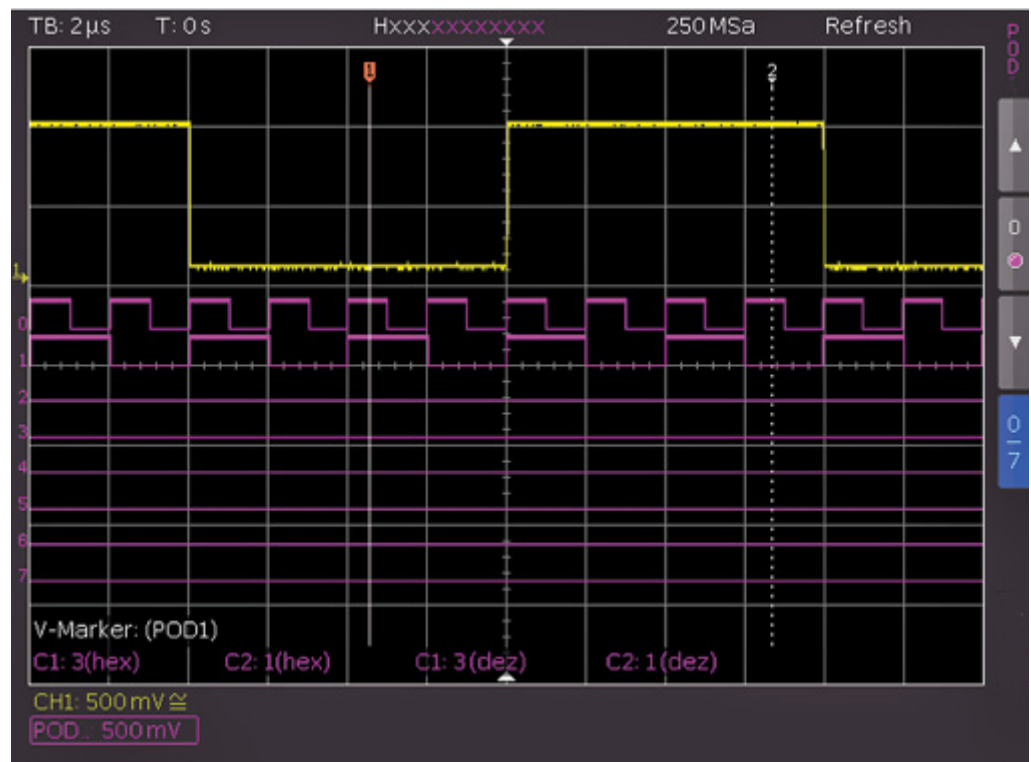

Figure 10-2: Logic channels: display settings

2. Choose the Y-position and the size of the logic channel display as you do for the analog channels:

- a) Press the softkey "0/7" in the short menu until it highlights blue.
 - b) To adjust size and position of all logic channels on the screen, use the vertical [Position] and [Scale] knobs.
3. To resize and position a single channel individually:
 - a) Press the arrow softkeys in the short menu to choose a logic channel.
 - b) Press the softkey between the arrow keys to activate the channel.
 - c) Use the vertical [Position] and [Scale] knobs to adjust size and position of the selected logic channel.

To reset the position and size of logic channels

1. Press the [POD] key in the Vertical section until it lights up.
2. Press the [MENU] key in the Vertical section to open the "POD" menu.
3. Press "SET TO DEFAULT POS. & SIZE" to reset the position and size of the logic channels.

To label the individual bits of the logic probe

1. Press the [POD] key in the Vertical section until it lights up.
2. Press the [MENU] key in the Vertical section to open the "POD" menu.
3. Press "LABEL".
4. Press "BIT" and use the universal knob to select a bit.
5. To switch the display of the label on or off, press the "LABEL" softkey.
6. Press "LIBRARY" to choose a name from the list.
7. Press "EDIT LABEL" to enter a new name or to change the suggested name. You can enter up to 8 characters.
8. Press "ACCEPT" to confirm the name in the editor.

The name is displayed on the grid and the printout. It is assigned to the signal and moves with the waveform.

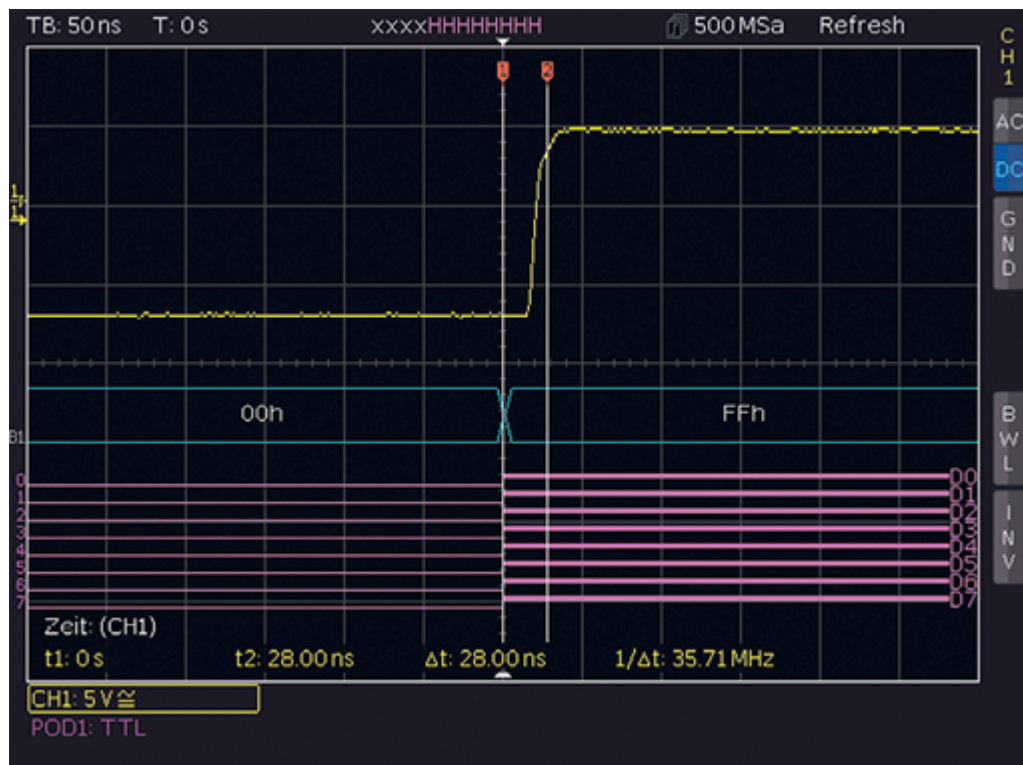

Figure 10-3: Bit DAC signal change

10.2 Logic Trigger for Digital Input

To trigger on logic channels, you can use the logic trigger, see [Chapter 6.5, "Logic Trigger"](#), on page 53.

10.3 Cursor Measurements for Logic Channels

If the logic channels active, you can determine several parameters using cursor measurements ([CURSOR MEASURE] key).

The following measurement types are available:

- TIME:

The display shows the time position of both cursors relative to the trigger time, the time difference between the two positions and the resulting frequency.
- RATIO X:

Three cursors are used to display a time ratio between the first two cursors plus the first and third cursor. The results are shown in floating point format, in percent, in degrees and in radians.
- V-MARKER:

For logic channels, the logic value of the selected POD is measured at the cursor position and shown in hexadecimal and decimal format.

10.4 Automatic Measurements for Logic Channels

If the logic channels active, you can use the automatic measurement functions to determine several parameters ([AUTO MEASURE] key).

The following measurement types are available:

- FREQUENCY
- PERIOD
- PULSE WIDTH +/-
- DUTY CYCLE +/-
- DELAY
- PHASE
- BURST WIDTH
- COUNT PULSE +/-
- COUNT (pos./neg.)

10.5 Using Logic Channels in Buses

You can use logic channels as input sources of various buses. Parallel buses are dedicated for analysis of logic channels. Serial buses accept analog and digital channels as input.

The general usage of buses is described in the following chapters:

- [Chapter 12.1, "Bus Configuration"](#), on page 121
- [Chapter 12.2, "Bus Table: Decode Results"](#), on page 123

10.5.1 Parallel / Parallel Clocked Bus

The R&S RTC1000 has a parallel and parallel bus analysis by default. No option is required. You can analyze up to 7 lines (7 bit).

To select the parallel or parallel bus

1. Press the [BUS] key in the Vertical section.
2. In the short menu, select the bus: "B1" or "B2".
3. In the "BUS" menu, press the softkey "BUS TYPE"
4. Use the [Universal] knob to select "PARALLEL" or " PARALLEL CLOCKED".

To configure the parallel or parallel bus

1. In the "BUS" menu, press "CONFIGURATION".
2. Press "BUS WIDTH". Use the [Universal] knob to select the number of bit lines.
3. Press "SOURCE".
4. Set the source lines of the individual bits:
 - a) Press "PREVIOUS BIT" or "NEXT BIT" repeatedly to select a bit. The selected bit is highlighted in blue.
 - b) Turn the [universal] knob to assign a logic channel to the selected bit. Alternatively, you can press the "SOURCE" repeatedly.
5. If you have selected "PARALLEL CLOCKED" as bus type, press the bottom softkey "CONTROL WIRES" to set the following:
 - a) Press "CHIP SELECT" and select the CS source.
 - b) Press "ACTIVE" to determine whether the chip select signal is active high ("High") or active low ("Low").
 - c) Press "CLOCK" and select the clock source.
 - d) Press "SLOPE" to toggle between rising, falling and both slopes.
6. Press the Back softkey to return to the "BUS" main menu.

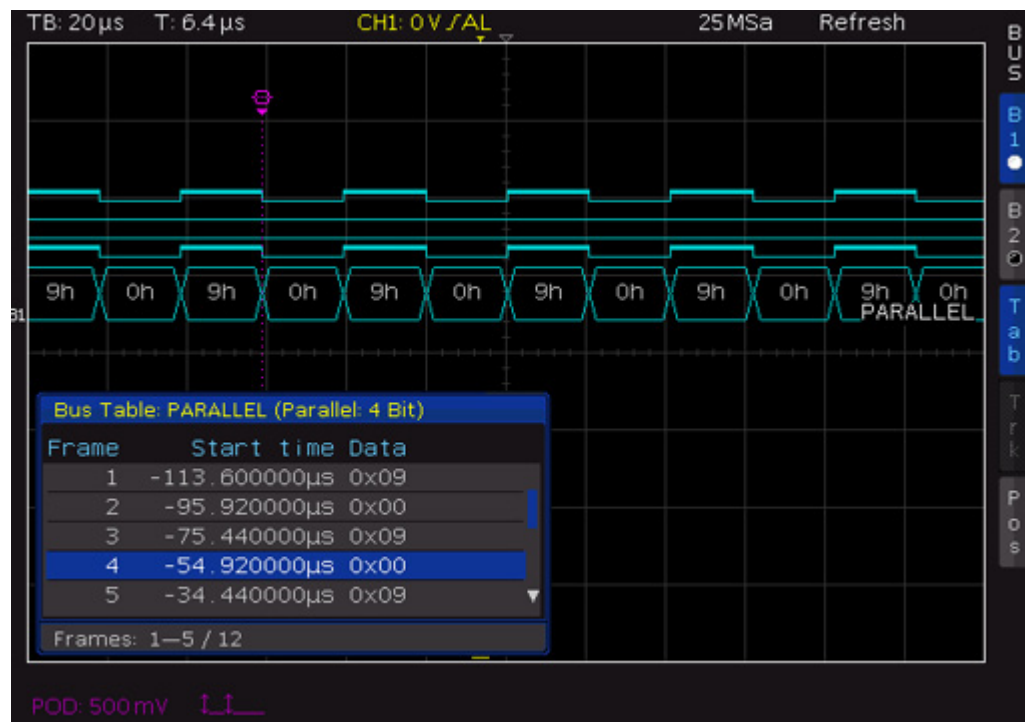

Figure 10-4: Example of a bus table for parallel bus

Table 10-1: Content of the parallel bus table

Column	Description
"Start Time"	Time of frame start in relation to the trigger point
"Data"	Values of the data bytes

To trigger on parallel buses, you can use the logic trigger (see [Chapter 6.5, "Logic Trigger"](#), on page 53).

11 Signal Generation (Option R&S RTCB6)

The signal generation option R&S RTCB6 provides a function generator and a pattern generator. You can find the generator settings in the [UTIL] menu.

To load a predefined function or pattern

The instrument provides a predefined pattern files for the important functions and patterns.

1. Press the [SAVE/RECALL] key.
2. Press "DEVICE SETTINGS".
3. Press "LOAD".
4. Use the Universak knob to select one of the predefined patterns (*. SCP files) from the internal memory.
5. Press "LOAD".

11.1 Function Generator

Using the function generator, you can generate input signals for circuits testing and other purposes. The generated signal is output at the [Aux Out] connector.

1. Press the [UTIL] key in the Vertical section.
2. Press "FUNCTION GEN".
3. Select the parameters of the generated waveform. The parameters are described below.

An information box shows a preview of the generated waveform with the selected parameters.

4. To deactivate the function generator, press "OFF".

FUNCTION

Selects the waveform. The following waveforms can be generated and output at the [Aux Out] connector:

- DC
- Sine: Frequency range from 0.1 Hz to 50 kHz
- Rectangle: Frequency range from 0.1 Hz to 50 kHz
- Pulse: Frequency range from 0.1 Hz to 10 kHz
- Triangle: Frequency range from 0.1 Hz to 10 kHz
- Ramp: Frequency range from 0.1 Hz to 10 kHz

FREQUENCY

Selects the signal frequency. The available range depends on the selected function.

AMPLITUDE

Selects the signal amplitude.

OFFSET

Selects a DC offset.

11.2 Pattern Generator

The pattern generator outputs parallel patterns on the four pins P0 to P3 on the front panel of the instrument. It is based on a 2048-bit wide memory (samples). The pattern can be issued cyclically or individually. It is not possible to issue multiple patterns simultaneously.

To activate the pattern generator

1. Press the [UTIL] key in the Vertical section.
2. Press " PATTERN GEN."
3. Select the pattern.
An information box shows which pins to use.
4. Adjust the settings for the selected pattern.

Table 11-1: Settings for the pattern generator

Pattern	Settings
Square wave	Frequency, polarity, duty cycle
Counter	Frequency, counting direction
Arbitrary	Timing, pattern input
Manual	Manual switching of the 4 individual connectors
UART	Polarity, bit rate
SPI / I ² C / CAN / LIN	Bit rate

11.2.1 Square Wave

You can use "SQUARE WAVE" to perform a manual probe compensation without compensation wizard. The square wave function uses a 100-sample wide pattern (100 conditions). Also, you can change the polarity and the duty cycle (1% to 99%).

11.2.2 Counter

A 4-bit wide counter-pattern is issued. You can determine the counting direction and the frequency. The frequency always refers to the switching of the pattern condition. This results in square waveforms at the individual pins, as described in [Table 11-2](#).

Table 11-2: Counter frequencies

Pin	Frequency
P0	f/2
P1	f/4
P2	f/8
P3	f/16

11.2.3 Arbitrary

You can define a 4 bit wide and a 2048 sample deep arbitrary pattern. The created pattern can be stored and loaded. If a pattern is generated when you call the arbitrary function, the pattern is retained. Thus, you can adapt and analyze the pattern as necessary.

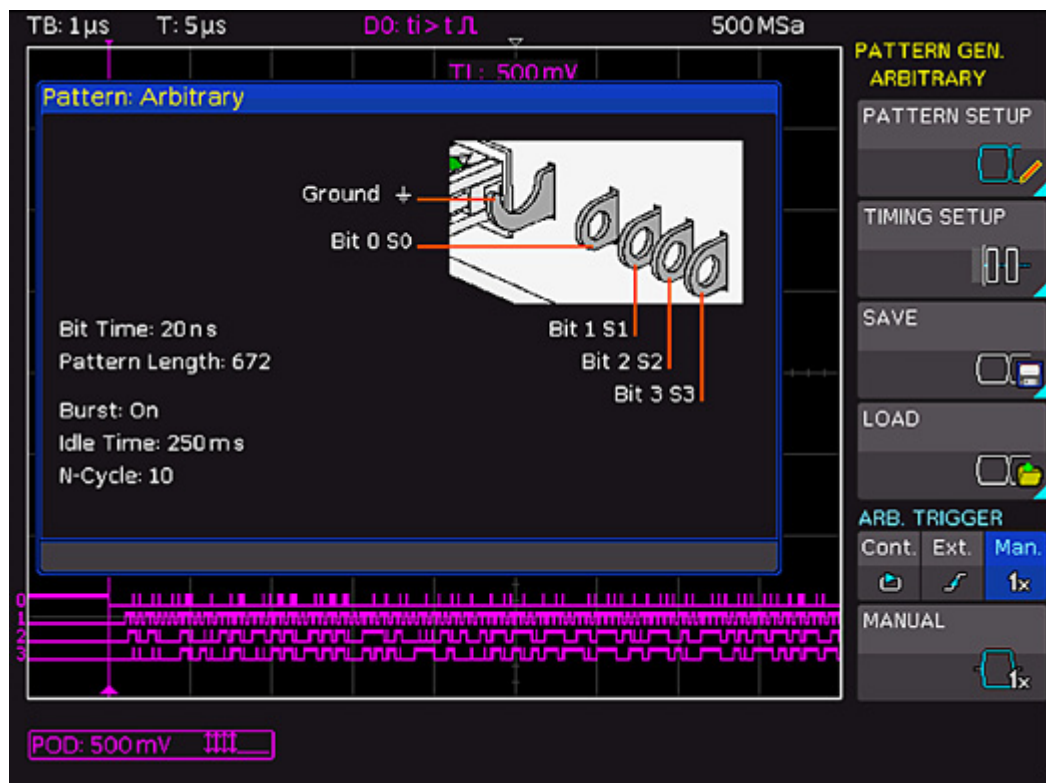

Figure 11-1: Arbitrary menu

The following settings are available:

PATTERN SETUP

Defines the pattern length and bit values.

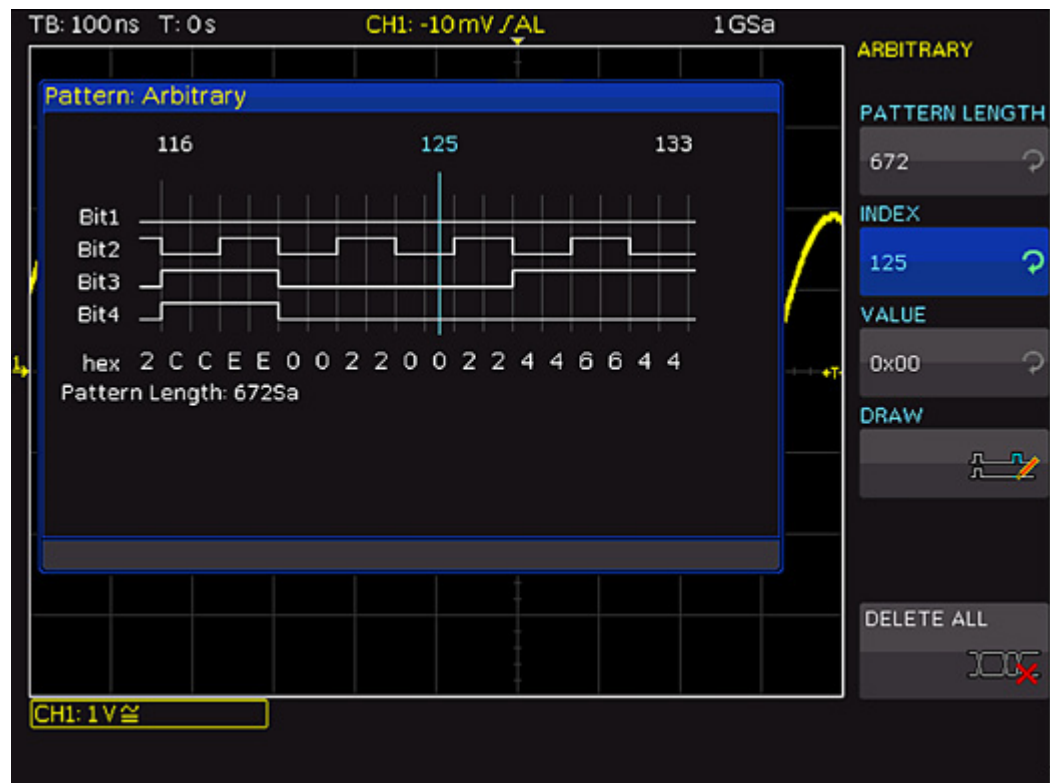

Figure 11-2: Arbitrary pattern setup

"PATTERN LENGTH"	Determines the pattern depth.
"INDEX"	Selects the sample, for which the value is set. The selected sample is marked in the information box by a blue line. Around the index, ± 8 bits are displayed.
"VALUE"	Sets the value of the selected sample.
"DRAW"	Copies the value of the selected sample to the samples before or after by turning the [Universal] knob.
"DELETE ALL"	Deletes the pattern. The pattern length is reset to 1. All values are set to 0.

TIMING SETUP

Defines the time characteristics of the pattern.

"BIT TIME"	Sets length of a bit, how long a sample is applied. The time is identical for all samples.
"PERIOD"	Sets the time of the entire pattern: $Period = Pattern\ length * Bit\ time$. If you change the value, the instrument adjusts the bit time.
"BURST"	If "On", the instrument pauses after each pattern for the duration of the "IDLE TIME". Then the pattern is issued again.
"IDLE TIME"	Sets the waiting time between two patterns from 20 ns to 42 s in increments of 10 ns.

"N-CYCLE" Defines how often a pattern is issued if "BURST" = "On". If the burst is disabled, the setting is not available.

SAVE/LOAD

Saves the created pattern, or loads and applies a previously saved pattern. The pattern can be stored internally or externally on a connected USB flash drive. The pattern settings and the time settings are saved.

ARB. TRIGGER

Defines when the instrument issues the pattern.

"CONT." Issues the pattern continuously. If the burst is enabled, the idle time is applied between the patterns, but the "N-CYCLE" is ignored.

"EXT." The pattern is issued by an edge at the external trigger input of the oscilloscope ([Ext. Trigger In]). You can select the direction of the triggering edge. If "BOTH" is selected, both edges are of equal value. The first edge triggers the pattern. The edges do not alternate. If the burst is enabled, the idle time is applied between the patterns, and the pattern is issued <n> times.

"MAN." The pattern is issued manually by pressing the "MANUAL" key. If the burst is enabled, the idle time number of cycles are applied

11.2.4 Manual

In the manual pattern mode, each pin is assigned to a softkey and the condition High ("H") or Low ("L") is selected.

11.2.5 Serial Buses

On the second page of the PATTERN GEN. menu, you find the settings to generate bus signals for measurements without measurement object. The generated bus signals are pseudo random patterns and are not adaptable. Only the bus type and the data rate can be selected.

The following bus signals can be generated:

- SPI: Data rate 100 kBit/s, 250 kBit/s or 1 MBit/s
- I2C: Data rate 100 kBit/s, 400 kBit/s, 1 MBit/s or 3.4 MBit/s
- UART: Data rate 9600 Bit/s, 115.2 kBit/s and 1 MBit/s
- CAN: up to 50 MBit/s
- LIN: up to 50 MBit/s

The left contact is always ground, the signal levels are about 1 V. The following table shows how the outputs P0, P1, P2 and P3 are used.

Table 11-3: Pin assignment of the bus signal source

Signal	P1	P2	P3	P0 / 
SPI	Clock	MOSI	MISO	Chip Select
I ² C	Data SDA	no signal	no signal	Clock SCL
UART	RX	no signal	no signal	TX
CAN	CAN L	no signal	no signal	CAN H
LIN	Low	no signal	no signal	High

An information box is displayed for each bus, displaying the connector assignment. Adjust the bitrate of the selected bus.

12 Serial Bus Analysis

To trigger and decode serial buses on the digital channels and on the analog inputs, the following options are available:

- R&S RTCK1: I²C and SPI buses
- R&S RTCK2: UART/RS-232 buses
- R&S RTCK3: CAN and LIN buses



The serial bus analysis is performed with 1/8 of the sampling rate.

The usage of digital channels requires the logic probe R&S RT-ZL03 and option R&S RTCB1.

In the "BUS" menu, you find also the settings for parallel buses. Parallel buses are dedicated for analysis of logic channels and described in [Chapter 10, "Mixed Signal Operation \(Option R&S RTCB1\)"](#), on page 108.

The analysis of parallel and serial data consists of the following three basic steps:

- Protocol configuration (bus type / protocol-specific settings)
- Decoding (Display of decoded data / zoom / bus table)
- Trigger (Start / stop / serial pattern)

12.1 Bus Configuration

Before you can adjust the settings for the trigger and decoding functions, you must define a bus. Two buses, B1 and B2, can be defined.



Before you configure the bus, set the correct logic level (threshold).

- For analog channels, see ["THRESHOLD menu"](#) on page 37.
- For digital channels, see ["To set the threshold for logic states"](#) on page 109. The default value is 500 mV.

To define a bus

1. Press the [BUS] key in the Vertical section until it lights up in white.
2. In the short menu, press the softkey "B1" or "B2" until a menu opens. Alternatively, press the [MENU] button in the Vertical section and press the top softkey to define the bus.
3. Press "BUS TYPE" and use the [Universal] knob to select one of the following bus types:
 - "PARALLEL" and "PARALLEL CLOCKED": analysis of logic channels, see [Chapter 10.5.1, "Parallel / Parallel Clocked Bus"](#), on page 112.
 - "SSPI" (available with R&S RTCK1)

- "SPI" (available with R&S RTCK1)
- "I²C" (available with R&S RTCK1)
- "UART" (available with R&S RTCK2)
- "CAN" (available with R&S RTCK3)
- "LIN" (available with R&S RTCK3)

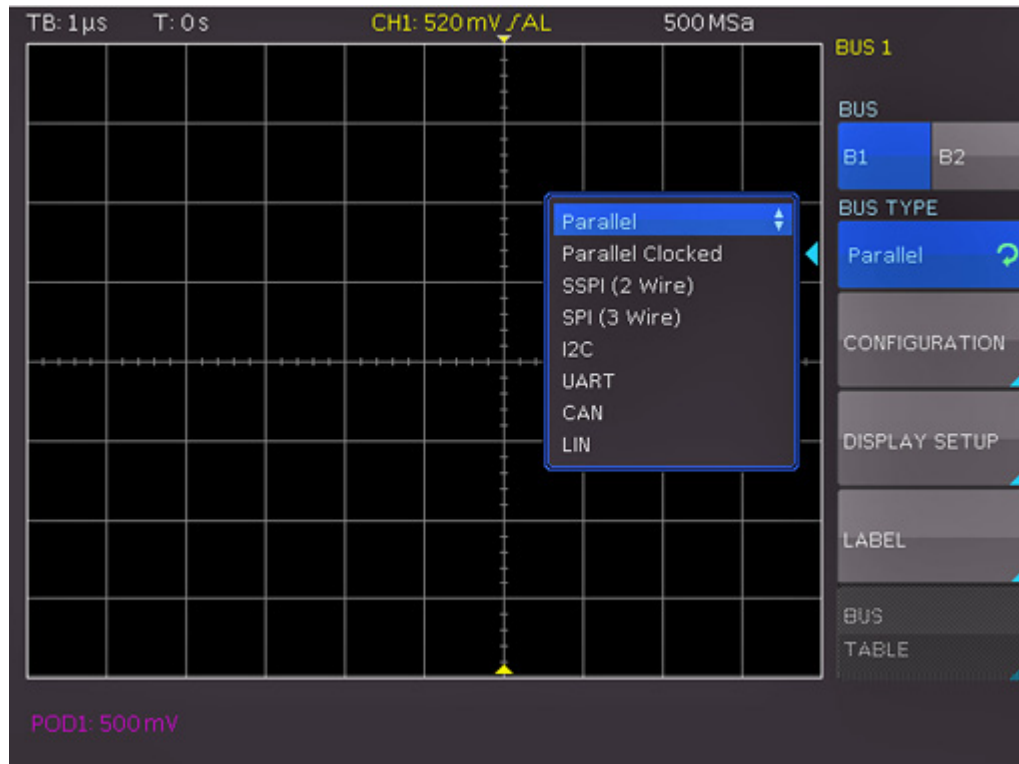

Figure 12-1: Menu for bus definition

To configure the selected bus type

- ▶ Press "CONFIGURATION".

The configuration menu for the selected bus type opens. A menu description can be found in the chapters describing the bus types.

To define the display settings:

1. Press "DISPLAY SETUP".
2. Press "DISPLAY" repeatedly to select one of the following decoding formats:
 - Binary
 - Hexadecimal
 - Decimal
 - ASCII
3. Press "BITS" to activate or deactivate the display of individual bit lines above the table display.

To enter a bus name

1. Press "LABEL".
2. To switch on or off the label display, press "LABEL".
3. To choose a name from a predefined list, press "LIBRARY"
4. To enter a new name or to customize the suggested name, press "EDIT LABEL".
You can enter up to 8 characters.
Press "ACCEPT" to confirm the name in the editor.
The name is displayed on the grid and the printout.

12.2 Bus Table: Decode Results

The bus table shows the decode results of the bus. You can adjust the content of the table, and export the decode data to a file.

The table content is protocol-specific. You can activate the table display for each bus type.

To activate the bus table

1. In the "BUS" menu, press "BUS TABLE" to open the menu.
2. To activate the bus table, press "BUS TABLE".



Make sure that a complete message of a serial protocol is displayed on the screen to ensure that decoding can function properly. Use the zoom function to see details of the message.

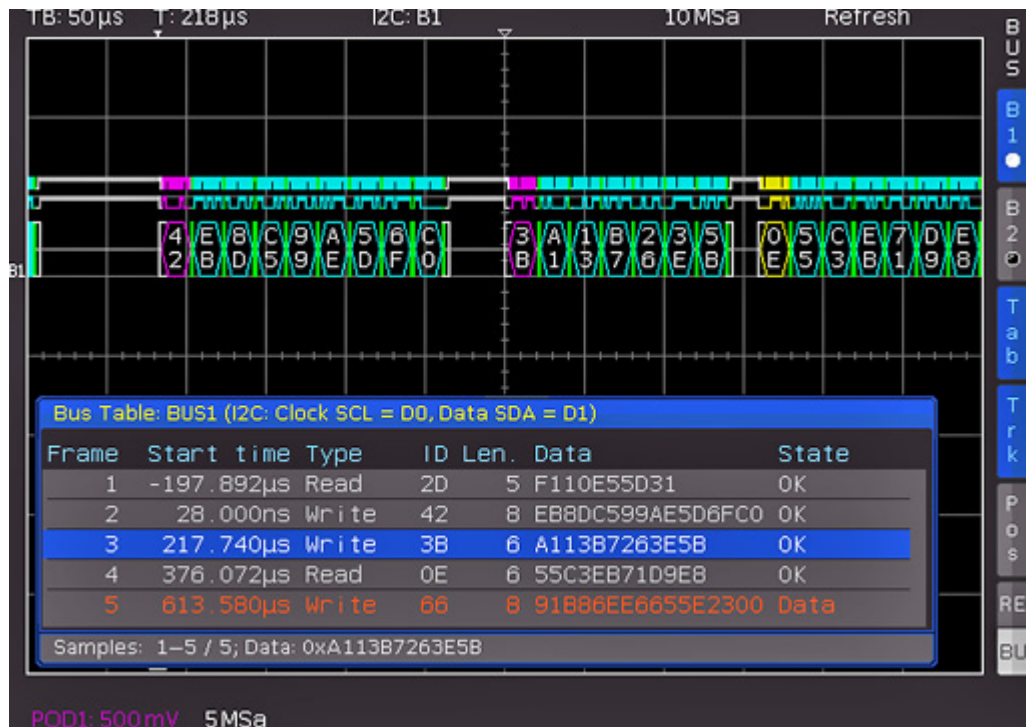

Figure 12-2: Example of I2C BUS with bus table

To export the decode results

1. Stop the acquisition.
2. In the "BUS TABLE" menu, press "SAVE".
3. Connect a USB flash drive to the instrument.
4. Save the bus table.

For each frame, one line is written to the file, for example:

```
"Bus table: BUS1 (I2C: Clock SCL = D0, Dates SDA = D1)"
Frame,Mark,Start time[s],Type,ID,Length,Date,Condition
1,,-197.89200e-6,Read,0x2D,5,0xF110E55D31,OK
2,,28.00000e-9,Write,0x42,8,0xEB8DC599AE5D6FC0,OK
3,,217.74000e-6,Write,0x3B,6,0xA113B7263E5B,OK
4,,376.07200e-6,Read,0x0E,6,0x55C3EB71D9E8,
OK
5,,613.58000e-6,Write,0x66,8,0x91B86EE6655E2300,Data Error
```

The "BUS TABLE" menu provides the following settings:

BUS TABLE

Activates or deactivates the list view. Generally, a complete message (frame) of a protocol is displayed in a row. The columns contain time information, data, and address message if applicable. The number of rows in the table is identical to the number of complete message frames in the instrument memory. The softkey "TAB" in the "BUS" short menu activates or deactivates the bus table without opening a menu.

TRACK FRAME

Enables scrolling the bus table and simultaneously jump to the selected position in the memory using the [Universal] knob. Tracking is only possible if acquisition has been stopped. This function is also available in the short "BUS" menu: "TRK" (= Track).

FRAME TIME DIFFERENCE

If activated, the bus table shows the time difference to the previous frame (data packet). This column is labeled as "TIME DIFF".

If deactivated, the absolute time in relation to the trigger point is displayed in the column "START TIME".

POSITION

Moves the bus table to the top or bottom of the screen, or displays the bus table in full screen. You can also use the softkey "POS" in the "BUS" short menu to toggle the position.

SAVE

Saves the decoding results in a CSV file on USB flash drive.

12.3 I²C Bus (Option R&S RTCK1)

For I²C bus trigger and decoding, you need the R&S RTCK1 option.

The I²C bus is a two-wire bus, which was developed by Philips (today known as NXP Semiconductor).

An I²C bus has the following properties:

- Two wires: clock (SCL) and data (SDA).
- Master-slave communication: the master provides the clock pulse and selects the slave.
- Addressing: Each slave can be addressed with a unique address. Multiple slaves can be linked with each other and can be addressed by the same master.
- Read/Write bit: Master reads data (= 1) or writes data (= 0).
- Acknowledge bit: issued after each byte

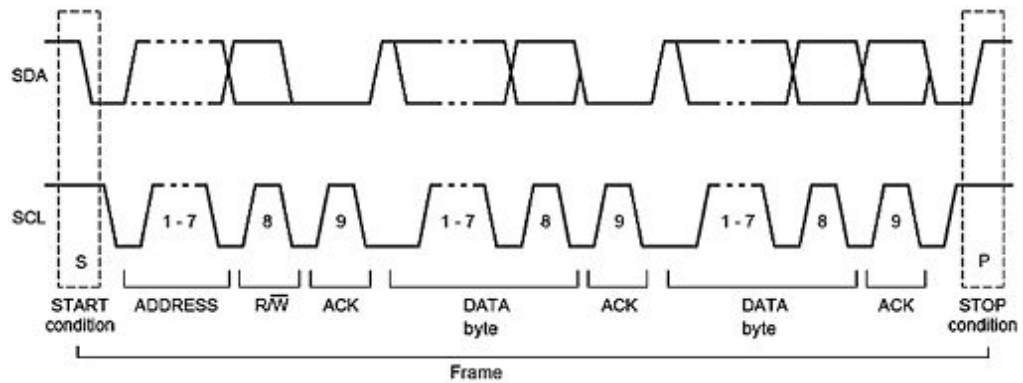

Figure 12-3: I²C 7-bit address

The format of a simple I²C message (frame) with an address length of 7 bit has the following structure:

- Start condition: falling slope on SDA (serial data), while SCL (serial clock) is high
- 7-bit address (write or read slave)
- Read/Write bit (R/W): indicates if the data is to be written or read out from the slave
- Acknowledge bit (ACK): is issued by the recipient of the previous byte if transmission was successful. Exception: for read access, the master terminates the data transmission with a NACK bit after the last byte.
- Data: a series of data bytes with an ACK bit after each byte
- Stop condition: rising slope on SDA (serial data), while SCL (serial clock) is high

12.3.1 I²C Bus Configuration



Before you configure the bus, set the correct logic level (threshold).

- For analog channels, see "[THRESHOLD menu](#)" on page 37.
- For digital channels, see "[To set the threshold for logic states](#)" on page 109. The default value is 500 mV.

To select the I²C bus

1. Press the [BUS] key in the Vertical section.
2. In the short menu, select the bus: "B1" or "B2".
3. In the "BUS" menu, press the softkey "BUS TYPE"
4. Use the [Universal] knob to select "I2C".

To decode the I²C bus, the instrument needs information which logic channel is connected to the clock (SCL) and which is connected to the data line (SDA).

To configure the I²C bus

1. In the "BUS" menu, press "CONFIGURATION".
2. To select the source channel, press "CLOCK SCL". Use the [Universal] knob to select.
3. To define the data channel, press "DATA SDA" and use the [universal] knob.
4. Press "7BIT ADDRESS" to choose whether the address is interpreted inclusive ("ADR.+ RW") or without the Read/Write bit ("ADDR. ONLY").

A small window provides information about the current settings.

5. Press the Back softkey twice to close all menus.

12.3.2 I²C Bus Triggering

After the bus configuration is completed, you can trigger on various events.

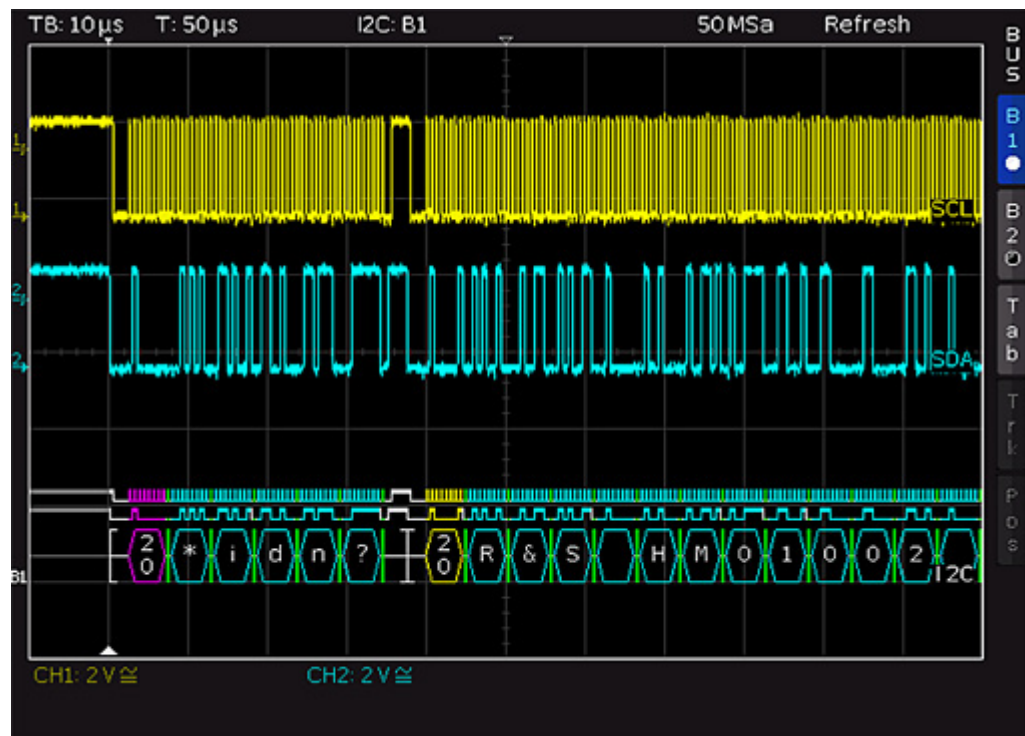

Figure 12-4: I²C bus

To trigger on events

1. In the Trigger section, press the [TYPE] key.
2. Select "SERIAL BUS".
3. Press the [SOURCE] key in the Trigger section.
4. Choose the "I²C" bus by pressing the respective softkey.

The bus is only available if it is configured correctly.

5. Press the [FILTER] key in the Trigger section to list all available I²C trigger conditions.
6. Configure the trigger condition. Possible conditions are described below.
7. Press the Back softkey until all menus are closed.
The oscilloscope triggers on the condition. For measurements without measuring object, refer to chapter [Chapter 11.2.5, "Serial Buses"](#), on page 119.

START

Triggers on the frame start sequence. The start sequence is the falling slope on SDA when SCL is high.

STOP

Triggers on the frame stop sequence. The stop signal is the rising slope on SDA when SCL is high.

RESTART

Triggers if a new start sequence occurs before the stop condition. The new start signal is a repeated start signal.

NOT-ACKNOWLEDGE

The NOT-ACKNOWLEDGE bit is the 9th bit in a data or address pattern of the SDA line. For NOT-ACKNOWLEDGE, the acknowledge bit is high on SDA, although it should be low.

READ/WRITE

Sets the following additional trigger options:

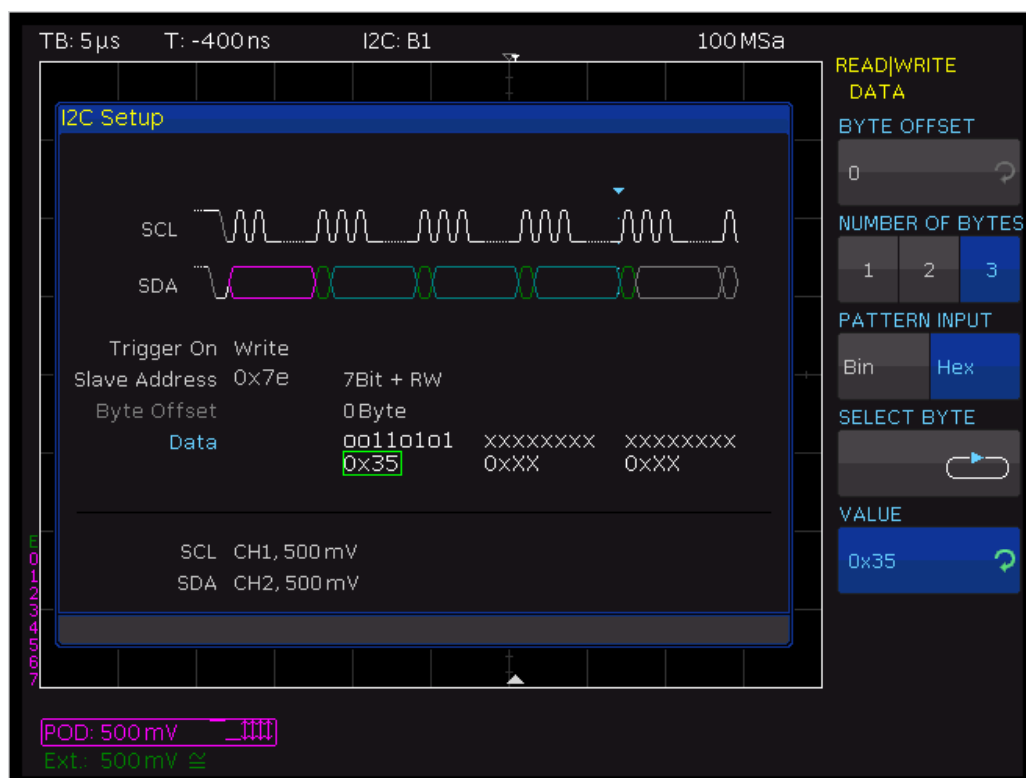

Figure 12-5: Read/Write trigger menu

- "MASTER" Toggles the trigger condition between read and write access. The 8th bit of the first data unit (depending on the address length) is used to distinguish between read and write access. The selected condition is displayed in the I²C settings window.
- "ADDRESS LENGTH" Defines the address length, and thus the maximum number of slave addresses. For a 7-bit address length, the maximum number of available addresses is 112. The 10-bit addressing mode is downward compatible with the 7-bit addressing mode by using 4 of 16 reserved addresses and can be used simultaneously. For a 10-bit address length, a total of 1136 addresses (1024 + 128 - 16) is available. The highest 10-bit address is 1023 (0x3FF). The selected address length is displayed in the I²C settings window.
- "SLAVE ADDRESS" Sets the address of the slave the master communicates with. Use the [Universal] knob to select the address to be triggered.
- "DATA" Trigger on a specific address and/or data pattern. See "DATA" on page 129.

DATA

"DATA" triggers on specific data in addition to the address. You can trigger on clearly defined data bytes (color cyan) within the transmission, allowing you to filter out irrelevant transmissions. You can trigger on up to 24 bit (3 bytes) of data. An offset of 0 to 4095 to the address is allowed.

BYTE OFFSET ← DATA

Defines the number of bytes to be ignored before the relevant bytes of the trigger condition. Usually, the byte offset is zero if the trigger is to occur on the maximum first 24 bits after the address.

NUMBER OF BYTES ← DATA

Defines how many bytes are to be analyzed for the trigger condition.

PATTERN INPUT ← DATA

You can define the bit pattern in binary or hexadecimal format.

If binary input is selected, use "SELECT BIT" and the [Universal] knob to select the bit. Then press "STATE" to set the state H (=1), L (=0) or X (do not care) for the selected bit. The state X defines any state. Repeat until all bits are set.

If hexadecimal input is selected, only the entire byte can be set to X. Use the softkey "SELECT BYTE" to choose one of the bytes, depending on the available number of bytes. Use the softkey "VALUE" and the [universal] knob to set the byte value. The active byte is marked with a green border in the display window of the trigger condition (see [Figure 12-5](#)).

12.3.3 I²C Decode Results

Certain portions of the I²C messages are displayed in color to distinguish between the different parts. If the data lines are selected in the bus table, the respective sections are also displayed in color.

- Read address: Yellow
- Write address: Magenta
- Data: Cyan
- Start: White
- Stop: White
- No acknowledge: Red
- Acknowledge: Green

The bus table lists the decode results. See also: [Chapter 12.2, "Bus Table: Decode Results"](#), on page 123.

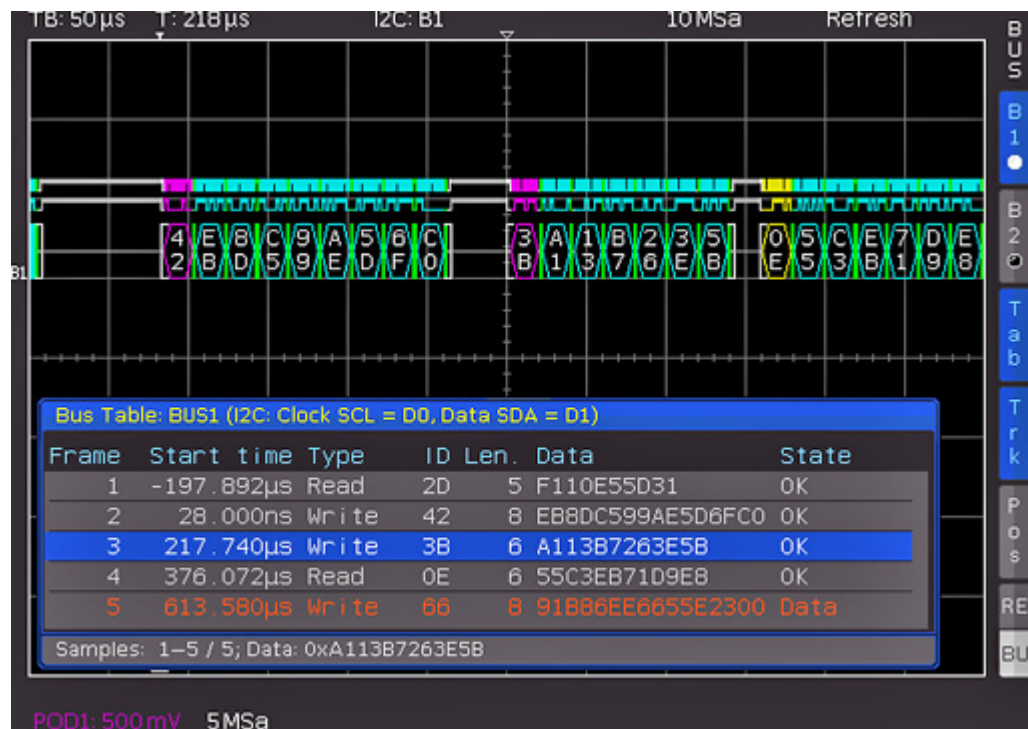

Figure 12-6: I2C bus table

Table 12-1: Content of the I²C bus table

Column	Description
"Start Time"	Time of frame start in relation to the trigger point
"Type"	Value of the R/W bit (Read/Write)
"ID"	Value of address
"Length"	Number of words in the frame
"Data"	Values of the data words
"State"	Frame state: <ul style="list-style-type: none"> • "OK" = frame is valid • "DATA" = during acquisition start/end only the frame start / frame end has been decoded; currently no data available • "ADDR. ERR." = incomplete frame decoding • "INS" = the frame is not contained in the acquisition; the acquired part of the frame is valid.

12.4 SPI / SSPI BUS (Option R&S RTCK1)

For SPI/SSPI bus trigger and decoding, you need the R&S RTCK1 option.

The Serial Peripheral Interface SPI is used to communicate with slow peripheral devices, in particular for the transfer of data streams. The SPI bus was developed by Motorola; however, it has not been formally standardized. Generally, it is a bus with clock and data lines and a select line (3-wire). If only one master and one slave are

present, the select line can be deleted. This type of line is also called SSPI (Simple SPI) (2-wire).

An SPI bus has the following properties:

- Master-slave communication
- No instrument addressing
- No acknowledge to confirm data reception
- Duplex capability

Most SPI buses have four common lines, two data lines and two control lines:

- Clock to all slaves (SCLK)
- Slave select or chip select lines (SS or CS)
- Master-Out-Slave-In, Slave-Data-Input (MOSI or SDI)
- Master-In-Slave-Out, Slave-Data-Output (MISO or SDO)

If the master generates a clock pulse and selects a slave, data can be transmitted in either one direction or simultaneously in both directions.

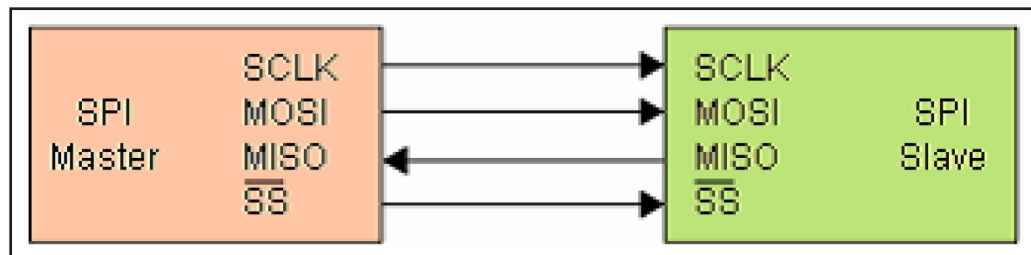

Figure 12-7: Simple configuration of SPI bus

12.4.1 SPI / SSPI Bus Configuration



Before you configure the bus, set the correct logic level (threshold).

- For analog channels, see "[THRESHOLD menu](#)" on page 37.
- For digital channels, see "[To set the threshold for logic states](#)" on page 109. The default value is 500 mV.

For 3-wire SPI, the external trigger input is used as CS (Chip Select). The threshold can be set in the bus configuration menu.

To select the SPI or SSPI bus

1. Press the [BUS] key in the Vertical section.
2. In the short menu, select the bus: "B1" or "B2".
3. In the "BUS" menu, press the "BUS TYPE" softkey.
4. Use the [Universal] knob to select:
 - "SSPI" for a 2-wire SPI system.

- "SPI" for a 3-wire SPI system.

To configure the SPI bus

1. In the "BUS" menu, press "CONFIGURATION".
2. Press "SOURCE" to select the chip select ("CS"), clock ("Clk") or data line ("Data").

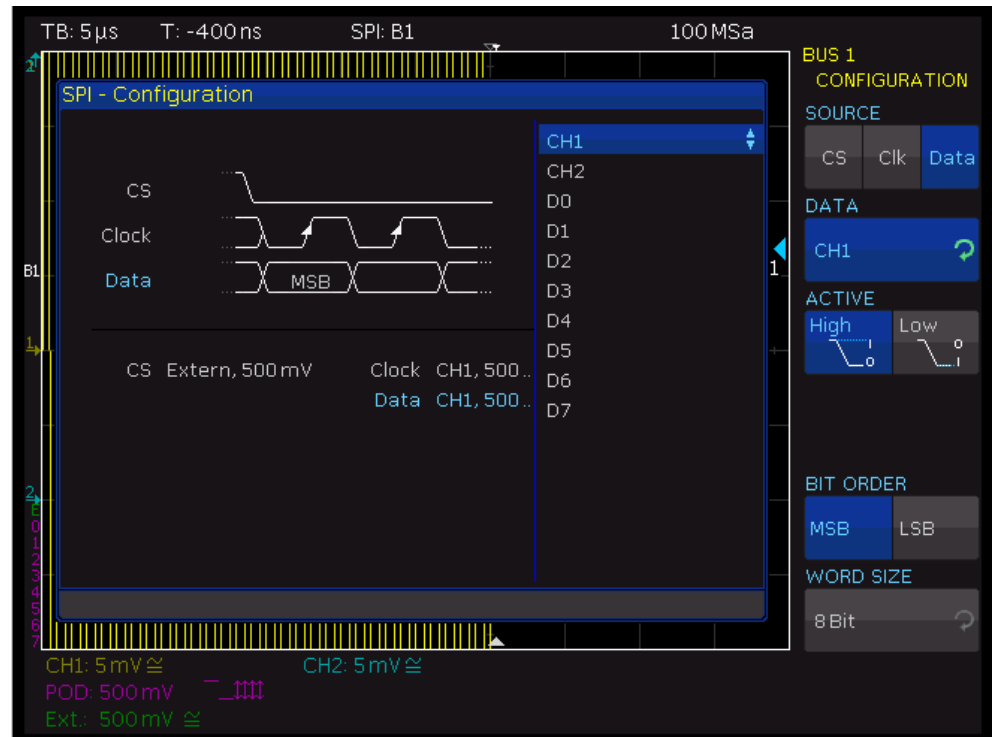

Figure 12-8: Menu for the definition of an SPI bus

3. Press the second softkey ("CHIP SELECT", "CLOCK", or "DATA". Use the [Universal] knob to select the source channel.
4. If "CS" is selected, press "ACTIVE" to set high or low active (low active is the default setting).
5. If "Clk" is selected, press "SLOPE" to decide whether the data is stored with rising or falling slope (rising slope is the default setting).
6. If "Data" is selected, press "ACTIVE" to assign whether data is high or low active (high active is the default setting).
7. Press "BIT ORDER" to determine if the data of each message starts with the "MSB" (most significant bit) or the "LSB" (least significant bit).
8. Press "WORD SIZE" to select with the [Universal] knob how many bits are included in each message. You can select a value between 1 bit and 32 bits.

To configure the SSPI bus

1. In the "BUS" menu, press "CONFIGURATION".

2. Press "SOURCE" to select the clock ("Clk"), data line ("Data"), and the timeout ("Time").
3. If "Clk" is selected:
 - a) Press "CLOCK".
 - b) Select the input channel of the clock line.
 - c) Press "SLOPE" to decide whether the data is stored with rising or falling slope (rising slope is the default setting).
4. If "Data" is selected:
 - a) Press "DATA".
 - b) Select the input channel of the data line.
 - c) Press "ACTIVE" to assign whether data is high or low active (high active is the default setting).
5. If "Time" is selected, press "TIME OUT". Use the [Universal] knob to set the idle time.
6. Use the top softkey "SOURCE" to select the respective channel for clock ("Clk") and data ("Data") or to select the time-out time ("Time").
 During the time-out, data and clock line are at Low. When the time-out has been reached, a new frame begins. If the time intervals between the data packets are shorter than the time-out, these packets belong to the same frame. A small window provides information about the current settings.
7. Press "BIT ORDER" to determine if the data of each message starts with the "MSB" (most significant bit) or the "LSB" (least significant bit).
8. Press "WORD SIZE" to select with the [Universal] knob how many bits are included in each message. You can select a value between 1 bit and 32 bits.

12.4.2 SPI / SSPI Bus Triggering

After the bus configuration is completed, you can trigger on various events.

To trigger on events

1. In the Trigger section, press the [TYPE] key.
2. Select "SERIAL BUS".
3. Press the [SOURCE] key in the Trigger section.
4. Choose "SPI" or "SSPI" by pressing the respective softkey.
The bus is only available if it is configured correctly.
5. Press the [FILTER] key in the Trigger section to list the trigger conditions of the bus.
6. Configure the trigger condition. Possible conditions are described below.
7. Press the Back softkey until all menus are closed.

The oscilloscope triggers on the condition. For measurements without measuring object, refer to chapter [Chapter 11.2.5, "Serial Buses"](#), on page 119.

FRAME START

Triggers on the start of the frame. The frame starts when the chip select ("CS") signal switches to the selected active mode, or when the time-out exceeded, at the next clock edge.

FRAME END

Triggers on the end of the frame. The frame ends when the chip select ("CS") signal switches from the selected active to the inactive mode, or when the time-out exceeded.

BIT

Triggers on the selected bit within the bit sequence. Use the [Universal] knob or the [KEYPAD] to set the bit number.

SER. PATTERN

Triggers on a specific bit pattern at a given position in the frame.

BIT OFFSET ← SER. PATTERN

Defines the position of the first bit of the configured bit sequence within the frame. The bits in front of it have no impact on the trigger event. For example, if the bit offset = 2, bit 0 and bit 1 after CS are ignored and the pattern begins with bit 2. You can select a value between 0 and 4095 using the [Universal] knob or the [KEYPAD].

NUMBER OF BITS ← SER. PATTERN

Sets the number of bits are analyzed for the trigger condition. You can select a value between 1 bit and 32 bit.

PATTERN INPUT ← SER. PATTERN

See "[PATTERN INPUT](#)" on page 130.

12.4.3 SPI / SSPI Decode Results

Certain parts of the SPI/SSPI messages are displayed in color to distinguish between the different elements:

- White: Start / End of complete frame
- Red: Incomplete word that is not contained in the acquisition; change the horizontal scale or move the "Time Reference" to get a longer acquisition
- Cyan: Decoded words

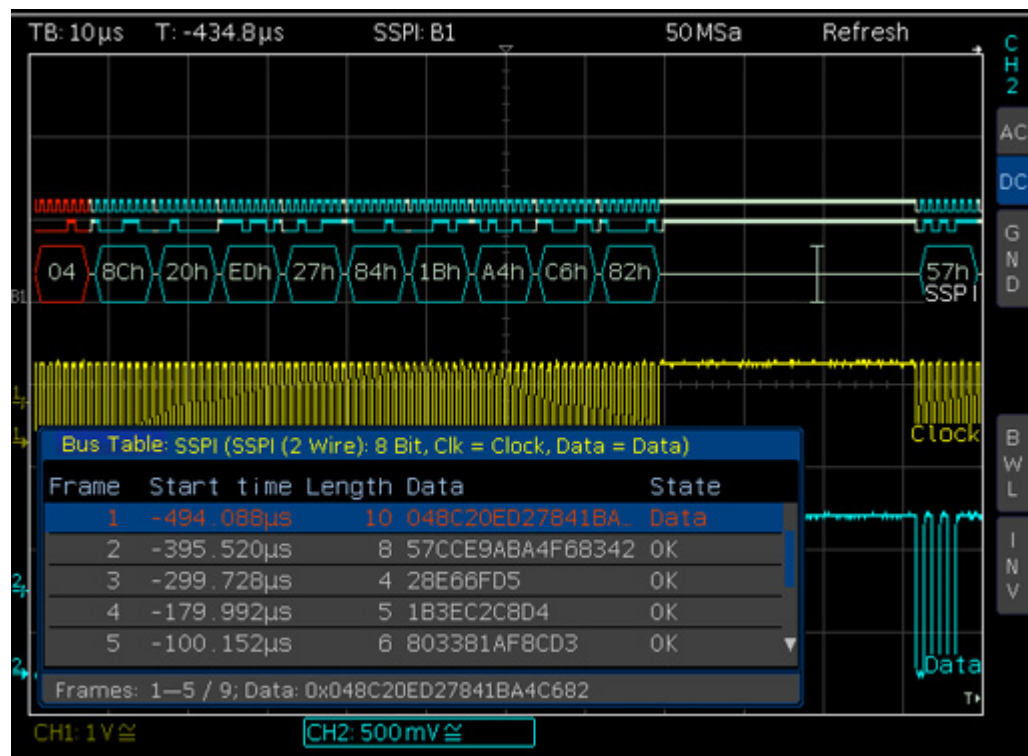

Figure 12-9: Example of an SSPI bus table

Table 12-2: Content of the SPI/SSPI bus table

Column	Description
"Start Time"	Time of frame start in relation to the trigger point
"Length"	Number of words in the frame
"Data"	Values of the data words
"State"	Frame Status: <ul style="list-style-type: none"> • "OK" = frame is valid • "DATA" = during acquisition start/end only the frame start / frame end has been decoded; currently no data available • "INS" = the frame is not contained in the acquisition; the acquired part of the frame is valid.

12.5 UART/RS-232 BUS (Option R&S RTCK2)

For UART/RS-232 bus trigger and decoding, you need the R&S RTCK2 option.

The UART bus (Universal Asynchronous Receiver Transmitter) is a general bus system and the base for many protocols. One example is the RS-232 protocol. It consists of a frame with a start bit, 5 to 9 data bits, one parity bit and a stop bit. The stop bit can assume the single length, or 1.5 or twice the length of a normal bit.

Start Data0 Data1 [Data8] [Parity] Stop

Figure 12-10: UART bit sequence

12.5.1 UART/RS-232 Bus Configuration



Before you configure the bus, set the correct logic level (threshold).

- For analog channels, see "[THRESHOLD menu](#)" on page 37.
- For digital channels, see "[To set the threshold for logic states](#)" on page 109. The default value is 500 mV.

To select the UART bus

1. Press the [BUS] key in the Vertical section.
2. In the short menu, select the bus: "B1" or "B2".
3. In the "BUS" menu, press the "BUS TYPE" softkey.
4. Use the [Universal] knob to select "UART":

To configure the UART bus

1. In the "BUS" menu, press "CONFIGURATION".
2. Configure the bus. The settings are located on two menu pages. They are described below.

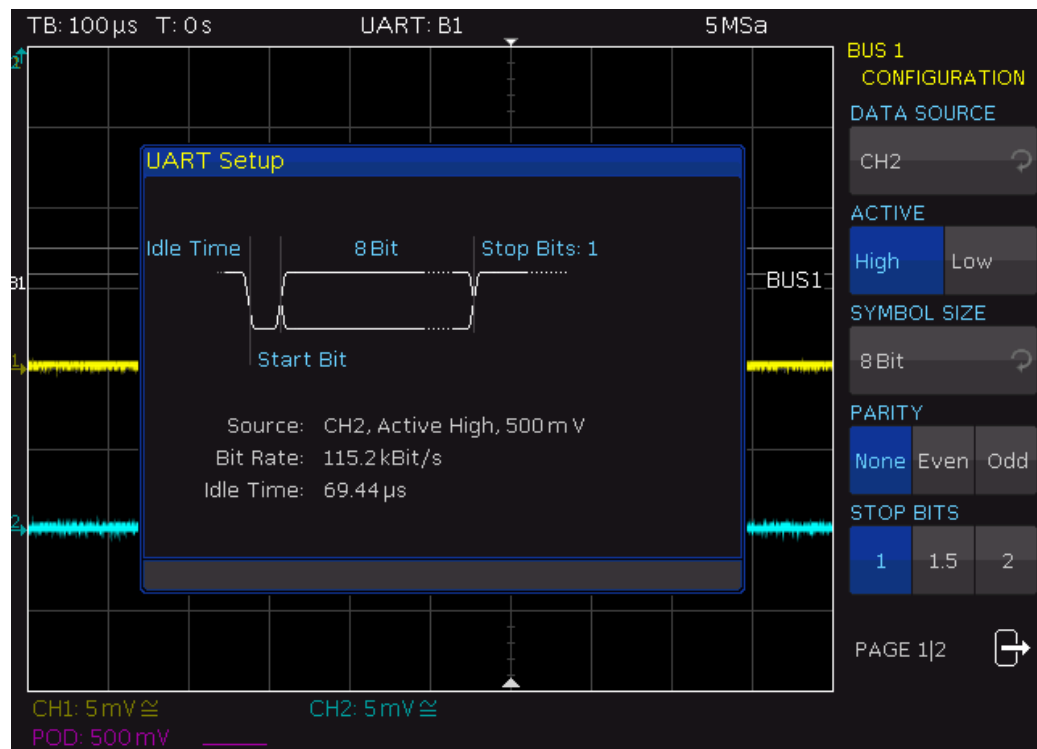

Figure 12-11: Page 1|2 UART bus setup menu

DATA SOURCE

Selects the channel which is connected to the data line.

ACTIVE

Determines if the data transferred are active high (high = 1) or active low (low = 1). For RS-232, choose active low.

SYMBOL SIZE

Selects a value between 5 bit to 9 bit for the bits that form a symbol.

PARITY

Parity bits are used to detect errors during a transmission:

- "None" No parity bits
- "Even" If the number of ones in a specific set of bits is uneven (without parity bit), the parity bit is set to "1".
- "Odd" If the number of ones in a specific set of bits is uneven (without parity bit), the parity bit is set to "1".

STOP BITS

Sets the number of stop bits: 1 or 1.5 or 2 stop bits are possible.

BIT RATE, USER

The bit rate defines how many bits are sent per second. To select a standard bit rate, use "BIT RATE". To define a customized rate, use "USER".

IDLE TIME

Sets the minimum time between the stop bit of the last data and the start bit of the new data. The idle time defines the start of a transmission and the exact start of a frame (one or more symbols, most commonly bytes). The idle time is important for correct decoding and triggering, regardless of the trigger type. A start bit within the idle time is not recognized. You can enter the value using the [Universal] knob or the [KEYPAD].

12.5.2 UART/RS-232 BUS Triggering

After the bus configuration is completed, you can trigger on various events.

To trigger on events

1. In the Trigger section, press the [TYPE] key.
2. Select "SERIAL BUS".
3. Press the [SOURCE] key in the Trigger section.
4. Choose "UART" by pressing the respective softkey.
The bus is only available if it was configured earlier.
5. Press the [FILTER] key in the Trigger section to list the trigger conditions of the bus.
6. Configure the trigger condition. Possible conditions are described below.
7. Press the Back softkey until all menus are closed.
The oscilloscope triggers on the condition. For measurements without measuring object, refer to chapter [Chapter 11.2.5, "Serial Buses"](#), on page 119.

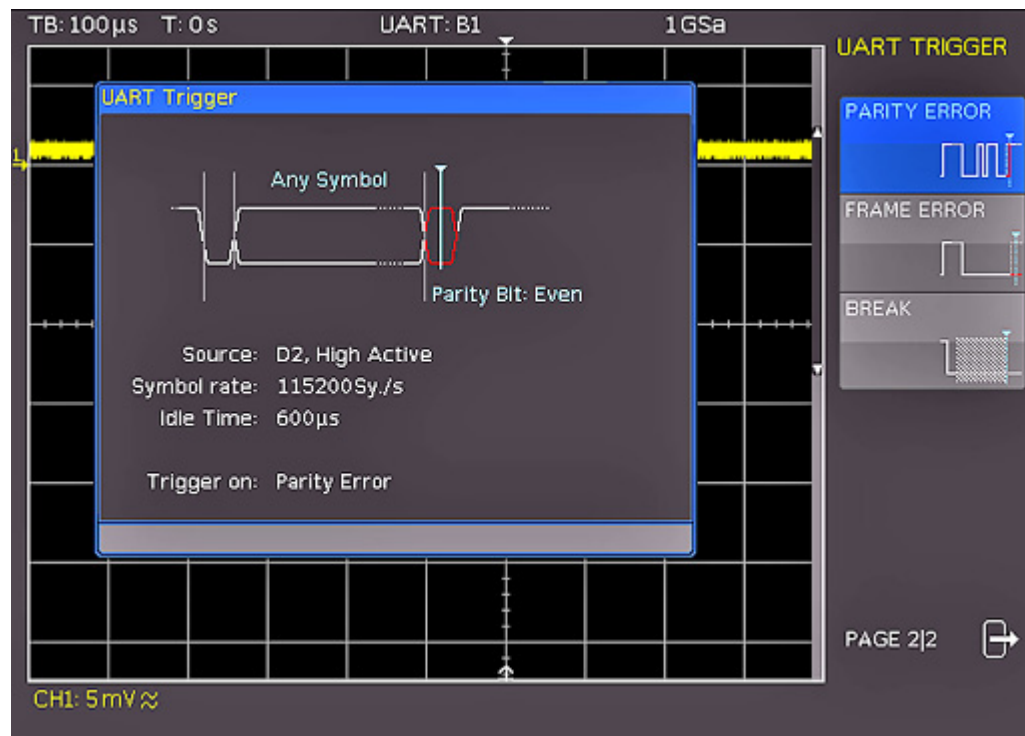

Figure 12-12: UART trigger menu page 2

START BIT

Sets the start bit as trigger event. The start bit is the first low bit after a stop bit.

FRAME START

Defines the first start bit after idle time (= frame start) as trigger condition.

SYMBOL <N>

Triggers on the Nth symbol in a frame.

ANY SYMBOL

Triggers on a symbol pattern anywhere within a frame. See "[PATTERN INPUT](#)" on page 130.

PATTERN

Configures a data pattern of one or more symbols as trigger condition.

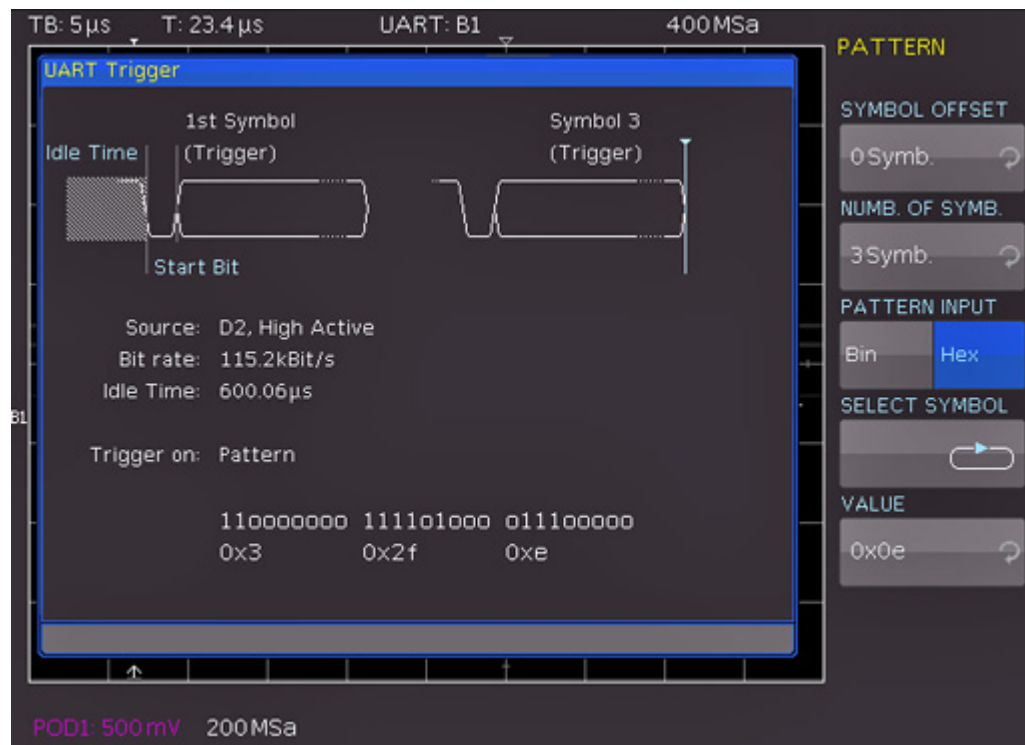

Figure 12-13: Trigger menu to trigger on a data pattern

"SYMBOL OFFSET"	Selects the number of irrelevant symbols that proceed the pattern. Any value between 0 to 4095 symbols after the start bit can be entered.
"NUMB. OF SYMB."	Selects the number of symbols included in the pattern, the pattern size. The symbol length is configured in the bus configuration.
"PATTERN INPUT"	See " PATTERN INPUT " on page 130.

PARITY ERROR

Triggers on a parity error.

FRAME ERROR

Triggers on a frame error.

BREAK

Triggers on a break. The condition is fulfilled if a stop bit does not succeed a start bit within a specified time period.

12.5.3 UART Decode Results

Certain portions of the UART messages are displayed in color to distinguish between the different elements:

- White: Start / End of complete frame

- Red: Incomplete word that is not contained in the acquisition; change the horizontal scale or move the "Time Reference" to get a longer acquisition
- Cyan: Decoded words

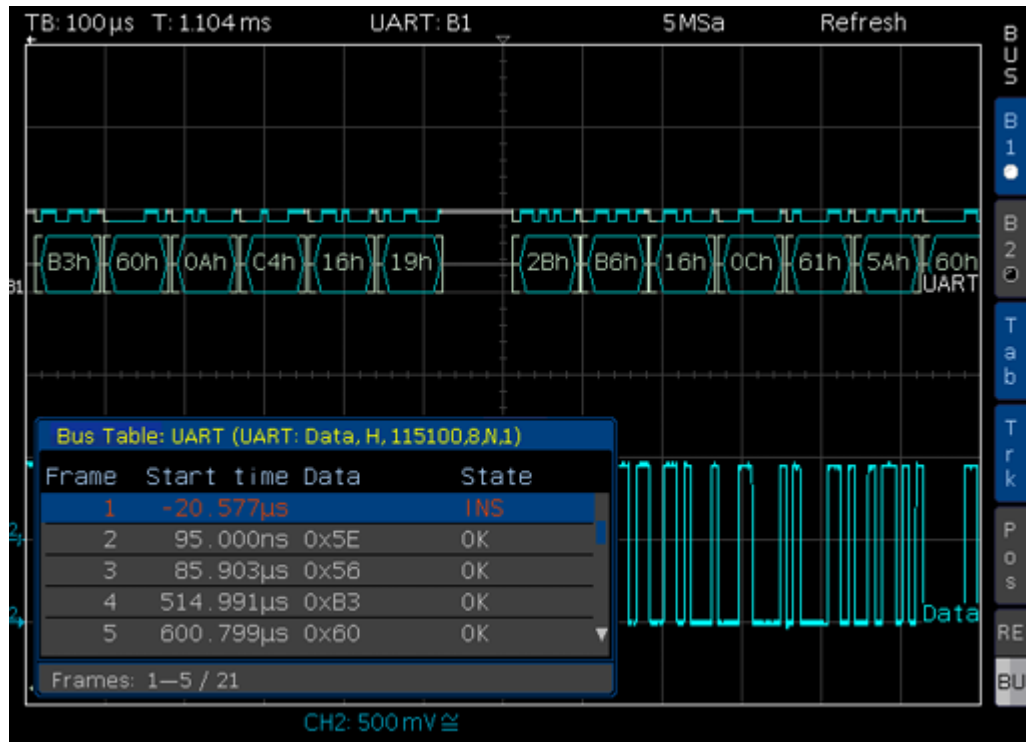

Figure 12-14: Example of an UART BUS table

Table 12-3: Content of the UART BUS table

Column	Description
"Start Time"	Time of frame start in relation to the trigger point
"Data"	Values of the data words
"State"	Frame Status: <ul style="list-style-type: none"> • "OK" = Frame is valid • "DATA" = during acquisition start/end only the frame start / frame end has been decoded; currently no data available • "INS" = the frame is not contained in the acquisition; the acquired part of the frame is valid.

12.6 CAN Bus (Option R&S RTCK3)

For CAN BUS trigger and decoding, you need the R&S RTCK3 option.

The CAN bus (Controller Area Network) is a bus system primarily developed for automotive applications and is used for the data exchange between controller units and sensors. It can be found in aviation, healthcare, and general automation industries.

At the physical level, CAN is a differential signal, therefore a differential probe is recommended for decoding. Nevertheless, standard probes are also suitable to capture the signals. The standard data rates range between 10 kBit/s and 1 MBit/s.

A CAN message primarily consists of a start bit, the frame ID (11 bit or 29 bit), the data length code DLC, the data, a CRC, acknowledge bit, and an end bit.

12.6.1 CAN Bus Configuration



Before you configure the bus, set the correct logic level (threshold).

- For analog channels, see "[THRESHOLD menu](#)" on page 37.
- For digital channels, see "[To set the threshold for logic states](#)" on page 109. The default value is 500 mV.

To select the CAN bus

1. Press the [BUS] key in the Vertical section.
2. In the short menu, select the bus: "B1" or "B2".
3. In the "BUS" menu, press the "BUS TYPE" softkey.
4. Use the [Universal] knob to select "CAN":

To configure the CAN bus

1. In the "BUS" menu, press "CONFIGURATION".
2. Configure the bus. The settings are described below.

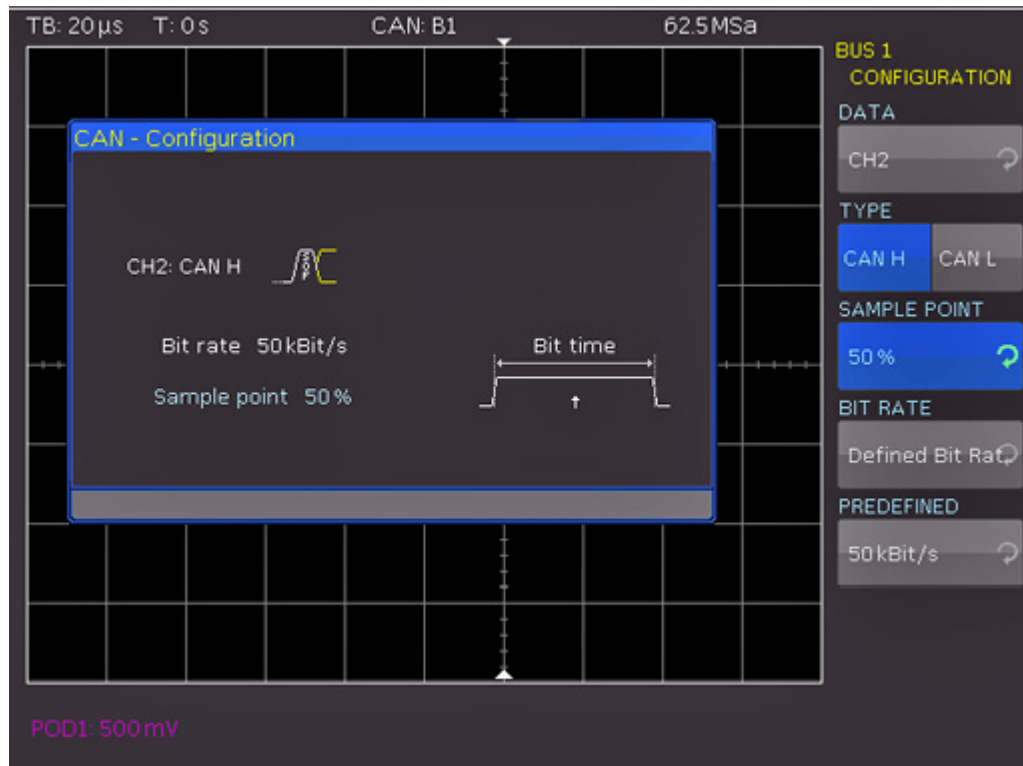

Figure 12-15: CAN bus configuration

DATA

Selects the channel of the data line.

TYPE

Selects the CAN-High or CAN-Low line. CAN uses both lines for differential signal transmission.

When using a differential probe, select "CAN H" if the positive input of the probe is connected to CAN-High and the negative input to CAN Low. If the probe is connected with reversed polarity, select "CAN L".

SAMPLE POINT

Sets the position of the sample point within the bit in percent of the nominal bit time. You can select a value between 25% and 90%.

BIT RATE, USER

The bit rate defines how many bits are sent per second. To select a standard bit rate, use "BIT RATE". To define a customized rate, use "USER".

12.6.2 CAN Bus Triggering

After the bus configuration is completed, you can trigger on various events.

To trigger on events

1. In the Trigger section, press the [TYPE] key.
2. Select "SERIAL BUS".
3. Press the [SOURCE] key in the Trigger section.
4. Choose "CAN" by pressing the respective softkey.
The bus is only available if it is configured correctly.
5. Press the [FILTER] key in the Trigger section to list the trigger conditions of the bus.
6. Configure the trigger condition. Possible conditions are described below.
7. Press the Back softkey until all menus are closed.
The oscilloscope triggers on the condition. For measurements without measuring object, refer to chapter [Chapter 11.2.5, "Serial Buses"](#), on page 119.

START OF FRAME

Triggers on the first slope of the SOF bit (synchronizing bit).

END OF FRAME

Triggers on the end of the frame.

FRAME

Triggers on the selected frame type. For data and remote frames, also select the identifier type (11 bit, 29 bit or any).

"ERROR"	Triggers on general frame error.
"OVERLOAD"	Triggers on CAN overload frames.
"DATA"	Triggers on data frames.
"REMOTE"	Triggers on remote frames.
"DATA OR REMOTE"	Triggers on either data frames or remote frames.

ERROR

Identifies various errors in a frame. Select one or several error message types as trigger condition.

"STUFF BIT"	Frame segments (e.g. frame start) are coded during the bit stuffing procedure. The transmitter automatically adds a complimentary bit to the bit stream if it detects 5 consecutive bits with identical value in the bit stream. An error occurs if the 6th identical bit level is detected in the specified sections.
"FORM"	A form error occurs if a fixed-form bit field contains one or more invalid bits.
"ACKNOWLEDGE"	An authentication error occurs if the transmitter receives no acknowledgment - a dominant bit during the Ack Slot.

"CRC" CAN uses a complex checksum calculation called Cyclic Redundancy Check. The transmitter calculates the CRC and transmits the result in a CRC sequence. The receiver calculates the CRC in the same way. A CRC error occurs if the calculated result differs from the received CRC sequence.

IDENTIFIER

Triggers on an address or address range. Configure the following:

- "FRAME TYPE" on page 146
- "IDENTIFIER SETUP" on page 146

IDENTIFIER AND DATA

Triggers on a combination of identifier and data pattern. Configure the following:

- "FRAME TYPE" on page 146
- "IDENTIFIER SETUP" on page 146
- "DATA SETUP" on page 146

FRAME TYPE

Selects the frame type: remote or data frame, or both.

IDENTIFIER SETUP

Defines the address of the data pattern:

- "ID TYPE", the length of the identifier (11 bit for CAN base frame format, or 29 bit for extended CAN frames).
- Compare function: "COMPARE" on page 146.
- Address pattern: "PATTERN INPUT" on page 130.

DATA SETUP

Specify the data pattern for up to 8 bytes.

- "DATA LENGTH", the number of data bytes to be compared.
- "COMPARE" on page 146 function.
- Data pattern: "PATTERN INPUT" on page 130.

COMPARE

Defines the comparison function for data and address patterns. If the pattern includes at least one X (do not care), you can trigger on a value equal or not equal to the specified value. If the pattern includes only 0 or 1, you can trigger on an area greater than or less than the specified value.

12.6.3 CAN Decode Results

Certain portions of the CAN messages are displayed in color to recognize the different elements:

- White: Data length code, number of data bytes
- Cyan: Data words
- Magenta: Identifier
- Red: Frame error

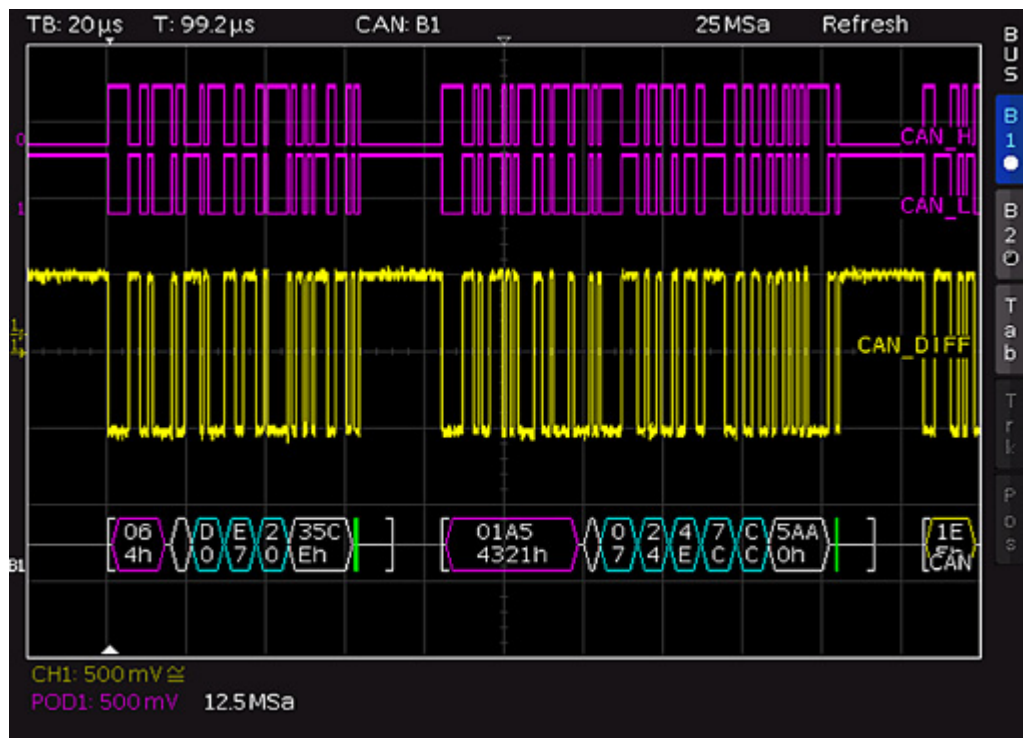

Figure 12-16: Decoded CAN bus



Figure 12-17: Example of a CAN bus table

Table 12-4: Content of the CAN bus table

Column	Description
"Start Time"	Time of frame start in relation to the trigger point
"Type"	Frame type: <ul style="list-style-type: none"> • "DATA" = Data frame • "REMOTE" = Remote frame • "ERR-F." = Transmission error (error frame) • "OVL-F." = Overload frame
"ID"	Frame ID
"DLC"	Data length code, number of data bytes
"Data"	Values of the data bytes
"CRC"	Cyclic Redundancy Check
"State"	Frame state: <ul style="list-style-type: none"> • "OK" = frame is valid • "CRC" = the calculated result deviates from the received CRC sequence (cyclic redundancy check failed) • "NACK" = no acknowledge • "CRC+NACK" = cyclic redundancy check failed followed by "not acknowledge" • "STUFF" = Bit stuffing error • "INS" = the frame is not contained in the acquisition; the acquired part of the frame is valid.

12.7 LIN Bus (Option R&S RTCK3)

For CAN bus trigger and decoding, you need the R&S RTCK3 option.

The LIN bus (Local Interconnect Network) is a simple master/slave bus system for automotive applications and is used for the data exchange between controller units and sensors or actuators. The signal is transmitted on one line with ground reference to the vehicle mass.

A LIN bus has the following properties:

- Serial single-wire communication protocol (byte-oriented)
- Master-slave communication (up to 12 knots)
- Master-controlled communication (master initiates / coordinates communication)

The data is transmitted in bytes without parity (based on UART). Each byte consists of a start bit, 8 data bits, and a stop bit.

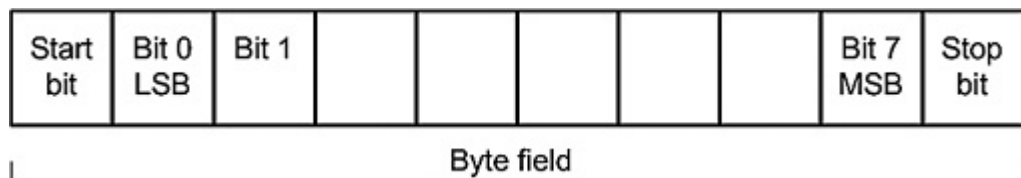

Figure 12-18: LIN byte structure

12.7.1 LIN Bus Configuration



Before you configure the bus, set the correct logic level (threshold).

- For analog channels, see "[THRESHOLD menu](#)" on page 37.
- For digital channels, see "[To set the threshold for logic states](#)" on page 109. The default value is 500 mV.

To select the LIN bus

1. Press the [BUS] key in the Vertical section.
2. In the short menu, select the bus: "B1" or "B2".
3. In the "BUS" menu, press the "BUS TYPE" softkey.
4. Use the [Universal] knob to select "LIN":

To configure the CAN bus

1. In the "BUS" menu, press "CONFIGURATION".
2. Configure the bus. The settings are described below.

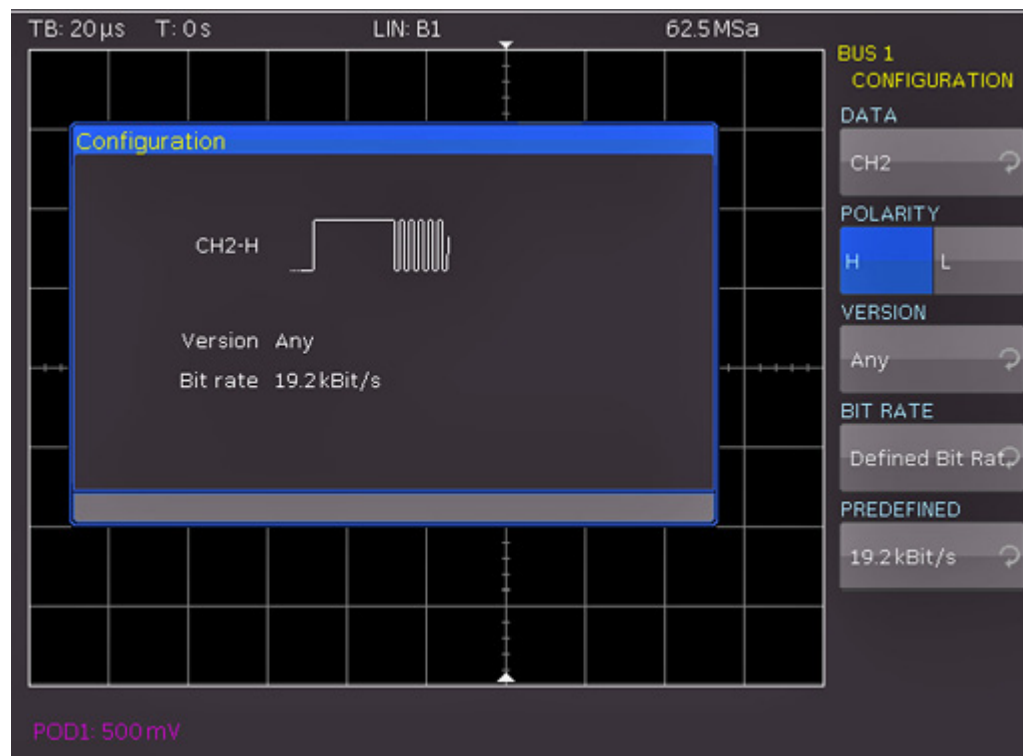

Figure 12-19: LIN bus configuration

DATA

Selects the channel of the data line.

POLARITY

Defines the idle state of the bus. The idle state is the recessive state and corresponds to a logic 1.

VERSION

Select the version of the LIN standard (version 1x, version 2x, J2602 or any).

BIT RATE

Specifies the number of transmitted bits per second.

USER

Changes a selected standard data rate. The highest possible data rate is 4 MBit/s. Use the universal knob or the [KEYPAD] to adjust the value.

12.7.2 LIN Bus Triggering

After the bus configuration is completed, you can trigger on various events.

To trigger on events

1. In the Trigger section, press the [TYPE] key.
2. Select "SERIAL BUS".
3. Press the [SOURCE] key in the Trigger section.
4. Choose "LIN" by pressing the respective softkey.
The bus is only available if it is configured correctly.
5. Press the [FILTER] key in the Trigger section to list the trigger conditions of the bus.
6. Configure the trigger condition. Possible conditions are described below.
7. Press the Back softkey until all menus are closed.
The oscilloscope triggers on the condition. For measurements without measuring object, refer to chapter [Chapter 11.2.5, "Serial Buses"](#), on page 119.

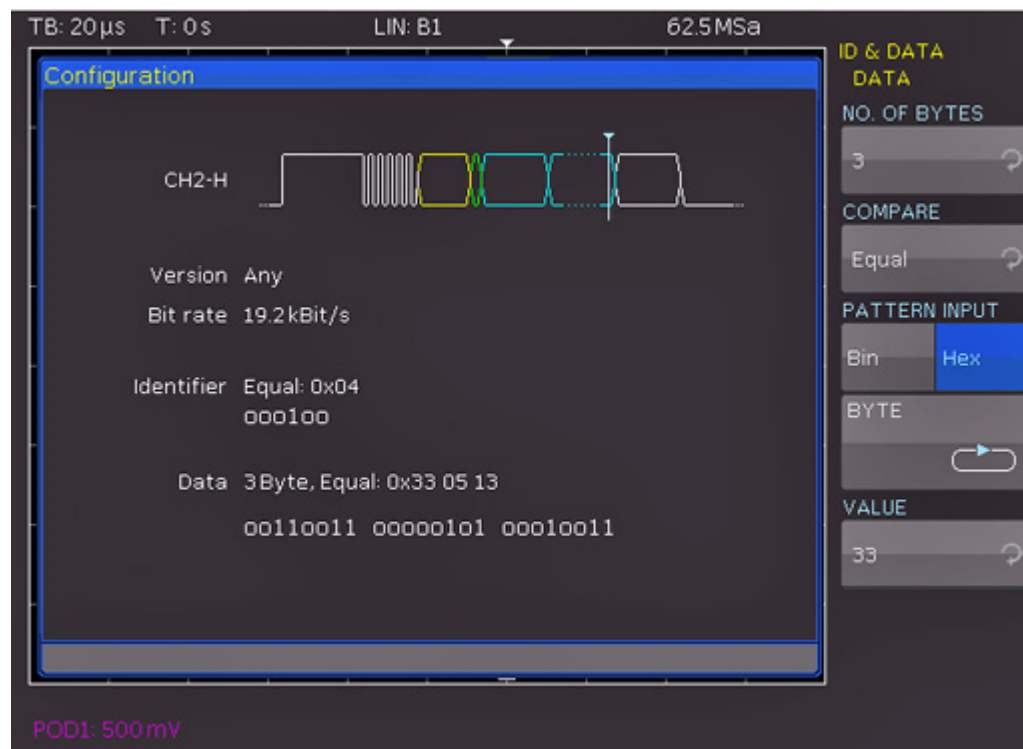

Figure 12-20: LIN data trigger menu

START OF FRAME

Triggers on the stop bit of the synchronizing field.

WAKE UP

Triggers after a wake-up frame.

ERROR

Identifies various errors in a frame. Select one or more error types as trigger condition.

- | | |
|-----------------------|---|
| "CRC" | LIN uses a complex checksum calculation (Cyclic Redundancy Check). The transmitter calculates the CRC and transmits the result in a CRC sequence. The receiver calculates the CRC in the same way. An error occurs if the calculated result differs from the received CRC sequence. |
| "PARITY" | Triggers on a parity error. Parity bits are bit 6 and bit 7 of the identifier. The correct transfer of the identifier is verified. |
| "SYNCHRONIZ-
NIZ." | Triggers if the synchronizing field indicates an error. |

IDENTIFIER

Triggers on an identifier or identifier range. Configure the following:

- Compare function: **"COMPARE"** on page 152.
- Identifier pattern: **"PATTERN INPUT"** on page 130.

IDENTIFIER AND DATA

You define the "IDENTIFIER SETUP" in the same way as for the identifier trigger ("COMPARE" and "PATTERN INPUT").

In addition, define the "DATA SETUP" to specify the data bit pattern or HEX values for up to 8 bytes.

Triggers on a combination of identifier and data condition:

- Identifier setup: "IDENTIFIER" on page 151
- "DATA SETUP" on page 152

DATA SETUP

Specify the data pattern for up to 8 bytes.

- "NO. OF BYTES", the number of data bytes to be compared.
- Compare function: "COMPARE" on page 152.
- Data pattern: "PATTERN INPUT" on page 130.

COMPARE

Defines the comparison function. If the pattern includes at least one X (do not care), it is possible to trigger on a value equal or not equal to the specified value. If the pattern includes only 0 or 1, it is possible to trigger on an area greater than or less than the specified value.

12.7.3 LIN Decode Results

Certain portions of the messages are displayed in color to identify the different elements:

- White: Synchronization byte / correct checksum
- Cyan: Data words
- Yellow: Identifier
- Green: Parity bit
- Red: Frame error

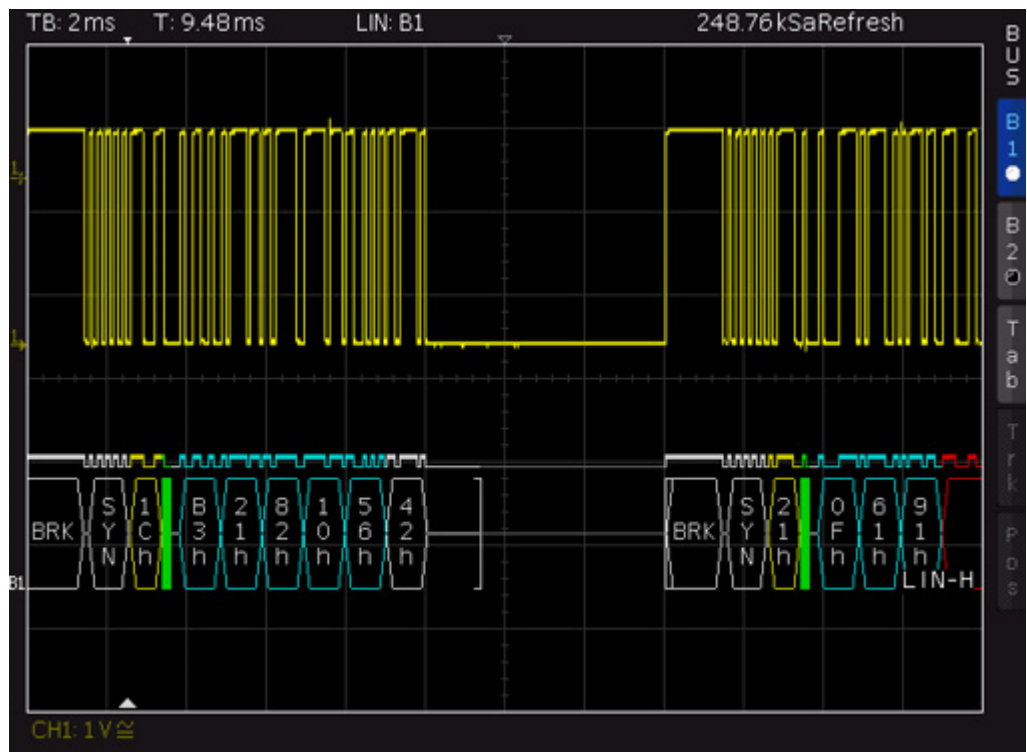

Figure 12-21: LIN bus

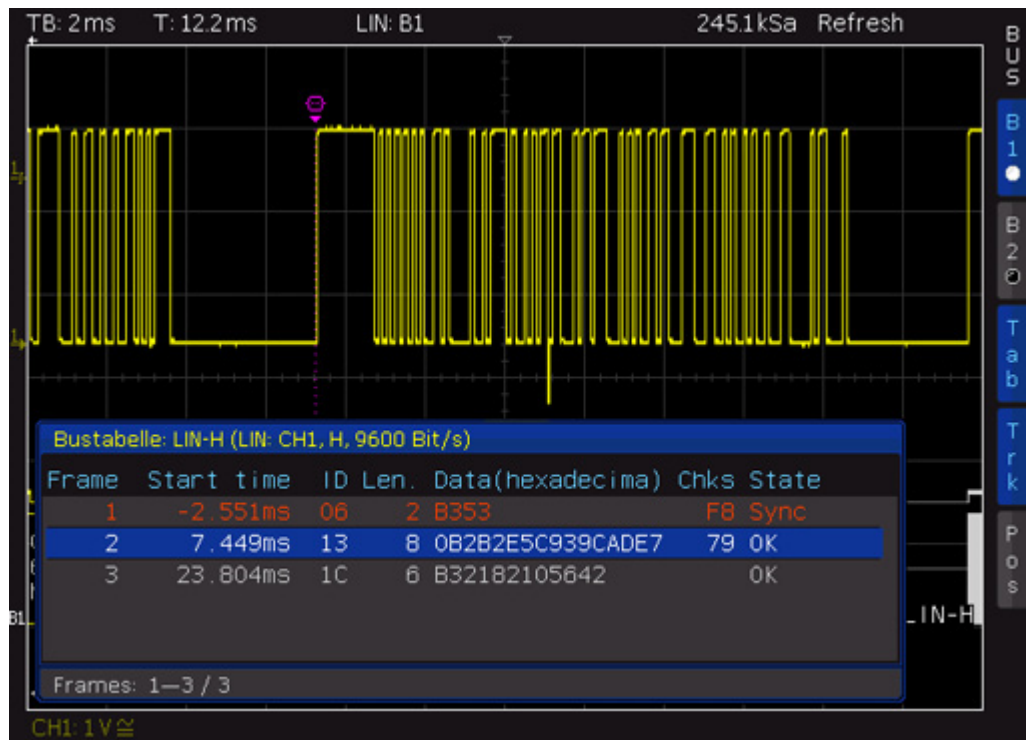

Figure 12-22: Example of a LIN bus table

Column	Description
"Start Time"	Time of frame start in relation to the trigger point
"ID"	Frame identifier
"Length"	Number of data bytes
"Data"	Values of the data bytes
"Chks"	Checksum value
"State"	Frame state: <ul style="list-style-type: none">• "OK" = Frame is valid• "DATA" = during acquisition start/end only the frame start / frame end has been decoded; currently no data available• "SYNC" = Synchronization error• "CHKS" = Checksum error• "PARI" = Parity error• "WAKEUP" = Wakeup frame• "INS" = the last frame is not contained in the acquisition. The frame end was not decoded.

13 Network Connections and Remote Operation

The R&S RTC1000 has a LAN interface and a USB type B port for remote control and remote operation.

13.1 LAN Connection

A LAN connection is necessary for remote control of the instrument, and for access from a computer using a web browser. You can connect the instrument to a local area network (LAN), usually the company network, or directly to a computer. To identify the instrument in the network, you need the IP address of the R&S RTC1000.

The network card can be operated with a 10 Mbps Ethernet IEEE 802.3 or a 100 Mbps Ethernet IEEE 802.3u interface. To establish a network connection, connect a commercial RJ-45 cable to one of the LAN ports of the instrument and to a PC.

Depending on the network capacities, the TCP/IP address of the instrument can be obtained in different ways:

- Automatically using DHCP. All address information is assigned automatically. Automatic private IP addressing (APIPA) is not supported.
- Manually: the address must be set manually.

By default, the instrument is configured to use automatic configuration and obtain all address information automatically. Thus, it is safe to establish a physical connection to the LAN without any previous instrument configuration.

NOTICE

Risk of network errors

Connection errors can affect the entire network. If your network does not support DHCP, or if you choose to disable dynamic TCP/IP configuration, you must assign valid address information before connecting the instrument to the LAN. Contact your network administrator to obtain a valid IP address.

Connect computer and instrument to the same network. Otherwise a remote connection is not possible.

If DHCP is set and the system cannot assign an IP address to the R&S RTC1000, it can take a while until you can reconfigure the interface. Possible reasons are: no Ethernet cable is connected, or the network does not support DHCP.

Connecting the instrument to the LAN

1. Connect the LAN cable to the LAN connector at the rear panel of the instrument, and to the LAN connector of the network or computer.
2. Press the [SETUP] key.

3. Press the "INTERFACE" softkey.
4. To activate the LAN interface, press "ETHERNET".
5. Press "PARAMETER".

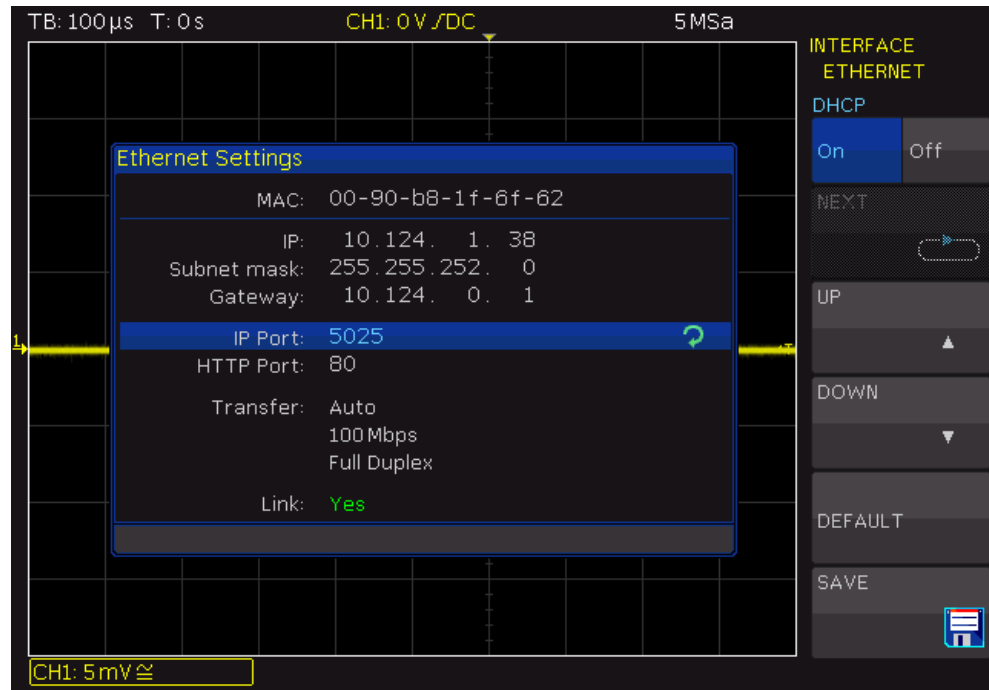

Figure 13-1: Ethernet settings

The MAC address (physical address) and the "Link" status information is displayed for information only and cannot be edited. The IP address can be changed if DHCP is off.

6. Switch DHCP on or off:
 - "On" enables DHCP for automatic network parameter distribution and shows the values of these parameters. Note that refreshing the values (for example after disconnecting the LAN cable and reconnecting it) can take a while, depending on the network responsiveness.
 - "Off": Use this setting if the network does not support dynamic host configuration protocol (DHCP).
7. If DHCP is off, define the IP address of the instrument. Set up each address block individually:
 - a) Select "IP" by pressing "Up" or "Down".
 - b) Define the first block number using the [Universal] knob.
 - c) Press "Next" to move to the next block.
 - d) Define the number of the second block.
 - e) Repeat steps c) and d) for the remaining blocks.
 - f) When the IP address is complete, press "Down" to continue with the next setting.

8. Define the "Subnetmask" and "Gateway" in the same way.
9. Select the "IP Port", the port number for SCPI socket communication. The default port number for SCPI socket communication is 5025.
10. Select the "HTTP Port" used by the instrument.
11. Select the "Transfer" mode. The mode can either be determined automatically ("Auto"), or you can select a combination of a transfer rate and half or full duplex manually.
12. Press "SAVE" to save the LAN parameters.

The "Link" information at the bottom of the dialog box indicates whether a LAN connection was established successfully.

Check the LAN connection using the ping command in a command window on the computer: `ping <IP address>`.

Using the IP address in remote control

The IP address of the instrument is part of the resource string to identify and control the instrument. The resource string has the form:

```
TCPIP::<IP_address>::<IP_port>::SOCKET
```

The VISA resource string of the instrument is shown in the [SETUP] > "DEVICE INFORMATION" window.

Example:

If the instrument has the IP address 192.1.2.3; the valid resource string is:
TCPIP::192.1.2.3::5025::SOCKET

If the LAN is supported by a DNS server, the host name can be used instead of the IP address. The DNS server (Domain Name System server) translates the host name to the IP address. The resource string has the form:

```
TCPIP::<host_name>::<IP_port>::SOCKET
```

To assign a host name to the R&S RTC1000, select [SETUP] key > "Page 2|3" > "DEVICE NAME".

Example:

If the host name is TEST1; the valid resource string is:
TCPIP::TEST1::5025::SOCKET

The end character must be set to linefeed (LF).

13.2 Remote Access Using a Web Browser

The R&S RTC1000 firmware contains a web server. If a LAN connection is established, you can access the instrument remotely using a web browser on the control computer.

The browser access allows you to:

- Check instrument data
- Control the instrument remotely
- Print screenshots
- Send remote commands
- Save waveform and instrument data
- Check network settings

13.2.1 Accessing the Instrument Using a Web Browser

To access the R&S RTC1000, you need a LAN connection and the IP address of the instrument.

1. Set up a LAN connection, see "[Connecting the instrument to the LAN](#)" on page 155.
2. Obtain the IP address of the R&S RTC1000: [SETUP] > "DEVICE INFORMATION".
3. Open an Internet browser on the control computer.
4. Enter the IP address of the R&S RTC1000 in the address line:
http://:xxx.yyy.zzz.xxx.

The "Instrument Home" page opens.

13.2.2 Instrument Home

The "Instrument Home" page provides information on the instrument and the LAN connection.

Instrument Home

Screenshot

SCPI Device Control

Save/Recall

Network Settings

[Print view](#)

Manufacturer:	Rohde&Schwarz	Ethernet Port	
Device Class:	Oscilloscope	MAC Address:	00-90-B8-1F-6F-62
Device Type:	RTC1002	DHCP:	On
Serial Number:	1335.7500k02/101131	IP Address:	10.124.1.38
Firmware Version:	06.020	Subnet Mask:	255.255.252.0
		Default Gateway:	10.124.0.1
		IP Port:	5025
		HTTP Port:	80
USB Port			
		Vendor ID:	0AAD (hex)
		Product ID:	0119 (hex)

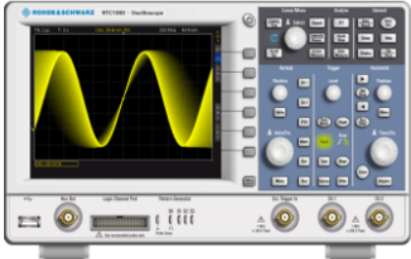

©2017 ROHDE&SCHWARZ. All rights reserved.

13.2.3 Screenshot

The "Screenshot" page shows a copy of the instrument's display. It also provides instrument control functions and screenshot settings.

Instrument control

- "Run" and "Stop" = start and stop continuous acquisition, same as [RUN/STOP] key on the instrument.
- "Single" = [SINGLE] key on the instrument
- "Autoset" = [AUTOSET] key on the instrument
- "Preset" = Press and hold the [AUTOSET] key on the instrument until you hear a beep.

Screenshot Print view 

Run Stop Single Autoset Preset

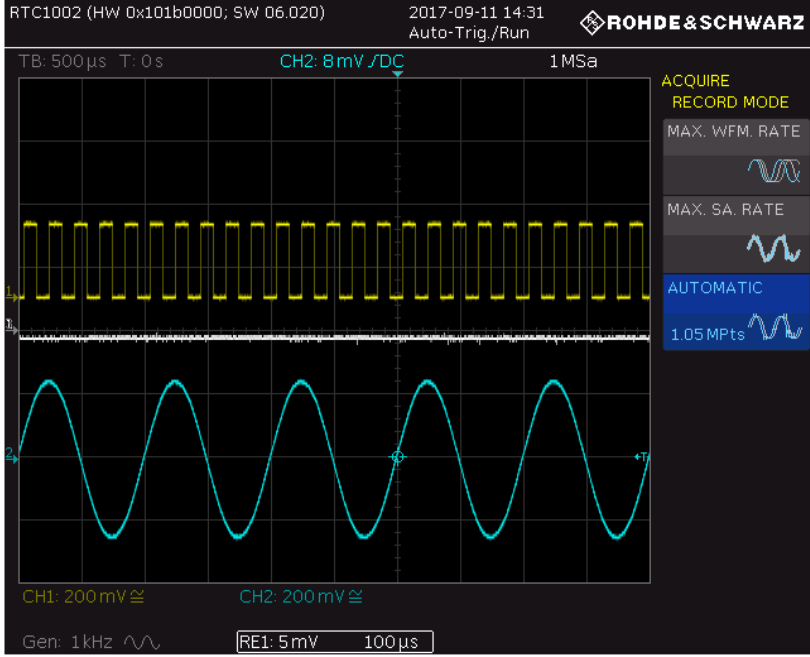

RTC1002 (HW 0x101b0000; SW 06.020) 2017-09-11 14:31
Auto-Trig./Run

TB: 500 μ s T: 0s CH2: 8 mV /DC 1MSa

ACQUIRE RECORD MODE
MAX. WFM. RATE
MAX. SA. RATE
AUTOMATIC
1.05 MPts

CH1: 200 mV \cong CH2: 200 mV \cong
Gen: 1 kHz \sim RE1: 5 mV 100 μ s

Auto refresh: off Format: PNG Color mode: Color Update

©2017 ROHDE&SCHWARZ. All rights reserved.

Screenshots

- "Auto refresh" and "Update"
Get the current screen content from the instrument. With "Auto refresh", you can set the interval of automatic updates.
 - "Format" and "Color mode":
Set the file format and color mode of the screenshot.
- To save the screenshot, *right-click the picture* and select "Save image as".

13.2.4 SCPI Device Control

On the "SCPI Device Control" page, you can check how the transfer of remote commands is working.

You can enter a single command, for example; *IDN?, and transmit it with "Send". Do not press the [Enter] key.

If the sent command has an error, an error message is created in the background, and you do not get any response. You can see the error messages using "Last Error Message" and "All Error Messages"

SCPI Device Control

The device may be controlled with special commands (SCPI - Standard Commands for Programmable Instruments). Please take the respectively valid instruction set from the documentation delivered with the device. If you type a wrong command or use a wrong syntax, the device creates an error message which is not send immediately, complying with the standard, but can be requested separately. In this case you will **not** get a response. An easy way to request the error messages is to use the two buttons.

Command:

Response:
`Rohde&Schwarz,RTC1002,1335.7500k02/101131,06.020`

©2017 ROHDE&SCHWARZ. All rights reserved.

13.2.5 Save/Recall

On the "Save/Recall" page, you can save waveform data and instrument settings to a file - either on the computer (local file) or on the instrument (remote device). On the computer, the default storage directory is the download folder, but you can change the directory using the download functions of your browser. On the instrument, the files are saved in the internal storage.

You can also load reference waveforms and instrument settings from file to the instrument.

To save data to a file on the computer

1. Select the waveform or the device settings in the "Source" list.
2. Select the file "Format".

See also:

- [Chapter 9.3.1, "Waveform File Formats"](#), on page 102
- [Chapter 9.2, "Reference Waveforms"](#), on page 98

3. For analog and digital channels, select whether you want to read out the display memory ("Display Data") or the entire acquisition memory ("Acq. Memory").
4. Click "Save".

Instrument Home

Screenshot

SCPI Device Control

Save/Recall

Network Settings

Save/Recall

If you want to save a trace to a file, you first have to select the trace, format and points. The number of samples and the file size will be indicated below. To download the trace file, use the "Save" button.

Save to local file

Source: Format: Points:

Source: Channel1
 Samples: 6000
 File size (approx.): 141 kB
 Sample number may be reduced due to running acquisition.

Recall from local file (max. 256 kB)

Target: Source file:

Save to remote device

Source: Target file:

Recall from remote device

Target: Source file:

©2017 ROHDE&SCHWARZ. All rights reserved.

13.2.6 Network Settings

On the "Network Setting" page, you can change the port settings, switch off DHCP address and enter an IP address in a more comfortable way than directly on the instrument. To take effect of the changes, "Submit" them to the instrument.

"Reset" removes all modified values that were not yet sent to the instrument.

Instrument Home

Screenshot

SCPI Device Control

Save/Recall

Network Settings

Network Settings [Print view](#)

Warning: Changing the network settings may result in loss of connection!

DHCP: On Off

IP Address: . . .

Subnet Mask: . . .

Default Gateway: . . .

IP Port:

HTTP Port:

Transfer Mode:

©2017 ROHDE&SCHWARZ. All rights reserved.

13.3 USB Connection

In addition to a LAN connection, you can use the USB connector at the rear panel to access the instrument via USB.

Connecting the instrument using USB

1. Connect the USB cable to the USB type B connector at the rear panel of the instrument, and to the computer.
2. Press the [SETUP] key.
3. Press "INTERFACE".
4. Press "USB" to select USB connection.
5. Press "PARAMETER".

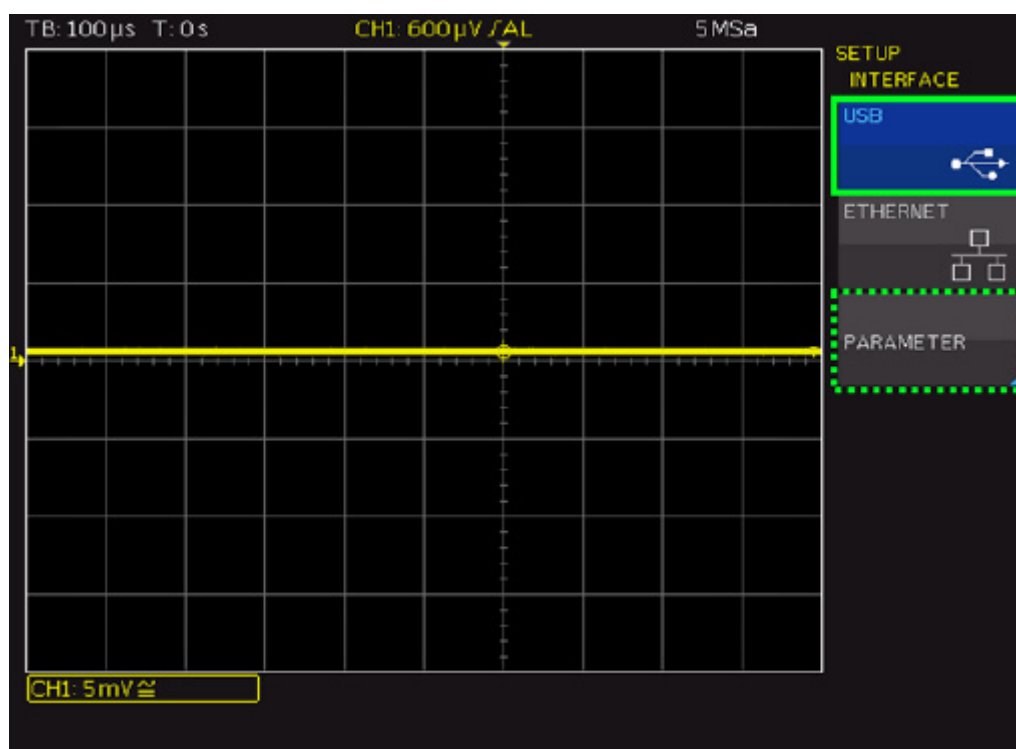

6. Select the USB mode:
 - USB TMC (Test & Measurement Class)
 - USB VCP (Virtual Com Port)
 - USB MTP (Media Transfer Protocol)

13.3.1 USB TMC

USB TMC means USB Test & Measurement Class. You can use this interface for remote control of the instrument using SCPI commands. USB TMC does not need a driver installation but requires a VISA installation on the controlling computer. VISA is used to access the instrument, to send remote commands, and to read status information.

Rohde & Schwarz provides the standardized I/O software library R&S VISA for communication via TCP/IP (LAN: HiSlip, VXI-11) or USB (USBTMC) interfaces. R&S VISA is available for download at the Rohde & Schwarz website www.rohde-schwarz.com/rsvisa.

13.3.2 USB VCP

USB VCP uses the virtual COM port (VCP) to communicate with the measuring instrument. You can use any terminal program to send SCPI commands. USB VCP requires a USB VCP driver on the controlling computer. If the computer requests a driver installation, you can download the driver at the Rohde & Schwarz website (www.rohde-schwarz.com/de/treiber/hmo/, HO732). You need administrator rights to install the driver.

13.3.3 USM MTP

USB MTP is the USB media transfer protocol. It is a solution to load data from the oscilloscope to the computer. Remote control using SCPI commands is not possible.

USB MTP does not need a driver installation. Connect a USB cable to the USB type B connector at the instrument and to the computer (USB type A). Select USB MTP as interface, and you can access the oscilloscope data from the computer. You see the oscilloscope in the computer's Device Manager and in the file explorer as portable instrument.

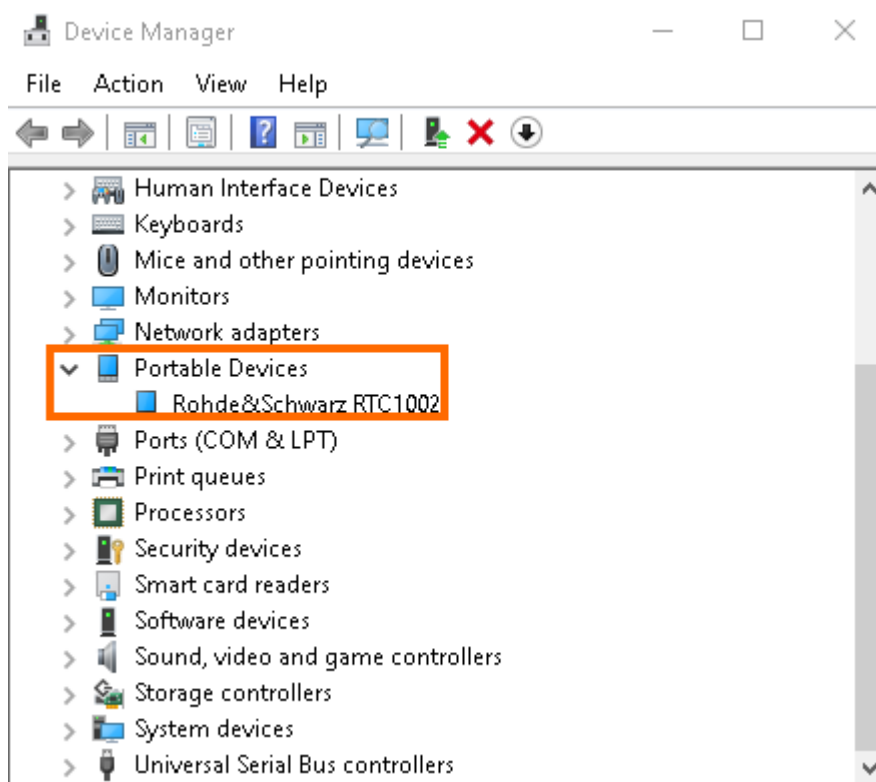

Figure 13-2: R&S RTC1000 in the Device Manager of the computer

The following instrument folders are visible:

- **Internal Storage:**
Read-only folder, provides access to the files stored on the instrument, for example, instrument settings, references, and formula sets.
- **Live Data:**
Read-only folder, provides access to multiple subfolders and current instrument data. Files are created on demand. See "[Live Data](#)" on page 166.
- **Upload:**
Read-write folder to send instrument settings files, firmware update files, and license key files to the oscilloscope. The content is deleted when you turn off or restart the instrument. The oscilloscope checks the data and loads it automatically if possible. The firmware update must be started manually.
- **USB Front**
If a USB flash drive is connected to the oscilloscope, an additional `USB Front` folder is available. You can view the files and copy files to and from the computer to the USB flash drive. The indicated file size is the actual file size.

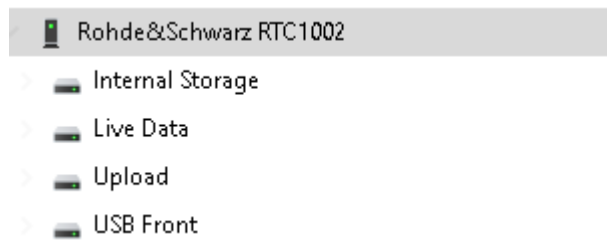

Figure 13-3: Folders in the file explorer, with USB flash drive

Live Data

The `Live Data` folder contains several subfolders and files:

- `Screenshot.*`
The screenshot is created when you open the file. To open it, right-click the file and select "Open". Double-clicking the file can cause an error because the indicated file size is an estimation and can differ from the actual file size.
- `SETTINGS.*`
Contain the current instrument settings.
- `Channel, Bus and POD`
Contain two subfolders and a `README.TXT`. The files in the `Acquisition Memory` folder provide data from the acquisition memory, and the files in the `DISPLAY DATA` folder provide the visible waveform data in various formats. The file content is generated when the file transfer to the PC is started.
- `Math and Reference`
Contain visible waveform data. The `INFO.TXT` file provides information on the waveforms, such as name, units, samples. The file content is generated when the file transfer to the PC is started.

To get accurate waveform data and to read the acquisition memory, make sure to stop the acquisition before you access the files. If acquisition is running, reading the data results in waveform data from different acquisitions, and the acquisition memory cannot be read.

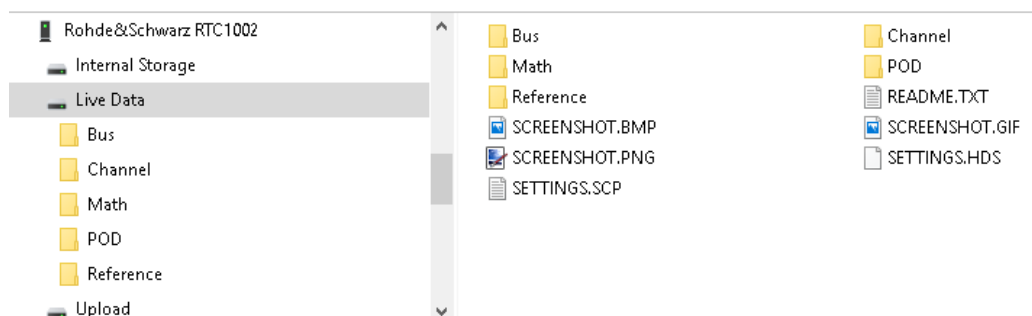

Figure 13-4: Folder structure of Live Data folder

13.4 Switching to Remote Control

When you switch on the instrument, it is always in manual operation state („local“ state) and can be operated using the front panel. When you send a command from the control computer, it is received and executed by the instrument. The display remains on, manual operation is always possible.

14 Remote Commands Reference

This chapter provides the description of all remote commands available for the R&S RTC1000. The commands are sorted according to the menu structure of the instrument. A list of commands in alphabetical order is given in the „List of Commands“ at the end of this chapter.

General information on remote control is given in the "Annex" of this manual.

14.1 Conventions Used in Remote Command Description

Note the following conventions used in the remote command descriptions:

- **Command usage**
If not specified otherwise, commands can be used both for setting and for querying parameters.
If a command can be used for setting or querying only, or if it initiates an event, the usage is stated explicitly.
- **Parameter usage**
If not specified otherwise, a parameter can be used to set a value and it is the result of a query.
Parameters required only for setting are indicated as **Setting parameters**.
Parameters required only to refine a query are indicated as **Query parameters**.
Parameters that are only returned as the result of a query are indicated as **Return values**.
- **Conformity**
Commands that are taken from the SCPI standard are indicated as **SCPI confirmed**. All commands used by the R&S RTC1000 follow the SCPI syntax rules.
- **Asynchronous commands**
A command which does not automatically finish executing before the next command starts executing (overlapping command) is indicated as an **Asynchronous command**.
- **Reset values (*RST)**
Default parameter values that are used directly after resetting the instrument (*RST command) are indicated as ***RST** values, if available.
- **Default unit**
The default unit is used for numeric values if no other unit is provided with the parameter.

14.2 Common Commands

Common commands are described in the IEEE 488.2 (IEC 625-2) standard. These commands have the same effect and are employed in the same way on different devices. The headers of these commands consist of "*" followed by three letters. Many common commands are related to the Status Reporting System.

Available common commands:

*CAL?	169
*CLS	169
*ESE	169
*ESR?	169
*IDN?	170
*OPC	170
*OPT?	170
*PSC	170
*RST	171
*SRE	171
*STB?	171
*TRG	171
*TST?	172
*WAI	172

*CAL?

Performs a self-alignment of the instrument and then generates a status response. Return values $\neq 0$ indicate an error.

Usage: Query only

*CLS

Clear status

Sets the status byte (STB), the standard event register (ESR) and the `EVENT` part of the `QUESTIONABLE` and the `OPERATION` registers to zero. The command does not alter the mask and transition parts of the registers. It clears the output buffer.

Usage: Setting only

*ESE <Value>

Event status enable

Sets the event status enable register to the specified value. The query returns the contents of the event status enable register in decimal form.

Parameters:

<Value> Range: 0 to 255

*ESR?

Event status read

Returns the contents of the event status register in decimal form and then sets the register to zero.

Return values:

<Contents> Range: 0 to 255

Usage: Query only

***IDN?**

Identification

Returns the instrument identification.

Return values:

<ID> "Rohde&Schwarz,<device type>,<serial number>,<firmware version>"

Example: Rohde&Schwarz,RTC1002,1335.7500k02/120012,01.203

Usage: Query only

***OPC**

Operation complete

Sets bit 0 in the event status register when all preceding commands have been executed. This bit can be used to initiate a service request. The query writes a "1" into the output buffer when all preceding commands have been executed, which is useful for command synchronization.

***OPT?**

Option identification query

Queries the options included in the instrument. For a list of all available options and their description, refer to the data sheet.

Return values:

<Options> The query returns a list of options. The options are returned at fixed positions in a comma-separated string. A zero is returned for options that are not installed.

Usage: Query only

***PSC <Action>**

Power on status clear

Determines whether the contents of the `ENABLe` registers are preserved or reset when the instrument is switched on. Thus a service request can be triggered when the instrument is switched on, if the status registers ESE and SRE are suitably configured. The query reads out the contents of the "power-on-status-clear" flag.

Parameters:

<Action>	0 1
	0
	The contents of the status registers are preserved.
	1
	Resets the status registers.

***RST**

Reset

Sets the instrument to a defined default status. The default settings are indicated in the description of commands.

Usage: Setting only

***SRE <Contents>**

Service request enable

Sets the service request enable register to the indicated value. This command determines under which conditions a service request is triggered.

Parameters:

<Contents>	Contents of the service request enable register in decimal form. Bit 6 (MSS mask bit) is always 0.
	Range: 0 to 255

***STB?**

Status byte query

Reads the contents of the status byte in decimal form.

Usage: Query only

***TRG**

Trigger

Triggers all actions waiting for a trigger event. In particular, *TRG generates a manual trigger signal. This common command complements the commands of the `TRIGger` subsystem.

Usage: Event

***TST?**

Self-test query

Initiates self-tests of the instrument and returns an error code.

Return values:

<ErrorCode> **integer > 0 (in decimal format)**
 An error occurred.
 (For details, see the Service Manual supplied with the instrument).

0
 No errors occurred.

Usage: Query only

***WAI**

Wait to continue

Prevents servicing of the subsequent commands until all preceding commands have been executed and all signals have settled (see also command synchronization and [*OPC](#)).**Usage:** Event

14.3 Acquisition and Setup

- [Starting and Stopping Acquisition](#)..... 172
- [Time Base](#)..... 173
- [Acquisition](#)..... 175
- [Vertical](#)..... 180
- [Waveform Data](#)..... 184
- [Waveform Data Export to File](#)..... 191
- [Logic Channel](#)..... 192
- [Probes](#)..... 197

14.3.1 Starting and Stopping Acquisition

- [RUN](#)..... 172
- [RUNContinuous](#)..... 173
- [SINGle](#)..... 173
- [RUNSingle](#)..... 173
- [STOP](#)..... 173

RUN

Starts the continuous acquisition.

Usage: Event
Asynchronous command

RUNContinous

Same as RUN.

Usage: Event
Asynchronous command

SINGLE

Performs a single acquisition and returns to stop mode.

Usage: Event
Asynchronous command

RUNSingle

Same as SINGLE.

Usage: Event
Asynchronous command

STOP

Stops the running acquisition.

Usage: Event
Asynchronous command

14.3.2 Time Base

TIMebase:SCALe.....	173
TIMebase:RATime?.....	174
TIMebase:ACQTime.....	174
TIMebase:RANGe.....	174
TIMebase:DIVisions?.....	174
TIMebase:POSition.....	174
TIMebase:REFerence.....	175

TIMebase:SCALe <TimeScale>

Sets the horizontal scale for all channel and math waveforms.

Parameters:

<TimeScale> Range: 1e-9 to 50
 *RST: 100e-6
 Default unit: s/div

TIMEbase:RATime?

Queries the real acquisition time used in the hardware. If FFT analysis is performed, the value can differ from the adjusted acquisition time ([TIMEbase:ACQTime](#)).

Return values:

<HWAcqTime> Range: Depends on various settings
Default unit: s

Usage: Query only

TIMEbase:ACQTime <AcquisitionTime>

Defines the time of one acquisition, that is the time across the 12 divisions of the diagram: *Timebase Scale*12*.

Parameters:

<AcquisitionTime> Range: 12 ns to 600 s
Default unit: s

TIMEbase:RANGe <AcquisitionTime>

Defines the time of one acquisition, that is the time across the 12 divisions of the diagram: *Timebase Scale*12*.

Parameters:

<AcquisitionTime> Range: 12 ns to 600 s
Default unit: s

TIMEbase:DIVisions?

Queries the number of horizontal divisions on the screen.

Return values:

<HorizDivCount> Range: 12

Usage: Query only

TIMEbase:POStion <Offset>

Defines the trigger position (trigger offset) - the time interval between trigger point and reference point to analyze the signal some time before or after the trigger event. If the trigger position is zero, the trigger point matches the reference point.

See also: [TIMEbase:REFeRence](#)

Parameters:

<Offset> Range: -500 to 500
*RST: 0
Default unit: s

TIMEbase:REFerence <ReferencePoint>

Sets the reference point of the time scale (Time Reference) in % of the display. The reference point defines which part of the waveform is shown.

See also: [TIMEbase:POSition](#)

Parameters:

<ReferencePoint> Range: 10 to 90
 *RST: 50
 Default unit: %

14.3.3 Acquisition

AUToscale	175
ACQUIRE:MODE	175
ACQUIRE:INTERpolate	176
ACQUIRE:AVERAge:COUNT	176
ACQUIRE:AVERAge:COMPLETE?	176
ACQUIRE:WRATe	177
ACQUIRE:POINTS[:VALue]?	177
CHANnel<m>:TYPE	177
CHANnel<m>:ARITHmetics	178
TIMEbase:ROLL:ENABLE	178
ACQUIRE:FILTer:FREQUency	178
ACQUIRE:POINTS:ARATe?	179
ACQUIRE:SRATe?	179
ACQUIRE:STATE	179
ACQUIRE:TYPE	179
ACQUIRE:PEAKdetect	180
ACQUIRE:HRESolution	180

AUToscale

Performs an autoset process: analyzes the enabled channel signals, and obtains appropriate horizontal, vertical, and trigger settings to display stable waveforms.

Usage: Event
 Asynchronous command

ACQUIRE:MODE <AcquisitionMode>

Selects the method of adding waveform points to the samples of the ADC in order to fill the record length.

Parameters:

<AcquisitionMode> RTIME | ETIME

RTIME (Real Time Mode)

At slow time base settings the sampled points of the input signal are used to build the waveform, no waveform points are added. With fast time base settings, the sample rate is higher than the ADC sample rate. Waveform samples are added to the ADC samples with $\sin(x)/x$ interpolation.

ETIME (Equivalent time)

The waveform points are taken from several acquisitions of a repetitive signal at a different time in relation to the trigger point.

*RST: RTIM

ACQUIRE:INTERpolate <Interpolation>

Defines the interpolation mode.

Parameters:

<Interpolation> LINear | SINX | SMHD

LINear

Linear interpolation between two adjacent sample points.

SINX

Interpolation by means of a $\sin(x)/x$ curve.

SMHD

Sample & Hold causes a histogram-like interpolation.

*RST: SINX

ACQUIRE:AVERAGE:COUNT <AverageCount>

Defines the number of waveforms used to calculate the average waveform. The higher the number, the better the noise is reduced.

Parameters:

<AverageCount> Only numbers from the 2^n progression are permitted (2, 4, 8, ...)

Range: 2 to 1024

*RST: 2

ACQUIRE:AVERAGE:COMPLETE?

Returns the state of averaging.

Return values:

<AverageComplete> 0 | 1

0

The number of acquired waveforms is less than the number required for average calculation. See [ACQUIRE:AVERAGE:COUNT](#).

1

The instrument acquired a sufficient number of waveforms to determine the average.

Usage: Query only

ACQUIRE:WRATE <WaveformRate>

Defines the mode to set the sample rate (samples per second saved in the memory) and the waveform acquisition rate (waveforms per second).

Parameters:

<WaveformRate> AUTO | MWAVEform | MSAMples

AUTO

To display the best waveform, the instrument selects the optimum combination of waveform acquisition rate and sample rate using the full memory depth (maximum record length).

MWAVEform

Maximum waveform rate: The instrument combines sample rate and memory depth to acquire at maximum waveform acquisition rate. In connection with persistence, the mode can display rare signal anomalies.

MSAMples

Maximum sample rate: The instrument acquires the signal at maximum sample rate and uses the full memory depth. The result is a waveform with maximum number of waveform samples, high degree of accuracy, and low risk of aliasing.

*RST: AUTO

ACQUIRE:POINTS[:VALUE]?

The query returns the record length, the number of recorded waveform points.

Return values:

<RecordLength> Record length in Sa
*RST: 960000

Usage: Query only

CHANNEL<m>:TYPE <DecimationMode>

Selects the method to reduce the data stream of the ADC to a stream of waveform points with lower sample rate.

Suffix:

<m> The command affects all channels regardless of the indicated channel number. The suffix can be omitted.

Parameters:

<DecimationMode> SAMPLE | PDETECT | HRESOLUTION

SAMPLE

Input data is acquired with a sample rate which is aligned to the time base (horizontal scale) and the record length.

PDETECT (Peak Detect)

The minimum and the maximum of n samples in a sample interval are recorded as waveform points.

HRESOLUTION (High Resolution)

The average of n sample points is recorded as waveform point.

*RST: SAMPLE

CHANnel<m>:ARITHmetics <TrArithmetic>

Selects the method to build the resulting waveform from several consecutive acquisitions of the signal.

Suffix:

<m>

The command affects all channels regardless of the indicated channel number. The suffix can be omitted.

Parameters:

<TrArithmetic>

OFF | ENVELOPE | AVERAGE | FILTER

OFF

The data of the current acquisition is recorded according to the decimation settings.

ENVELOPE

Detects the minimum and maximum values in an sample interval over a number of acquisitions.

AVERAGE

Calculates the average from the data of the current acquisition and a number of acquisitions before. The number of used acquisitions is set with [ACQUIRE:AVERAGE:COUNT](#).

FILTER

Sets a low-pass filter with 3 dB attenuation at a configurable limit frequency set with [ACQUIRE:FILTER:FREQUENCY](#). The filter removes higher frequencies from the channel signals.

*RST: OFF

TIMEbase:ROLL:ENABLE <Roll>

Enables the roll mode.

Parameters:

<Roll>

ON | OFF

*RST: OFF

ACQUIRE:FILTER:FREQUENCY <FilterFrequency>

Sets the limit frequency if [CHANnel<m>:ARITHmetics](#) is set to [FILTER](#).

Parameters:

<FilterFrequency> Limit frequency with 3 dB attenuation.
Default unit: Hz

ACQUIRE:POINTS:ARATE?

Retrieves the sample rate of the ADC, that is the number of points that are sampled by the ADC in one second.

Return values:

<AcquisitionRate> ADC sample rate in Hz.

Usage: Query only

ACQUIRE:SRATE?

Returns the sample rate, that is the number of recorded waveform samples per second.

Return values:

<SampleRate> Waveform samples per second (Sa/s)

Usage: Query only

ACQUIRE:STATE <Acquisition State>

Sets or queries the acquisition state of the instrument.

Parameters:

<Acquisition State> RUN | STOP | COMPLETE | BREAK

RUN

Set: Starts the acquisition.

Read: The acquisition is running.

STOP

Set: Stops the acquisition when it is finished.

Read: Acquisition is stopped.

COMPLETE

Set: Not available.

Read: The current acquisition is finished and completed.

BREAK

Set: Immediate interrupt of current acquisition.

Read: acquisition is finished but interrupted.

*RST: RUN

ACQUIRE:TYPE <Acquisition Type>

Sets the type of the acquisition mode.

Parameters:

<Acquisition Type> REFRESH | SMOOTH | AVERAGE | ENVELOPE | FILTER

REFresh

The acquisitions are displayed as they are done.

SMOoth

Calculates a mean value of several adjacent sample points. Thus, smoothing is a moving average that uses the full data and can be used for non-periodic signals. It works like a low-pass, and increases the vertical resolution at the expense of bandwidth reduction.

AVERage

The acquisitions are averaged.

Detects the minimum and maximum values in an sample interval over a number of acquisitions, and displays the envelope waveforms.

FILTer

Sets a low-pass filter with 3 dB attenuation at a configurable limit frequency

*RST: OFF

ACQUIRE:PEAKdetect <PeakDetect>

Enables the peak detection.

Parameters:

<PeakDetect> AUTO | OFF
*RST: OFF

ACQUIRE:HRESolution <HighRes>

Enables the high resolution mode.

Parameters:

<HighRes> AUTO | OFF
*RST: OFF

14.3.4 Vertical

CHANnel<m>:STATe.....	181
CHANnel<m>:COUPling.....	181
CHANnel<m>:SCALe.....	181
CHANnel<m>:RANGe.....	181
CHANnel<m>:POSition.....	182
CHANnel<m>:OFFSet.....	182
CHANnel<m>:BANDwidth.....	182
CHANnel<m>:POLarity.....	182
CHANnel<m>:OVERload.....	183
CHANnel<m>:SKEW.....	183
CHANnel<m>:THReshold.....	183

CHANnel<m>:THReshold:FINdLevel.....	184
CHANnel<m>:THReshold:HYSTeresis.....	184
CHANnel<m>:LABel.....	184
CHANnel<m>:LABel:STATe.....	184

CHANnel<m>:STATe <State>

Switches the channel signal on or off.

Suffix:

<m> Selects the input channel (1, 2).

Parameters:

<State> ON | OFF

CHANnel<m>:COUPling <Coupling>

Selects the connection of the indicated channel signal.

Suffix:

<m> Selects the input channel (1, 2).

Parameters:

<Coupling> DCLimit | ACLimit | GND

DCLimit

DC coupling

ACLimit

AC coupling

GND

Ground

*RST: DCL

CHANnel<m>:SCALE <Scale>

Sets the vertical scale for the indicated channel.

Suffix:

<m> Selects the input channel (1, 2).

Parameters:

<Scale> Scale value, given in Volts per division.

Range: 1e-3 to 10

*RST: 5e-3

CHANnel<m>:RANGe <Range>

Sets the voltage range across the 8 vertical divisions of the diagram. Use the command alternatively instead of [CHANnel<m>:SCALE](#).

Suffix:

<m> Selects the input channel (1, 2).

Parameters:

<Range> Voltage range value
 Range: 8e-3 to 80
 *RST: 40e-3

CHANnel<m>:POSition <Position>

Sets the vertical position of the indicated channel and its horizontal axis in the window.

Suffix:

<m> Selects the input channel (1, 2).

Parameters:

<Position> Position value, given in divisions.
 Range: -4 to 4
 *RST: 0

CHANnel<m>:OFFSet <Offset>

The offset voltage is subtracted to correct an offset-affected signal.

Suffix:

<m> Selects the input channel (1, 2).

Parameters:

<Offset> Offset value in V
 Range: Values depend on vertical scale and probe attenuation.
 *RST: 0

CHANnel<m>:BANDwidth <BandwidthLimit>

Selects the bandwidth limit for the indicated channel.

Suffix:

<m> Selects the input channel (1, 2).

Parameters:

<BandwidthLimit> FULL | B20
FULL
 Use full bandwidth.
B20
 Bandwidth limit 20 MHz.
 *RST: FULL

CHANnel<m>:POLarity <Polarity>

Turns the inversion of the signal amplitude on or off. To invert means to reflect the voltage values of all signal components against the ground level. Inversion affects only the display of the signal but not the trigger.

Suffix:
<m> Selects the input channel (1, 2).

Parameters:
<Polarity> NORMal | INVerted
*RST: NORM

CHANnel<m>:OVERload <Overload>

Retrieves the overload status of the specified channel from the status bit. When the overload problem is solved, the command resets the status bit.

Suffix:
<m> Selects the input channel (1, 2).

Parameters:
<Overload> ON | OFF
Use OFF to reset the overload status bit.
*RST: OFF

Example:
CHANnel12:OVERload?
Queries the overload status of channel 2.
CHANnel12:OVERload OFF
Resets the overload status bit.

CHANnel<m>:SKEW <Skew>

Skew or deskew compensates delay differences between channels caused by the different length of cables, probes, and other sources. Correct deskew values are important for accurate triggering.

Suffix:
<m> Selects the input channel (1, 2).

Parameters:
<Skew> Deskew value in s.

CHANnel<m>:THReshold <Threshold>

Threshold value for digitization of analog signals. If the signal value is higher than the threshold, the signal state is high (1 or true for the boolean logic). Otherwise, the signal state is considered low (0 or false) if the signal value is below the threshold.

Suffix:
<m> Selects the input channel (1, 2).

Parameters:
<Threshold> Default values are:
TTL: 1.4 V
ECL: -1.3 V
CMOS: 2.5 V

*RST: 5.00E-01

CHANnel<m>:THReshold:FINDlevel

Sets the appropriate threshold level automatically.

Suffix:

<m> Selects the input channel (1, 2).

Usage:

Event

CHANnel<m>:THReshold:HYSTeresis <ThresholdHyst>

Defines the size of the hysteresis to avoid the change of signal states due to noise.

Suffix:

<m> Selects the input channel (1, 2).

Parameters:

<ThresholdHyst> SMAL | MEDium | LARGe

*RST: SMAL

CHANnel<m>:LABel <Label>

Set the label for the input channel.

Suffix:

<m> Selects the input channel (1, 2).

Parameters:

<Label> String value "xxxxxxx" with maximum 8 ASCII characters.

CHANnel<m>:LABel:STATe <State>

Switches the label of the channel on or off.

Suffix:

<m> Selects the input channel (1, 2).

Parameters:

<State> ON | OFF

*RST: OFF

14.3.5 Waveform Data

FORMat[:DATA].....	185
FORMat:BORDER.....	186
CHANnel<m>:DATA?.....	186
CHANnel<m>:DATA:HEADer?.....	186
CHANnel<m>:DATA:POINts.....	187
CHANnel<m>:DATA:XINCrement?.....	188

CHANnel<m>:DATA:XORigin?	188
CHANnel<m>:DATA:YINCrement?	188
CHANnel<m>:DATA:YORigin?	189
CHANnel<m>:DATA:YRESolution?	189
CHANnel<m>:DATA:ENVELOpe?	189
CHANnel<m>:DATA:ENVELOpe:HEADer?	189
CHANnel<m>:DATA:ENVELOpe:XINCrement?	190
CHANnel<m>:DATA:ENVELOpe:XORigin?	190
CHANnel<m>:DATA:ENVELOpe:YINCrement?	190
CHANnel<m>:DATA:ENVELOpe:YORigin?	191
CHANnel<m>:DATA:ENVELOpe:YRESolution?	191

FORMat[:DATA] <DataFormat>,<Accuracy>

Defines the format for data export with

- CHANnel<m>:DATA?
- CHANnel<m>:DATA:ENVELOpe?
- REFCurve<m>:DATA?
- CALCulate:QMATH:DATA?

Parameters:

<DataFormat> ASCII | REAL | UINTEger | CSV

ASCII

List of values, for example, 1.23,1.22,1.24,..

<Accuracy> is 0 which means that the instrument selects the number of digits to be returned. The query returns ASC,0.

REAL

Block data, 32 bit float values in 4 byte blocks.

<Accuracy> is always 32. The query returns REAL,32.

UINTEger

Unsigned integer format, binary values with length 8 or 16 bit (UINT,8 or UINT,16). The data range for UINT,8 is 0 to 255, the data range for UINT,16 is 0 to 65.535.

For data conversion, you need the results of following commands:

```
...:DATA:XORigin?; ...:DATA:XINCrement?; ...:DATA:
Yorigin?; ...:DATA:YINCrement?; ...:DATA:
YRESolution?..
```

CSV

Comma separated value list.

```
*RST:      ASC
```

<Accuracy> 0 | 8 | 16 | 32

Length of a data value in bit

```
*RST:      0
```

Example:

Set the ASCII data format:

```
FORM ASC
```

Example: Query the data format:
 FORM?
 -> ASC,0

FORMat:BORDER <ByteOrder>

Defines the byte order for binary data export if [FORMat \[:DATA\]](#) is set to REAL or UINT.

Parameters:

<ByteOrder> MSBFirst | LSBFirst

MSBFirst

Big endian, most significant byte first, for example:
 abcd,acbe,abcf, ...

LSBFirst

Little endian, least significant byte first, for example:
 dcba,ebca,fcba, ...

*RST: MSBF

CHANnel<m>:DATA?

Returns the data of the channel waveform points. The waveforms data can be used in MATLAB, for example.

For envelope waveforms, use the [CHANnel<m>:DATA:ENVELOpe?](#) command.

Suffix:

<m> Selects the input channel (1, 2).

Return values:

<Data> Comma-separated list of vertical values (voltages of recorded waveform samples).

Example:

```
CHAN1:DATA?
-0.125000,-0.123016,-0.123016,-0.123016,
-0.123016,-0.123016,...
```

Usage:

Query only

CHANnel<m>:DATA:HEADer?

Returns information on the channel waveform. For envelope waveforms, use the [CHANnel<m>:DATA:ENVELOpe:HEADer?](#) command.

Table 14-1: Header data

Position	Meaning	Example
1	XStart in s	-9.477E-008 = - 94,77 ns
2	XStop in s	9.477E-008 = 94,77 ns

Position	Meaning	Example
3	Record length of the waveform in samples	200000
4	Number of values per sample interval, usually 1.	1

Suffix:

<m> Selects the input channel (1, 2).

Return values:

<DataHeader> Comma-separated value list.

Example: `-9.477E-008,9.477E-008,200000,1`

Usage:

Query only

CHANnel<m>:DATA:POINTs <Points>

As a setting, the command selects a range of samples. As a query, it returns the number of samples for the selected range. To get correct results with settings MAX and DMAX, the acquisition must not run when the command is used. To acquire consistent and valid data, use the SINGLE command before. Do not cancel a running acquisition with STOP because the waveform data might be incomplete or incorrect.

Suffix:

<m> Selects the input channel (1, 2).a

Setting parameters:

<Points> DEFault | MAXimum | DMAXimum

Sets the range for the queries.

DEFault

Waveform samples displayed on the screen.

MAXimum

Range is the complete memory.

Note: Reading the complete memory is only possible in STOP mode, and if maximum sample rate is set ([ACQUIRE:WRATE](#) [ACQ:WRAT MSAM](#))

DMAXimum (Display Maximum)

Number of samples in the current waveform record.

Return values:

<Points>

Number of data points in the selected range (samples). The number of data points is depending on the timebase and channel settings.

Example: The instrument recorded 10000 samples. 6000 of these samples apply to the screen. To create the display points, every 6 points are combined to a MIN-MAX pair, and 1000 of these data pairs are displayed on the screen. For DEFault, 2000 is returned (1000 data pairs). DMAX returns 6000, and MAX 10000 (the complete memory).

Record mode „AUTOMATIC“ (ACQUIRE menu) in STOP mode

CHAN1:DATA:POIN MAX

CHAN1:DATA:POIN?

Response: 240000

Record mode „MAX.SA.RATE“ (ACQUIRE menu) in STOP mode

CHAN1:DATA:POIN MAX

CHAN1:DATA:POIN?

Response: 1048560

CHANnel<m>:DATA:XINCrement?

Returns the time difference between two adjacent samples of the indicated waveform. The command is relevant for data conversion, if binary data format is defined (FORM UINT,8|16|32).

Suffix:

<m> Selects the input channel (1, 2).

Return values:

<Xincrement> Time in s.

Usage: Query only

CHANnel<m>:DATA:XORigin?

Returns the time of the first sample of the indicated waveform. The command is relevant for data conversion, if binary data format is defined (FORM UINT,8|16|32).

Suffix:

<m> Selects the input channel (1, 2).

Return values:

<Xorigin> Time in s.

Usage: Query only

CHANnel<m>:DATA:YINCrement?

Returns the voltage value per bit of the indicated waveform. The command is relevant for data conversion, if binary data format is defined (FORM UINT,8|16|32).

Suffix:

<m> Selects the input channel (1, 2).

Return values:
 <Yincrement> Voltage in V.

Usage: Query only

CHANnel<m>:DATA:YORigin?

Returns the voltage value for binary value 0 of the indicated waveform. The command is relevant for data conversion, if binary data format is defined (FORM UINT,8|16|32).

Suffix:
 <m> Selects the input channel (1, 2).

Return values:
 <Yorigin> Voltage in V.

Usage: Query only

CHANnel<m>:DATA:YRESolution?

Return the vertical bit resolution of the indicated waveform. The command is relevant for data conversion, if binary data format is defined (FORM UINT,8|16|32).

Suffix:
 <m> Selects the input channel (1, 2).

Return values:
 <Yresolution> For default waveforms, the resolution is 8 bit.
 If high resolution, average or filter are set, the resolution is 16 bit.

Usage: Query only

CHANnel<m>:DATA:ENVELOpe?

Returns the data of the envelope. The envelope consists of two waveforms. The waveforms data can be used in MATLAB, for example.

Use this command only for envelope waveforms. For other channel waveforms use [CHANnel<m>:DATA?](#).

Suffix:
 <m> Selects the input channel (1, 2).

Return values:
 <Data> Comma-separated list of vertical values (voltages of envelope points). The list contains two values for each sample interval.

Usage: Query only

CHANnel<m>:DATA:ENVELOpe:HEADer?

Returns information on the envelope waveform.

Use this command only for envelope waveforms. For all other channel waveforms use `CHANnel<m>:DATA:HEADer?`.

Position	Meaning	Example
1	XStart in s	-9.477E-008 = -94,77 ns
2	XStop in s	9.477E-008 = 94,77 ns
3	Number of samples	1200
4	Number of values per sample interval. For envelope waveforms the value is 2.	2

Suffix:

<m> Selects the input channel (1, 2).

Return values:

<DataHeader> Comma-separated value list.

Example: -9.477E-008, 9.477E-008, 1200, 2

Usage:

Query only

CHANnel<m>:DATA:ENVELOpe:XINCrement?

Returns the time difference between two adjacent samples of the indicated waveform. The command is relevant for data conversion, if binary data format is defined (FORM UINT,8|16|32).

Suffix:

<m> Selects the input channel (1, 2).

Return values:

<Xincrement> Time in s.

Usage:

Query only

CHANnel<m>:DATA:ENVELOpe:XORigin?

Returns the time of the first sample of the indicated waveform. The command is relevant for data conversion, if binary data format is defined (FORM UINT,8|16|32).

Suffix:

<m> Selects the input channel (1, 2).

Return values:

<Xorigin> Time in s.

Usage:

Query only

CHANnel<m>:DATA:ENVELOpe:YINCrement?

Returns the voltage value per bit of the indicated waveform. The command is relevant for data conversion, if binary data format is defined (FORM UINT,8|16|32).

Suffix:	
<m>	Selects the input channel (1, 2).
Return values:	
<Yincrement>	Voltage in V.
Usage:	Query only

CHANnel<m>:DATA:ENVELOpe:YORigin?

Returns the voltage value for binary value 0 of the indicated waveform. The command is relevant for data conversion, if binary data format is defined (FORM UINT,8|16|32).

Suffix:	
<m>	Selects the input channel (1, 2).
Return values:	
<Yorigin>	Voltage in V.
Usage:	Query only

CHANnel<m>:DATA:ENVELOpe:YRESolution?

Return the vertical bit resolution of the indicated waveform. The command is relevant for data conversion, if binary data format is defined (FORM UINT,8|16|32).

Suffix:	
<m>	Selects the input channel (1, 2).
Return values:	
<Yresolution>	For default waveforms, the resolution is 8 bit. If high resolution, average or filter are set, the resolution is 16 bit.
Usage:	Query only

14.3.6 Waveform Data Export to File

EXPort:WAVEform:SOURce.....	191
EXPort:WAVEform:NAME.....	192
EXPort:WAVEform:SAVE.....	192

EXPort:WAVEform:SOURce <WaveformSource>

Defines the waveform to be exported.

Parameters:	
<WaveformSource>	CH1 CH2 D0...7 QMA RE1..4
	CH1 CH2 Analog channels CH1 CH2.
	D0...7 Pod, digital channels D0 to D7 are exported together

QMA

Quick Mathematics waveform

RE1..4

Reference waveforms RE1 | RE2 | RE3 | RE4.

EXPort:WAVeform:NAME <FileName>

Defines the path and file name for a waveform data file that will be saved with `EXPort:WAVeform:SAVE`. Depending on which USB port the flash drive is connected to, you either choose “/USB_FRONT” or “/USB_REAR” to specify the correct location. Additionally, the format type via FORM {ASC, REAL, UINT, CSV} and the number of points to export via `CHANnel<m>:DATA:POINts` should be defined.

Existing files will be overwritten.

Existing files will be overwritten. You can change the storage location, file name and/or file format manually in the menu. Remote control uses the recent settings.

Parameters:

<FileName> String parameter

Example:

```
FORM CSV
EXP:WAV:SOUR CH1
EXP:WAV:NAME "/USB_FRONT/CHANNEL1.CSV"
EXP:WAV:SAVE
```

The waveform data is saved to CHANNEL1.CSV.

EXPort:WAVeform:SAVE

Saves the waveform and starts the export to USB drive.

Usage: Event

14.3.7 Logic Channel

<code>LOGic<I>:POSition</code>	193
<code>LOGic<I>:SIZE</code>	193
<code>LOGic<I>:STATe</code>	193
<code>LOGic<I>:LABel</code>	193
<code>LOGic<I>:LABel:State</code>	193
<code>POD:THReshold</code>	194
<code>POD:THReshold:UDLevel<u></code>	194
<code>POD:State</code>	194
<code>POD:DATA?</code>	194
<code>POD:DATA:HEADer?</code>	195
<code>POD:DATA:POINts</code>	195
<code>POD:DATA:XINCrement?</code>	196
<code>POD:DATA:XORigin?</code>	196
<code>POD:DATA:YINCrement?</code>	196
<code>POD:DATA:YORigin?</code>	196

POD:DATA:YRESolution?.....	196
POD:CURRent:STATe:MINimum?.....	197
POD:CURRent:STATe:MAXimum?.....	197

LOGic<I>:POSition <Position>

Set the position of a logic channel.

Suffix:

<I> Selects the logic channel (0...7).

Parameters:

<Position> Position value in divisions.

LOGic<I>:SIZE <Size>

Set the size of the display of the logic channel.

Suffix:

<I> Selects the logic channel (0...7).

Parameters:

<Size> SMAL | MEDium | LARGe

*RST: SMAL

LOGic<I>:STATe <State>

Switches the channel signal on or off.

Suffix:

<I> Selects the logic channel (0...7).

Parameters:

<State> ON | OFF

LOGic<I>:LABel <Label>

Set the label for the logic channel.

Suffix:

<I> Selects the logic channel (0...7).

Parameters:

<Label> String value "xxxxxxx" with maximum 8 ASCII characters.

LOGic<I>:LABel:State <Label>

Switches the label of the logic channel on or off.

Suffix:

<I> Selects the logic channel (0...7).

Parameters:

<Label> ON | OFF

POD:THReshold <Threshold Mode>

Threshold Mode for Logic Pod. If the signal value is higher than the threshold, the signal state is high (1 or true for the boolean logic). Otherwise, the signal state is considered low (0 or false) if the signal value is below the threshold.

Parameters:

<Threshold Mode> TTL | ECL | CMOS | USER1 | USER2

TTL

TTL level, set to 1.4V

ECL

ECL level, set to -1.3V

CMOS

CMOS level, set to 2.5V

USER1

USER1 level, can be set with [POD:THReshold:UDLevel<u>](#).

USER2

USER1 level, can be set with [POD:THReshold:UDLevel<u>](#).

POD:THReshold:UDLevel<u> <Threshold Level>

Set the user-defined threshold for the pod.

Suffix:

<u> Select the user setting. (USER1, USER2)

Parameters:

<Threshold Level> Threshold level in V.
Range: -2 to 8 V

POD:State <State>

Switches the Pod on or off.

Parameters:

<State> ON | OFF
*RST: OFF

POD:DATA?

Returns the data of the specified digital channel. To set the export format, use [FORMat \[:DATA \]](#). To set the range of samples to be returned, use [POD:DATA:POINTs](#).

Return values:

<WaveformData> List of values according to the format settings.

Example: FORM ASC,0
 POD:DATA?
 1,1,1,1,1,1,0,0,0,0,0,0,...

Usage: Query only

POD:DATA:HEADer?

Returns information on the digital channel waveform.

Position	Meaning	Example
1	XStart in s	-9.477E-008 = - 94,77 ns
2	XStop in s	9.477E-008 = 94,77 ns
3	Record length of the waveform in samples	200000
4	Number of values per sample interval, usually 1.	1

Return values:

<Header> Comma-separated value list.

Example: -9.477E-008,9.477E-008,200000,1

Usage: Query only

POD:DATA:POINts <PointSelection>

As a setting, the command selects a range of samples that will be returned with [POD:DATA?](#). As a query, the command returns the number of returned samples for the selected range. If [ACQUIRE:WRATe](#) is set to MSAMples (maximum sample rate), the memory usually contains more data samples than the screen can display. In this case, you can decide which data will be saved: samples stored in the memory or only the displayed samples.

Parameters:

<PointSelection> DEFault | MAXimum | DMAXimum
 Sets the range for data queries.

DEFault

Waveform samples displayed on the screen.

MAXimum

Range is the complete memory

Note: Reading the complete memory is only possible in STOP mode, and if maximum sample rate is set ([ACQUIRE:WRATe ACQ:WRAT MSAM](#))

DMAXimum (Display Maximum)

Number of samples in the current waveform record.

*RST: DEFault

Return values:

<Points> Number of data points in the selected range.
 Default unit: Samples

See also: [CHANnel<m>:DATA:POINTs](#)

POD:DATA:XINCrement?

Returns the time difference between two adjacent samples of the indicated waveform. The command is relevant for data conversion, if binary data format is defined (FORM UINT,8|16|32).

Return values:

<Xincrement> Time in s.

Usage: Query only

POD:DATA:XORigin?

Returns the time of the first sample of the indicated waveform. The command is relevant for data conversion, if binary data format is defined (FORM UINT,8|16|32).

Return values:

<Xorigin> Time in s.

Usage: Query only

POD:DATA:YINCrement?

Returns the voltage value per bit of the indicated waveform. The command is relevant for data conversion, if binary data format is defined (FORM UINT,8|16|32).

Return values:

<Yincrement> Voltage in V.

Usage: Query only

POD:DATA:YORigin?

Returns the voltage value for binary value 0 of the indicated waveform. The command is relevant for data conversion, if binary data format is defined (FORM UINT,8|16|32).

Return values:

<Yorigin> Voltage in V.

Usage: Query only

POD:DATA:YRESolution?

Return the vertical bit resolution of the indicated waveform. The command is relevant for data conversion, if binary data format is defined (FORM UINT,8|16|32).

Return values:

<Yresolution> For default waveforms, the resolution is 8 bit.
If high resolution, average or filter are set, the resolution is 16 bit.

Usage: Query only

POD:CURRent:STATe:MINimum?**POD:CURRent:STATe:MAXimum?**

Both commands together return the current status of the digital channel regardless of the trigger settings and even without any acquisition.

POD:CURR:STAT:MIN returns	POD:CURR:STAT:MAX returns	Signal
0	0	Low
1	1	High
0	1	Toggle

Return values:

<CurrentState> Range: 0 | 1

Usage: Query only

14.3.8 Probes

PROBe<m>:SETup:TYPE?.....	197
PROBe<m>:SETup:ATTenuation:UNIT.....	198
PROBe<m>:SETup:ATTenuation:MANual.....	198
PROBe<m>:SETup:ATTenuation[:AUTO]?.....	198

PROBe<m>:SETup:TYPE?

Queries the type of the probe.

Suffix:

<m> Selects the input channel (1, 2).

Return values:

<Type> NONE | ACTive | PASSive

NONE

Not detected

ACTive

Active probe

PASSive

Passive probe

Usage: Query only

PROBe<m>:SETup:ATTenuation:UNIT <Unit>

Selects the unit that the probe can measure.

Suffix:

<m> Selects the input channel (1, 2).

Parameters:

<Unit> V | A

PROBe<m>:SETup:ATTenuation:MANual <ManualAttenuation>

Sets the attenuation or gain of the probe if the probe was not detected by the instrument.

Suffix:

<m> Selects the input channel (1, 2).

Parameters:

<ManualAttenuation> Range: 0.001 to 10000
*RST: 1

PROBe<m>:SETup:ATTenuation[:AUTO]?

Returns the attenuation of an automatically detected probe.

Suffix:

<m> Selects the input channel (1, 2).

Return values:

<ProbeAttenuation> Range: 0.001 to 1000

Usage:

Query only

14.4 Trigger

- [General A Trigger Settings](#).....198
- [Edge Trigger](#).....201
- [Width \(Pulse\) Trigger](#).....202
- [Video/TV Trigger](#).....204
- [Pattern \(Logic\) Trigger](#).....205

14.4.1 General A Trigger Settings

TRIGger:A:MODE	199
TRIGger:A:LEVel<n>[:VALue]	199
TRIGger:A:SOURce	199
TRIGger:A:TYPE	200
TRIGger:A:HOLDoff:MODE	200
TRIGger:A:HOLDoff:TIME	200

TRIGger:OUT:MODE.....	200
TRIGger:EXTErn:COUPling.....	201
TRIGger:OUT:POLarity.....	201
TRIGger:OUT:PLENght.....	201

TRIGger:A:MODE <TriggerMode>

Sets the trigger mode. The trigger mode determines the behaviour of the instrument if no trigger occurs.

Parameters:

<TriggerMode> AUTO | NORMal

AUTO

The instrument triggers repeatedly after a time interval if the trigger conditions are not fulfilled. If a real trigger occurs, it takes precedence.

NORMal

The instrument acquires a waveform only if a trigger occurs.

*RST: AUTO

TRIGger:A:LEVel<n>[:VALue] <Level>

Sets the trigger treshold voltage for edge and width trigger.

Suffix:

<n> Selects the trigger input. 1, 2 selects the corresponding channel, 5 selects the external trigger input.

Parameters:

<Level> Trigger level in V.

Range: Depends on vertical scale.

TRIGger:A:SOURce <Source>

Sets the trigger source.

Parameters:

<Source> CH1 | CH2 | D0...D7 | EXTErnalog | LINE | PATTErn | NONE

CH1 | CH2:

Analog channels

D0...D7:

Digital channels

EXTErnalog:

External TRIG IN connector on the front panel

LINE:

AC line for the edge trigger

PATTErn:

Pattern

NONE:

No trigger source selected

*RST: CH1

TRIGger:A:TYPE <Type>

Sets the trigger type.

Parameters:

<Type> EDGE | WIDTH | TV | LOGic | BUS

EDGE:

Edge trigger

WIDTH:

Pulse trigger

TV:

Video trigger

LOGic:

Logic trigger

BUS:

BUS trigger requires that at least one serial protocol option is installed.

*RST: EDGE

TRIGger:A:HOLDoff:MODE <HoldOffMode>

Enables or disables the holdoff time.

Parameters:

<HoldOffMode> TIME | OFF

*RST: Off

TRIGger:A:HOLDoff:TIME <HoldOffTime>

Defines the holdoff time. The next trigger occurs only after the holdoff time has passed.

Parameters:

<HoldOffTime> Range: 5.00000E-08 to 1.00000E+01

Default unit: s

TRIGger:OUT:MODE <OutputMode>

Sets the trigger output mode. Defines the trigger output mode whether and when a trigger out pulse is generated.

Parameters:

<OutputMode> OFF | TRIGger | MASK | GENerator

TRIGger:

Trigger event

MASK:
Mask violation

GENerator:
Generator signal

*RST: OFF

TRIGger:EXtern:COUPling <ExternCoupling>

Sets the coupling for the external trigger input. The command is relevant if [TRIGger:A:SOURce](#) is set to `EXternanalog`.

Parameters:
<ExternCoupling> AC | DC
*RST: AC

TRIGger:OUT:POLarity <Polarity>

Sets the polarity of the trigger out pulse.

Parameters:
<Polarity> POSitive | NEGative
*RST: POS

TRIGger:OUT:PLENght <PulseLength>

Sets the trigger output pulse length.

Parameters:
<PulseLength> *RST: 1E-6
Default unit: s

14.4.2 Edge Trigger

TRIGger:A:EDGE:SLOPe	201
TRIGger:A:EDGE:COUPling	202
TRIGger:A:EDGE:FILTer:LPASS	202
TRIGger:A:EDGE:FILTer:NREJect	202

TRIGger:A:EDGE:SLOPe <Slope>

Sets the slope for the edge trigger (A trigger).

Parameters:
<Slope> POSitive | NEGative | EITHER

POSitive
Rising edge, a positive voltage change

NEGative
Falling edge, a negative voltage change

EITHer

Rising as well as the falling edge

*RST: POSitive

TRIGger:A:EDGE:COUPling <Coupling>

Sets the coupling for the trigger source.

Parameters:

<Coupling> DC | AC | HF | ALEVel

DC

Direct Current coupling. The trigger signal remains unchanged.

AC

Alternating Current coupling. A 5 Hz high pass filter removes the DC offset voltage from the trigger signal.

HF

High frequency coupling. A 15 kHz high-pass filter removes lower frequencies from the trigger signal. Use this mode only with very high frequency signals.

ALEVel

Auto Level

*RST: DC

TRIGger:A:EDGE:FILTer:LPASs <State>

Turns an additional 5 kHz low-pass filter in the trigger path on or off. This filter removes higher frequencies and is available with AC and DC coupling.

Parameters:

<State> ON | OFF

*RST: OFF

TRIGger:A:EDGE:FILTer:NREJect <State>

Turns an additional 100 MHz low-pass filter in the trigger path on or off. This filter removes higher frequencies and is available with AC and DC coupling.

Parameters:

<State> ON | OFF

*RST: OFF

14.4.3 Width (Pulse) Trigger

TRIGger:A:WIDTh:POLarity.....	203
TRIGger:A:WIDTh:RANGe.....	203
TRIGger:A:WIDTh:WIDTh.....	203
TRIGger:A:WIDTh:DELTA.....	203

TRIGger:A:WIDTH:POLarity <Polarity>

Sets the polarity of the pulse trigger function.

Parameters:

<Polarity> POSitive | NEGative

POSitive

Positive going pulse, the width is defined from the rising to the falling slopes.

NEGative

Negative going pulse, the width is defined from the falling to the rising slopes.

*RST: POSitive

TRIGger:A:WIDTH:RANGe <RangeMode>

Defines how the measured pulse width is compared with the given limit(s) .

Parameters:

<RangeMode> WITHin | OUTSide | SHORter | LONGer

WITHin | OUTSide

Triggers on pulses inside or outside a range defined by *time ± delta*. The time is specified with [TRIGger:A:WIDTH:WIDTH](#), the range around is defined with [TRIGger:A:WIDTH:DELTA](#).

SHORter | LONGer

Triggers on pulses shorter or longer than a time set with [TRIGger:A:WIDTH:WIDTH](#).

*RST: LONGer

TRIGger:A:WIDTH:WIDTH <Time1>

For the ranges WITHin and OUTSide (defined using [TRIGger:A:WIDTH:RANGe](#)), the <Time1> defines the center of a range which is defined by the limits \pm <Delta> (set with [TRIGger:A:WIDTH:DELTA](#)).

For the ranges SHORter and LONGer, the width defines the maximum and minimum pulse width, respectively.

Parameters:

<Time1> Center value, maximum value or minimum value depending on the defined range type.

Range: 1.6E-08 to 3.435974E+01

TRIGger:A:WIDTH:DELTA <Delta>

Defines a range around the width value specified using [TRIGger:A:WIDTH:WIDTH](#).

Parameters:

<Delta>	±Δt ("Variation" softkey)
Range:	Depends on the defined pulse width (TRIG:A:WIDTH:WIDTH)
*RST:	3.2E-9

14.4.4 Video/TV Trigger

TRIGger:A:TV:STANdard.....	204
TRIGger:A:TV:POLarity.....	204
TRIGger:A:TV:FIELD.....	204
TRIGger:A:TV:LINE.....	205

TRIGger:A:TV:STANdard <Standard>

Selects the color television standard.

Parameters:

<Standard>	PAL NTSC SECam PALM I576 P720 P1080 I1080
*RST:	PAL

TRIGger:A:TV:POLarity <Polarity>

Sets the polarity of the sync pulses. The edges of the sync pulses are used for triggering.

Parameters:

<Polarity>	POSitive NEGative
POSitive	If the video modulation is positive, the sync pulses are negative.
NEGative	If the modulation is negative, sync pulses are positive.
*RST:	NEGative

TRIGger:A:TV:FIELD <Field>

Sets the trigger on the beginning of the video signal fields, or on the beginning of video signal lines.

Parameters:

<Field>	EVEN ODD ALL LINE ALINe
EVEN	Triggers only on even half frames.
ODD	Triggers only on odd half frames.
ALL	Triggers on all frames.

LINE

Triggers on the beginning of a specified line in any field.
The line number is set with `TRIGger:A:TV:LINE`

ALINE

Triggers on the beginning of all video signal lines.

*RST: ALL

TRIGger:A:TV:LINE <Line>

Sets an exact line number if `TRIGger:A:TV:FIELD` is set to LINE.

Parameters:

<Line>	Range:	1 to 525, 625, ..., 1080 depending on the TV standard
	*RST:	1

14.4.5 Pattern (Logic) Trigger

<code>TRIGger:A:PATtern:SOURce</code>	205
<code>TRIGger:A:PATtern:FUNCTion</code>	206
<code>TRIGger:A:PATtern:CONDition</code>	206
<code>TRIGger:A:PATtern:MODE</code>	206
<code>TRIGger:A:PATtern:WIDTh[:WIDTh]</code>	206
<code>TRIGger:A:PATtern:WIDTh:DELta</code>	207
<code>TRIGger:A:PATtern:WIDTh:RANGe</code>	207

TRIGger:A:PATtern:SOURce <SourceString>

Selects the state for each digital channel. The respective channel (CH1, CH2 or logic channels 0...7) has to be activated before state selecting.

Parameters:

<SourceString>	String containing 0, 1, or X for each channel.
1	High, the signal voltage is higher than the trigger level.
0	Low, the signal voltage is lower than the trigger level.
X	Don't care. The channel does not affect the trigger.

Example:

```
TRIG:A:PATT:SOUR „1X“
CH1 = High, CH2 = Don't care (POD deactivated)
TRIG:A:PATT:SOUR „00101X1X1X“
POD: 0 = High, 1 = Low, ... , 7 = Don't care (CH1 / CH2 deactivated)
```

TRIGger:A:PATtern:FUNcTion <Function>

Sets the logical combination of the trigger states of the channels.

Parameters:

<Function>	AND OR
	AND
	The required states of all channels must appear in the input signal at the same time.
	OR
	At least one of the channels must have the required state.
*RST:	AND

TRIGger:A:PATtern:CONDition <ConditionString>

Sets the trigger point depending on the result of the logical combination of the channel states.

Parameters:

<ConditionString>	„TRUE“ „FALSE“
*RST:	„TRUE“

TRIGger:A:PATtern:MODE <PatternMode>

Sets the duration function of the pattern trigger.

Parameters:

<PatternMode>	OFF TIMEout WIDTH
	OFF
	Pattern trigger without duration.
	TIMEout
	Defines how long at least the result of the state pattern condition must be true or false.
	WIDTH
	Width duration and comparison of the logical combined channels. The range is defined using TRIGger:A:PATtern:WIDTH:RANGe
*RST:	OFF

TRIGger:A:PATtern:WIDTH[:WIDTH] <PatternWidth>

For the ranges WITHin and OUTSide (defined using [TRIGger:A:PATtern:WIDTH:RANGe](#)), the <PatternWidth> defines the center of a range which is defined by the limits \pm <Delta> (set with [TRIGger:A:PATtern:WIDTH:DELTA](#)).

For the ranges SHORter and LONGer, the pattern width defines the maximum and minimum values, respectively.

Parameters:

<PatternWidth> Center value, maximum value or minimum value depending on the defined range type.

Range: 1.600E-08 to 3.435974E+01
 *RST: 3.9999999E-04
 Default unit: s

TRIGger:A:PATtern:WIDTh:DELTA <PatternDelta>

Defines a range around the pattern width value specified using [TRIGger:A:PATtern:WIDTh\[:WIDTh\]](#).

Parameters:

<PatternDelta> $\pm\Delta t$ ("Variation")

Range: 8.00E-09 to maximum value, which depends on the defined pulse width
 *RST: 1.5000000E-04

TRIGger:A:PATtern:WIDTh:RANGe <PatternRange>

Defines a range around the width value specified using [TRIGger:A:PATtern:WIDTh\[:WIDTh\]](#).

Parameters:

<PatternRange> WITHin | OUTSide | SHORter | LONGer

WITHin | OUTSide
 Triggers on pulses inside or outside a range defined by time \pm delta. The time is specified with [TRIGger:A:PATtern:WIDTh\[:WIDTh\]](#), the range around is defined with [TRIGger:A:PATtern:WIDTh:DELTA](#)

SHORter | LONGer
 Triggers on pulses shorter or longer than a time set with [TRIGger:A:PATtern:WIDTh\[:WIDTh\]](#)

*RST: LONGer

14.5 Display

- [Basic Display Settings](#).....207
- [Zoom](#).....213
- [Markers \(Timestamps\)](#).....214

14.5.1 Basic Display Settings

This chapter describes commands that configure the screen display.

14.5.1.1 General Display Settings

DISPlay:MODE.....	208
DISPlay:PALETTE.....	208
DISPlay:VSCreen:ENABle.....	209
DISPlay:VSCreen:POSition.....	209
DISPlay:DIALog:CLOSe.....	209
DISPlay:DIALog:MESSAge.....	209
DISPlay:DIALog:TRANSpArency.....	209
DISPlay:LANGUage.....	209
DISPlay:LANGUage:REMOve.....	210
DISPlay:LANGUage:ADD.....	210
DISPlay:LANGUage:CATalog?.....	210

DISPlay:MODE <Mode>

Sets the diagram mode.

Parameters:

<Mode>	YT XY
	YT
	Default time diagram with a time axis in x-direction and the signal amplitudes displayed in y-direction.
	XY
	XY-diagram, combines the voltage levels of two waveforms in one diagram.
	*RST: YT

DISPlay:PALETTE <Palette>

Sets the color and brightness of the displayed waveform samples depending on their cumulative occurrence.

Parameters:

<Palette>	NORMal INVerse FColor IFColor
	NORMal
	Values that occur frequently are brighter than rare values.
	INVerse
	Rare values are brighter than frequent values, inverse to the NORMal brightness.
	FColor
	Rare values are displayed in blue, while more frequent values are red and very frequent values are displayed in yellow or white, with various colors inbetween.
	IFColor
	Inverses the FColor setting: rare values are yellow or white while frequent values are blue.
	*RST: NORMal

DISPlay:VSCreen:ENABle <Enable>

Switches the virtual screen on or off.

Parameters:

<Enable> ON | OFF
 *RST: OFF

DISPlay:VSCreen:POSition <Position>

Set the position of the virtual screen window.

Parameters:

<Position> Range: 2 to -10
 *RST: 0

DISPlay:DIALog:CLOSE

Closes and opens dialog box.

Usage: Event

DISPlay:DIALog:MESSage <MessageText>

Sends a message text to the instrument and displays it in a message box.

To close the message box, use [DISPlay:DIALog:CLOSE](#).

Setting parameters:

<MessageText> String that contains the message.

Example: DISP:DIAL:MESS 'My message'
 DISP:DIAL:CLOS

Usage: Setting only

DISPlay:DIALog:TRANsparency <Transparency>

Sets the transparency of result boxes that overlay the waveforms, for example, boxes with statistical results or digital voltmeter results.

Parameters:

<Transparency> Range: 0 to 100
 Default unit: %

DISPlay:LANGuage <Language>

Sets the menu language. The *RST command does not reset the language setting.

Parameters:

<Language> ENGLISH | GERMAN | FRENCH | SPANISH | RUSSIAN |
 SCHINESE | TCHINESE | JAPANESE | KOREAN
 Supported languages are listed in the "Specifications" data
 sheet.

DISPlay:LANGUage:REMOve <Language>

Removes an installed menu language file from internal memory.

Setting parameters:

<Language> ENGLISH | GERMAN | FRENCH | SPANISH | RUSSIAN |
 SCHINESE | TCHINESE | JAPANESE | KOREAN

Example: DISP:LANG:REM GERM

Usage: Setting only

DISPlay:LANGUage:ADD <Language>,<SourcePath>

Adds a saved menu language file from USB stick to internal memory.

Setting parameters:

<Language> ENGLISH | GERMAN | FRENCH | SPANISH | RUSSIAN |
 SCHINESE | TCHINESE | JAPANESE | KOREAN

<SourcePath> String parameter containing source path and language file.

Example: DISP:LANG:ADD GERM, "/USB_FRONT/RTC_LN00.HLU"

Usage: Setting only

DISPlay:LANGUage:CATalog?

Returns all installed menu language files.

Return values:

<Catalog> ENGLISH | GERMAN | FRENCH | SPANISH | RUSSIAN |
 SCHINESE | TCHINESE | JAPANESE | KOREAN

Usage: Query only

14.5.1.2 XY-Setup

DISPlay:XY:XSource..... 210
 DISPlay:XY:Y1Source.....211

DISPlay:XY:XSource <Source>

Defines the source to be displayed in x direction in an XY-diagram, replacing the usual
 time base.

Parameters:

<Source> CH1 | CH2
 *RST: CH1

DISPlay:XY:Y1Source <Source>

Defines the (first) source to be displayed in y direction in an XY-diagram.

Parameters:

<Source> CH1 | CH2
 *RST: CH2

14.5.1.3 Intensities

DISPlay:INTensity:WAVEform.....	211
DISPlay:INTensity:BACKlight.....	211
DISPlay:INTensity:GRID.....	211
DISPlay:PERsistence:STATe.....	212
DISPlay:PERsistence:TIME.....	212
DISPlay:PERsistence:INFinite.....	212
DISPlay:PERsistence:TIME:AUTO.....	212
DISPlay:PERsistence:CLEar.....	212

DISPlay:INTensity:WAVEform <Intensity>

Defines the strength of the waveform line in the diagram. *RST does not change the intensity.

Parameters:

<Intensity> Value in percent
 Range: 0 to 100

DISPlay:INTensity:BACKlight <Intensity>

Defines the intensity of the background lighting of the display. *RST does not change the intensity.

Parameters:

<Intensity> Value in percent
 Range: 10 to 100

DISPlay:INTensity:GRID <Intensity>

Defines the intensity of the grid on the screen. *RST does not change the intensity.

Parameters:

<Intensity> Value in percent
 Range: 0 to 100

DISPlay:PERStence:StAte <State>

Defines whether the waveform persists on the screen or whether the screen is refreshed continuously.

Parameters:

<State> ON | OFF

ON

The waveform persists for the time defined using [DISPlay:PERStence:TIME](#).

OFF

The waveform does not persist on the screen. Only the currently measured values are displayed at any time.

*RST: OFF

DISPlay:PERStence:TIME <Time>

Persistence time if persistence is active (see [DISPlay:PERStence:StAte](#)).

Each new data point in the diagram area remains on the screen for the duration defined here. To set infinite persistence, use [DISPlay:PERStence:INFinite](#).

Parameters:

<Time> Range: 50E-3 to infinite

*RST: 50E-3

Default unit: s

DISPlay:PERStence:INFinite <InfPersistence>

Sets the persistence time to infinite if [DISPlay:PERStence:StAte](#) is ON. Each new data point remains on the screen infinitely until this setting is changed or the persistence is cleared.

Parameters:

<InfPersistence> ON | OFF

*RST: OFF

DISPlay:PERStence:TIME:AUTO <Auto>

The optimal persistence time is determined automatically by the instrument.

Parameters:

<Auto> ON | OFF

*RST: OFF

DISPlay:PERStence:CLEar

Removes the displayed persistent waveform from the screen.

Usage: Event

14.5.1.4 Waveform and Grid Settings

DISPlay:STYLe.....	213
DISPlay:GRID:STYLe.....	213

DISPlay:STYLe <Style>

Defines how the waveform data is displayed

Parameters:

<Style> VECTors | DOTs

VECTors

Individual data points are connected by a line.

DOTs

Only the data points are displayed.

*RST: VECT

DISPlay:GRID:STYL e <Style>

Defines how the grid is displayed.

Parameters:

<Style> LINes | RETicle | NONE

LINes

Displays the grid as horizontal and vertical lines.

RETicle

Displays crosshairs instead of a grid.

NONE

No grid is displayed.

*RST: LIN

14.5.2 Zoom

| | |
|-----------------------------|-----|
| TIMebase:ZOOM:STATe..... | 213 |
| TIMebase:ZOOM:SCALe..... | 214 |
| TIMebase:ZOOM:TIME..... | 214 |
| TIMebase:ZOOM:POSition..... | 214 |

TIMebase:ZOOM:STATe <ZoomState>

Switches the zoom window on or off.

Parameters:

<ZoomState> ON | OFF

*RST: OFF

TIMEbase:ZOOM:SCALE <ZoomScale>

Defines the time base in the zoom diagram in seconds per division.

Parameters:

<ZoomScale> Scaling of the zoom time base in s/div depending on time base and channel settings.

TIMEbase:ZOOM:TIME <Time>

Defines the offset of the trigger point to the reference point of the zoom diagram.

Parameters:

<Time> *RST: 0
 Default unit: s

TIMEbase:ZOOM:POSITION <Position>

Defines the position of the zoom reference point (the reference point of the zoom window) in relation to the reference point of original time base.

Parameters:

<Position> Value in %
 Range: 0 to 100, depending on the zoom time base
 *RST: 50

14.5.3 Markers (Timestamps)

| | |
|---------------------------------------|-----|
| TSTamp:SET | 214 |
| TSTamp:NEXT | 214 |
| TSTamp:PREVIOUS | 215 |
| TSTamp:CLEAR | 215 |
| TSTamp:ACLEAR | 215 |

TSTamp:SET

Sets a new marker (timestamp) at the reference point of the display, unless an existing marker is already set there. The reference point is set with [TIMEbase:REFERENCE](#).

Usage: Event

TSTamp:NEXT

Usage: Event

Moves the next marker (timestamp, to the right) to the reference point of the display or zoom area.

TSTamp:PREVIOUS

Moves the previous marker (timestamp, to the left) to the reference point of the display or zoom area.

Usage: Event

TSTamp:CLEar

Deletes the marker (timestamp) at the reference point. The reference point is set with [TIMebase:REFeRence](#).

Usage: Event

TSTamp:ACLEar

Deletes all markers (timestamps).

Usage: Event

14.6 Measurements

This chapter describes functions that configure or perform cursor and automatic measurements.

- [Cursor](#)..... 215
- [Quick View](#)..... 222
- [Automatic Measurements](#)..... 223

14.6.1 Cursor

In all CURSOR commands, the numeric suffix <m> is irrelevant. You can omit it.

| | |
|--|-----|
| CURSOR<m>:AOFF | 216 |
| CURSOR<m>:STATE | 216 |
| CURSOR<m>:FUNCTION | 216 |
| CURSOR<m>:SOURCE | 217 |
| CURSOR<m>:SWAVE | 218 |
| CURSOR<m>:SSCREEN | 218 |
| CURSOR<m>:SNPEAK | 218 |
| CURSOR<m>:SPPeak | 218 |
| CURSOR<m>:TRACKing[:STATE] | 218 |
| CURSOR<m>:X1Position | 218 |
| CURSOR<m>:X2Position | 219 |
| CURSOR<m>:X3Position | 219 |
| CURSOR<m>:Y1Position | 219 |
| CURSOR<m>:Y2Position | 219 |
| CURSOR<m>:Y3Position | 219 |

| | |
|---------------------------------------|-----|
| CURSor<m>:TRACking:SCALe[:STATe]..... | 219 |
| CURSor<m>:YCOupling..... | 220 |
| CURSor<m>:XCOupling..... | 220 |
| CURSor<m>:RESult?..... | 220 |
| CURSor<m>:XDELta:INVerse?..... | 220 |
| CURSor<m>:XDELta[:VALue]?..... | 220 |
| CURSor<m>:YDELta:SLOPe?..... | 220 |
| CURSor<m>:YDELta[:VALue]?..... | 221 |
| CURSor<m>:XRATio:UNIT..... | 221 |
| CURSor<m>:XRATio[:VALue]?..... | 221 |
| CURSor<m>:YRATio:UNIT..... | 222 |
| CURSor<m>:YRATio[:VALue]?..... | 222 |

CURSor<m>:AOFF

Switches the cursor off.

Suffix:

<m> 1
The numeric suffix is irrelevant.

Usage: Event

CURSor<m>:STATE <State>

Activates or deactivates the cursor measurement.

Suffix:

<m> 1
The numeric suffix is irrelevant.

Parameters:

<State> ON | OFF
*RST: OFF

CURSor<m>:FUNCTioN <Type>

Defines the cursor measurement type.

Parameters:

<Type> HOrizontal | VERTical | PAIRed | HRATio | VRATio | PPCount |
NPCount | RECount | FECount | MEAN | RMS | RTIME | FTIME |
PEAK | UPEakvalue | LPEakvalue
*RST: PAIR

| | |
|------------|---|
| HORizontal | Sets two horizontal cursor lines and measures the voltages at the two cursor positions and the delta of the two values. |
| VERTical | Sets two vertical cursor lines and measures the time from the trigger point to each cursor, the time between the two cursors and the frequency calculated from that time. |
| PAIRed | V-Marker |

| | |
|--|---|
| HRATio | Ratio of the x-values (e.g. a duty cycle) between the first and second cursors and the first and third cursors. |
| VRATio | Ratio of the y-values (e.g. overshooting) between the first and second cursors and the first and third cursors. |
| PPCount
NPCount
RECount
FECount | Count positive pulses
Count negative pulses
Count rising edges
Count falling edges

Sets two vertical and one horizontal cursor line. The time base is defined by the vertical cursors, the horizontal cursor defines the threshold value. |
| MEAN
RMS | Mean value
Root mean square

Values are measured between two vertical cursor lines. |
| RTIME
FTIME | Rise time, t_r
Fall time, t_f

The reference level for rise and fall time measurement is set with <code>REFLevel<m>:RELative:MODE</code> |
| PEAK
UPEakvalue
LPEakvalue | V_{pp} , absolute difference between the two peak values
V_{p+} , upper peak value
V_{p-} , lower peak value

Values are measured between two vertical cursor lines. |

CURSor<m>:SOURce <Source>

Defines the cursor measurement source as one of the active signal, reference or math channel.

Parameters:

<Source> NONE | CH1 | CH2 | QMA | RE1...RE4 | XY
CH1 | CH2
Active signal channels CH1 to CH2.
QMA
Active quick math channel.
RE1...RE4
Active reference channels RE1 to RE4.
XY
Active XY-waveform.
*RST: CH1

CURSor<m>:SWAVE

Autoset for cursor lines, sets the cursor lines to typical points of the waveform depending on the selected measurement type. For example, for voltage measurement, the cursor lines are set to the upper and lower peaks of the waveform. For time measurement, the cursor lines are set to the edges of two consecutive positive or two consecutive negative pulses.

Usage: Event

CURSor<m>:SSCReen

Resets the cursors to their initial positions. This is helpful if the cursors have disappeared from the display or need to be moved for a larger distance.

Usage: Event

CURSor<m>:SNPeak

For FFT analysis only: sets the selected cursor to the next (right) level peak.

Usage: Event

CURSor<m>:SPPeak

For FFT analysis only: sets the selected cursor to the previous (left) level peak.

Usage: Event

CURSor<m>:TRACking[:STATe] <State>

If set to ON, the V-Marker cursor measurement is enabled.

Suffix:

<m> 1
The numeric suffix is irrelevant.

Parameters:

<State> ON | OFF
*RST: OFF

CURSor<m>:X1Position <Xposition1>

Specifies the position of the first cursor on the time axis.

Parameters:

<Xposition1> Default unit: s

CURSor<m>:X2Position <Xposition2>

Specifies the position of the second cursor on the time axis.

Parameters:

<Xposition2> Default unit: s

CURSor<m>:X3Position <Xposition3>

Specifies the position of the third cursor on the time axis for the Ratio X measurement.

Parameters:

<Position> Default unit: s

CURSor<m>:Y1Position <Yposition1>

Specifies the position of the first horizontal cursor on the y-axis.

Parameters:

<Yposition1> Default unit: V

CURSor<m>:Y2Position <Yposition2>

Specifies the position of the second horizontal cursor on the y-axis.

Parameters:

<Yposition2> *RST: V

CURSor<m>:Y3Position <Yposition3>

Specifies the position of the third horizontal cursor on the y-axis for Ratio Y measurements.

Parameters:

<Position> Default unit: V

CURSor<m>:TRACking:SCALe[:STATe] <State>

Enables the adjustment of cursor lines if the vertical or horizontal scales are changed.

Parameters:

<State> ON | OFF

ON

Cursor lines keep their relative position to the waveform.

OFF

Cursor lines remain on their position on the display if the scaling is changed.

*RST: OFF

CURSor<m>:YCOupling <Coupling>

CURSor<m>:XCOupling <Coupling>

If enabled, the cursors of a set are coupled so that the distance between the two remains the same if one cursor is moved.

Suffix:

<m> 1
The numeric suffix is irrelevant.

Parameters:

<Coupling> ON | OFF
*RST: OFF

CURSor<m>:RESult?

Returns the cursor positions.

Return values:

<Value> Comma-separated list

Usage: Query only

CURSor<m>:XDELta:INVerse?

Returns the inverse time difference between the two cursors ($1/\Delta t$).

Suffix:

<m> 1
The numeric suffix is irrelevant.

Return values:

<DeltaInverse> Default unit: 1/s

Usage: Query only

CURSor<m>:XDELta[:VALue]?

Returns the time difference between the two cursors (Δt).

Return values:

<Delta> Default unit: s

Usage: Query only

CURSor<m>:YDELta:SLOPe?

Returns the inverse value of the voltage difference - the reciprocal of the vertical distance of two horizontal cursor lines: $1/\Delta V$.

Suffix:

<m> 1
The numeric suffix is irrelevant.

Return values:
 <DelyYslope> Inverse value

Usage: Query only

CURSor<m>:YDELta[:VALue]?

Queries the delta of the values in y-direction at the two cursors.

Suffix:
 <m> 1
 The numeric suffix is irrelevant.

Return values:
 <DeltaY> Delta value in V

Usage: Query only

CURSor<m>:XRATio:UNIT <Unit>

Sets the unit for X Ratio measurements with [CURSor<m>:XRATio\[:VALue\]?](#).

Parameters:
 <Unit> RATio | PCT | GRD | PI

RATio
 floating value

PCT
 percent

GRD
 degree

PI
 radian

*RST: RAT

CURSor<m>:XRATio[:VALue]?

Returns the ratio of the x-values (e.g. a duty cycle) between the first and second cursors and the first and third cursors: $(x_2-x_1)/(x_3-x_1)$.

Set the unit of the result with [CURSor<m>:XRATio:UNIT](#).

Return values:
 <Ratio> Numeric value corresponding to the specified unit.

Usage: Query only

CURSor<m>:YRATio:UNIT <Unit>

Sets the unit for Y Ratio measurements with `CURSor<m>:YRATio[:VALue]?`.

Parameters:

| | |
|--------|----------------|
| <Unit> | RATio PCT |
| | RATio |
| | floating value |
| | PCT |
| | percent |
| *RST: | RAT |

CURSor<m>:YRATio[:VALue]?

Provides three cursors and measures the ratio of the y-values (e.g. overshooting) between the first and second cursors and the first and third cursors: $(y_2 - y_1) / (y_3 - y_1)$.

Set the unit of the result with `CURSor<m>:YRATio:UNIT`.

Return values:

<Ratio> Numeric value corresponding to the specified unit.

Usage: Query only

14.6.2 Quick View

| | |
|--|-----|
| <code>MEASurement<m>:AOFF</code> | 222 |
| <code>MEASurement<m>:AON</code> | 222 |
| <code>MEASurement<m>:AREsult?</code> | 222 |

MEASurement<m>:AOFF

Stops the quick measurement.

Suffix:

<m> 1 (the suffix is irrelevant)

Usage: Event

MEASurement<m>:AON

Starts the quick measurement.

Suffix:

<m> 1 (the suffix is irrelevant)

Usage: Event

MEASurement<m>:AREsult?

Returns the results of the quick measurement.

| | |
|-----------------------|--|
| Suffix: | |
| <m> | 1 (the suffix is irrelevant) |
| Return values: | |
| <QuickMeasData> | List of values |
| | Quick measurement results are listed in the following order:
PEAK, UPE, LPE, CYCR, CYCM, PER, FREQ, RTIM , FTIM |
| Usage: | Query only |

14.6.3 Automatic Measurements

| | |
|---------------------------------|-----|
| MEASurement<m>[:ENABLE]..... | 223 |
| MEASurement<m>:SOURce..... | 223 |
| MEASurement<m>:CATegory?..... | 224 |
| MEASurement<m>:MAIN..... | 224 |
| MEASurement<m>:RESult?..... | 226 |
| MEASurement<m>:DELay:SLOPe..... | 227 |
| REFLevel<m>:RELative:MODE..... | 227 |

MEASurement<m>[:ENABLE] <State>

Activates or deactivates the selected measurement (1-6). Only the results of active measurements are displayed in the result table.

| | |
|----------------|----------------------------------|
| Suffix: | |
| <m> | 1..6
Selects the measurement. |

| | |
|--------------------|-----------------------|
| Parameters: | |
| <State> | ON OFF
*RST: OFF |

MEASurement<m>:SOURce <SignalSource>[,<ReferenceSource>]

Selects one of the active signal, reference or math channels as the source(s) of the selected measurement. Available sources depend on the selected measurement type.

| | |
|----------------|--|
| Suffix: | |
| <m> | 1..6
Selects the measurement place. |

| | |
|--------------------|--|
| Parameters: | |
| <SignalSource> | NONE CH1...CH2 QMA RE1...RE4 POD D0..7 TRIGger
EXTern
*RST: CH1 |
| <ReferenceSource> | NONE CH1...CH2 QMA RE1...RE4 POD D0..7 TRIGger
EXTern
CH1 CH2
Active signal channels 1 to 2. |

QMA

Active quick math channel QMA.

RE1...RE4

Active reference channels RE1 to RE4.

POD

Active logic POD.

D0...D7

Active digital channels D0 to D7.

TRIGger

TRIG is returned, if the measurement type is a trigger measurement source (TFRequency, TPERiode).

EXTErn

Active external signal.

MEASurement<m>:CATegory?

Returns the measurement category.

Suffix:

<m> 1..6
Selects the measurement.

Return values:

<Category> AMPTime | SPECTrum
AMPTime
Yt-measurements
SPECTrum
Spectrum measurements
*RST: AMPT

Usage: Query only

MEASurement<m>:MAIN <MeasType>

Defines the measurement type to be performed on the selected source. To query the results, use [MEASurement<m>:RESult?](#).

Suffix:

<m> 1..6
Selects the measurement.

Parameters:

<MeasType> FREquency | PERiod | PEAK | UPEakvalue | LPEakvalue |
PPCount | NPCount | RECount | FECount | HIGH | LOW |
AMPLitude | CREST | MEAN | RMS | RTIME | FTIME | PDCYcle |
NDCYcle | PPWidth | NPWidth | CYCMean | CYCRms |
STDDev | TFRequency | TPERiode | DELay | PHASe | BWIDth |
POVershoot | NOVershoot

FREQuency

Frequency of the signal. The result is based on the length of the leftmost signal period within the displayed section of the waveform of the selected channel.

PERiod

Length of the left-most signal period within the displayed section of the waveform of the selected channel.

PEAK

Peak-to-peak value within the displayed section of the waveform of the selected channel.

UPEakvalue

Maximum value within the displayed section of the waveform of the selected channel.

LPEakvalue

Minimum value within the displayed section of the waveform of the selected channel.

PPCount

Counts positive pulses.

NPCount

Counts negative pulses.

RECount

Counts the number of rising edges.

FECount

Counts the number of falling edges.

HIGH

Mean value of the high level of a square wave.

LOW

Mean value of the low level of a square wave.

AMPLitude

Amplitude of a square wave.

CRESt

The crest factor (peak-to-average ratio) is calculated from the maximum value divided by the RMS value of the waveform (Crest).

MEAN

Mean value of the complete displayed waveform of the selected channel.

RMS

RMS (Root Mean Square) value of the voltage of the complete displayed waveform of the selected channel.

RTIME | FTIME

Rise or falling time of the left-most rising edge within the displayed section of the waveform of the selected channel. The reference level for this measurement is set with `REFLevel<m>:RELative:MODE`.

PDCycle | NDCycle

Measure the positive or negative duty cycle.

PPWidth | NPWidth

Measure the width of positive or negative pulses.

CYCMean

Mean value of the left-most signal period of the waveform of the selected channel.

CYCRms

RMS (Root Mean Square) value of the voltage of the left-most signal period of the waveform of the selected channel.

STDDev

Measures the standard deviation of the waveform.

CYCStddev

Measures the standard deviation of one cycle, usually of the first, left-most signal period.

TFRequency | TPERiode

Measure the frequency of the trigger signal and the length of the its periods (hardware counter).

DELay

Time difference between two edges of the same or different waveforms. The waveforms are selected with `MEASurement<m>:SOURce`, and the edges with `MEASurement<m>:DELay:SLOPe`.

PHASe

Phase difference between two waveforms (time difference/ period * 360).

BWIDth

Duration of one burst, measured from the first edge to the last.

POVershoot | NOVershoot

Positive and negative overshoot of a square wave.

*RST: NONE (measurement is off)

The waveforms are selected with `MEASurement<m>:SOURce`

MEASurement<m>:RESult? [<MeasType>]

Returns the result of the specified measurement type.

Suffix:

<m>

1..6

Selects the measurement place.

Query parameters:

<MeasType> FREQuency | PERiod | PEAK | UPEakvalue | LPEakvalue |
 PPCount | NPCount | RECount | FECount | HIGH | LOW |
 AMPLitude | CRES t | MEAN | RMS | RTIME | FTIME | PDCYcle |
 NDCYcle | PPWidth | NPWidth | CYCMean | CYCRms |
 STDDev | TFRequency | TPERiode | DELay | PHASe | BWIDth |
 POVershoot | NOVershoot
 Specifies the measurement type. See [MEASurement<m>:MAIN](#).

Return values:

<Value> Measurement result

Usage: Query only

MEASurement<m>:DELay:SLOPe <SignalSlope>,<ReferenceSlope>

Sets the edges to be used for delay measurement. The associated waveforms are defined with [MEASurement<m>:SOURce](#)

Parameters:

<SignalSlope> POSitive | NEGative
 Slope of source 1 (first waveform)
 *RST: POS

<ReferenceSlope> POSitive | NEGative
 Slope of source 2 (second waveform)
 *RST: POS

REFLevel<m>:RELative:MODE <RelativeMode>

Sets the lower and upper reference levels for rise and fall time measurements (cursor and automatic measurements), defined as percentages of the high signal level.

Suffix:

<m> 1..5
 Measurement to which the reference level belongs.
 Suffix 1...4 assign the measurement places 1 to 4 (auto mea-
 sure).
 Suffix 5 assigns the cursor measurement.

Parameters:

<RelativeMode> TEN | TWENTy
TEN
 10/90%
TWENTy
 20/80%
 *RST: TEN

Example:

```
REFL2:REL:MODE TWENTy
MEAS2:MAIN RTIM
```

Sets the reference level for measurement place 2 and measures the rise time between these levels:

Lower reference level = 20% of high signal level

Upper reference level = 80% of high signal level

14.7 Quickmath and Reference Waveforms

- [Quickmath](#)..... 228
- [Reference Waveforms](#)..... 231

14.7.1 Quickmath

This chapter describes commands that configure or perform basic math functions using Quickmath.

| | |
|---|-----|
| CALCulate:QMATH:STATe | 228 |
| CALCulate:QMATH:SOURce | 228 |
| CALCulate:QMATH:OPERation | 229 |
| CALCulate:QMATH:SCALe | 229 |
| CALCulate:QMATH:POSition | 229 |
| CALCulate:QMATH:DATA? | 229 |
| CALCulate:QMATH:DATA:HEADer? | 229 |
| CALCulate:QMATH:DATA:XINCrement? | 230 |
| CALCulate:QMATH:DATA:XORigin? | 230 |
| CALCulate:QMATH:DATA:YINCrement? | 230 |
| CALCulate:QMATH:DATA:YORigin? | 230 |
| CALCulate:QMATH:DATA:YRESolution? | 231 |

CALCulate:QMATH:STATe <State>

Defines whether the Quickmath waveform is active or not. Only if a channel is active it is visible on the screen and can be selected as a source for analysis and display functions. Quickmath is only available in YT and Zoom mode.

Parameters:

<State> ON | OFF
 *RST: OFF

CALCulate:QMATH:SOURce <Source>

Defines the source of the Quickmath waveform.

Parameters:

<Source> CH1 | CH2
 *RST: 1

CALCulate:QMATH:OPERation <Operation>

Defines the operation of the Quickmath waveform.

Parameters:

<Operation> ADD | SUB | MUL | DIV
*RST: ADD

Example:

```
CALC:QMAT:OPER ADD
CALC:QMAT:OPER SUB
CALC:QMAT:OPER MUL
CALC:QMAT:OPER DIV
```

CALCulate:QMATH:SCALE <Scale>

Sets the vertical scale for the Quickmath waveform.

Parameters:

<Scale> Scale value, given in Volts per division.
Range: -1.0E-24 to 5.0E+25
*RST: 1

CALCulate:QMATH:POSITION <Position>

Sets the vertical position of the Quickmath waveform in the window.

Parameters:

<Position> Position value, given in divisions.
*RST: 0

CALCulate:QMATH:DATA?

Returns the data of the quick math waveform. The waveform data can be used in MATLAB, for example. To set the export format, use [FORMat \[:DATA\]](#)

Return values:

<Data> List of values according to the format settings.

Usage: Query only

CALCulate:QMATH:DATA:HEADER?

Returns information on the quick math waveform.

Table 14-2: Header data

| Position | Meaning | Example |
|----------|-------------|--------------------------|
| 1 | XStart in s | -9.477E-008 = - 94,77 ns |
| 2 | XStop in s | 9.477E-008 = 94,77 ns |

| Position | Meaning | Example |
|----------|--|---------|
| 3 | Record length of the waveform in Samples | 200000 |
| 4 | Number of values per sample interval, usually 1. | 1 |

Return values:

<DataHeader> Comma-separated value list.

Example: -9.477E-008,9.477E-008,200000,1

Usage: Query only

CALCulate:QMATH:DATA:XINCrement?

Returns the time difference between two adjacent samples of the indicated waveform. The command is relevant for data conversion, if binary data format is defined (FORM UINT,8|16|32).

Return values:

<Xincrement> Time in s

Usage: Query only

CALCulate:QMATH:DATA:XORigin?

Returns the time of the first sample of the indicated waveform. The command is relevant for data conversion, if binary data format is defined (FORM UINT,8|16|32).

Return values:

<Xorigin> Time in s

Usage: Query only

CALCulate:QMATH:DATA:YINCrement?

Returns the voltage value per bit of the indicated waveform. The command is relevant for data conversion, if binary data format is defined (FORM UINT,8|16|32).

Return values:

<Yincrement> Voltage in V

Usage: Query only

CALCulate:QMATH:DATA:YORigin?

Returns the voltage value for binary value 0 of the indicated waveform. The command is relevant for data conversion, if binary data format is defined (FORM UINT,8|16|32).

Return values:

<Yorigin> Voltage in V

Usage: Query only

CALCulate:QMAth:DATA:YRESolution?

Return the vertical bit resolution of the indicated waveform. The command is relevant for data conversion, if binary data format is defined (FORM UINT,8|16|32).

Return values:

<Yresolution> For default waveforms, the resolution is 8 bit.
If high resolution, average or filter are set, the resolution is 16 bit.

Usage: Query only

14.7.2 Reference Waveforms

| | |
|--------------------------------------|-----|
| REFCurve<m>:STATe..... | 231 |
| REFCurve<m>:SOURce..... | 231 |
| REFCurve<m>:SOURce:CATalog?..... | 232 |
| REFCurve<m>:UPDate..... | 232 |
| REFCurve<m>:SAVE..... | 232 |
| REFCurve<m>:LOAD..... | 233 |
| REFCurve<m>:LOAD:STATe..... | 233 |
| REFCurve<m>:HORizontal:SCALe..... | 233 |
| REFCurve<m>:HORizontal:POSition..... | 233 |
| REFCurve<m>:VERTical:SCALe..... | 234 |
| REFCurve<m>:VERTical:POSition..... | 234 |
| REFCurve<m>:DATA?..... | 234 |
| REFCurve<m>:DATA:HEADer?..... | 234 |
| REFCurve<m>:DATA:XINCrement?..... | 235 |
| REFCurve<m>:DATA:XORigin?..... | 235 |
| REFCurve<m>:DATA:YINCrement?..... | 235 |
| REFCurve<m>:DATA:YORigin?..... | 235 |
| REFCurve<m>:DATA:YRESolution?..... | 236 |

REFCurve<m>:STATe <State>

Displays or hides the selected reference waveform.

Suffix:

<m> 1..4
Selects the reference waveform, the internal reference storage.

Parameters:

<State> ON | OFF
*RST: OFF

REFCurve<m>:SOURce <Source>

Defines the source of the reference waveform.

Suffix:

<m> 1..4
Selects the reference waveform, the internal reference storage.

Parameters:

<Source> CH1 | CH2 | POD | QMA | RE1...RE4
CH1 | CH2
Signal channels 1 to 2.
POD
Logic POD.
QMA
Quick math channel.
RE1...RE4
Reference channels 1 to 4.
 *RST: CH1

REFCurve<m>:SOURce:CATalog?

Returns the source waveform - channel, math or reference waveform.

Suffix:

<m> 1..4
Selects the reference waveform, the internal reference storage.

Return values:

<Catalog> CH1 | CH2 | POD | QMA | RE1...RE4

Usage: Query only

REFCurve<m>:UPDate

Updates the selected reference by the waveform defined with [REFCurve<m>:SOURce](#).

Suffix:

<m> 1..4
Selects the reference waveform, the internal reference storage.

Usage: Event

REFCurve<m>:SAVE <FileName>

Stores the reference waveform the specified file.

Suffix:

<m> 1..4
Selects the reference waveform, the internal reference storage.

Setting parameters:

<FileName> String with path and file name

Usage: Setting only

REFCurve<m>:LOAD <FileName>

Loads the waveform data from the indicated reference file to the reference storage.

To load the instrument settings, use [REFCurve<m>:LOAD:STATE](#).

Suffix:

<m> 1..4
Selects the reference waveform, the internal reference storage.

Setting parameters:

<FileName> String with path and file name

Usage: Setting only

REFCurve<m>:LOAD:STATE

Loads the instrument settings in addition to the reference waveform data. The waveform data must be loaded before the settings, see [REFCurve<m>:LOAD](#).

The settings are only available if the file was stored to the internal storage /INT/REFERENCE and never written to an external storage (USB stick).

Suffix:

<m> 1..4
Selects the reference waveform.

Usage: Event

REFCurve<m>:HORIZontal:SCALE <Scale>

Changes the horizontal scale (timebase) of the reference waveform independent of the channel waveform settings.

Suffix:

<m> 1..4
Selects the reference waveform, the internal reference storage.

Parameters:

<Scale> Default unit: s/div

REFCurve<m>:HORIZontal:POSition <Position>

Changes the horizontal position of the reference waveform independent of the channel waveform settings.

Suffix:

<m> 1..4
Selects the reference waveform, the internal reference storage.

Parameters:

<Position> Default unit: s

REFCurve<m>:VERTical:SCALE <Scale>

Changes the vertical scale of the reference waveform.

Suffix:

<m> 1..4
Selects the reference waveform, the internal reference storage.

Parameters:

<Scale> Default unit: V/div

REFCurve<m>:VERTical:POSITION <Position>

Changes the vertical position of the reference waveform.

Suffix:

<m> 1..4
Selects the reference waveform, the internal reference storage.

Parameters:

<Position> Default unit: div

REFCurve<m>:DATA?

Returns the data of the reference waveform.

Suffix:

<m> 1..4
Selects the reference waveform, the internal reference storage.

Return values:

<Data> Comma-separated value list

Usage:

Query only

REFCurve<m>:DATA:HEADer?

Returns information on the reference waveform.

Table 14-3: Header data

| Position | Meaning | Example |
|----------|--|--------------------------|
| 1 | XStart in s | -9.477E-008 = - 94,77 ns |
| 2 | XStop in s | 9.477E-008 = 94,77 ns |
| 3 | Record length of the waveform in samples | 200000 |
| 4 | Number of values per sample interval, usually 1. | 1 |

Suffix:

<m> 1..4
Selects the reference waveform, the internal reference storage.

Parameters:

<Header> Comma-separated value list

Example: -9.477E-008,9.477E-008,200000,1

Usage: Query only

REFCurve<m>:DATA:XINCrement?

Returns the time difference between two adjacent samples of the indicated waveform. The commands are relevant for data conversion if binary data format is defined (FORM UINT, 8 | 16).

Suffix:

<m> 1..4
Selects the reference waveform, the internal reference storage.

Return values:

<Xincrement> Time in s

Usage: Query only

REFCurve<m>:DATA:XORigin?

Returns the time of the first sample of the indicated waveform. The commands are relevant for data conversion if binary data format is defined (FORM UINT, 8 | 16).

Suffix:

<m> 1..4
Selects the reference waveform, the internal reference storage.

Return values:

<Xorigin> Time in s

Usage: Query only

REFCurve<m>:DATA:YINCrement?

Returns the voltage value per bit of the indicated waveform. The commands are relevant for data conversion, if binary data format is defined (FORM UINT, 8 | 16).

Suffix:

<m> 1..4
Selects the reference waveform, the internal reference storage.

Return values:

<Yincrement> Voltage in V

Usage: Query only

REFCurve<m>:DATA:YORigin?

Returns the voltage value for binary value 0 of the indicated waveform. The commands are relevant for data conversion, if binary data format is defined (FORM UINT, 8 | 16).

| | |
|-----------------------|---|
| Suffix: | |
| <m> | 1..4
Selects the reference waveform, the internal reference storage. |
| Return values: | |
| <Yorigin> | Voltage in V |
| Usage: | Query only |

REFCurve<m>:DATA:YRESolution?

Returns the vertical bit resolution of the indicated waveform. The commands are relevant for data conversion, if binary data format is defined (FORM UINT, 8 | 16).

| | |
|-----------------------|--|
| Suffix: | |
| <m> | 1..4
Selects the reference waveform, the internal reference storage. |
| Return values: | |
| <Yresolution> | For default waveforms, the resolution is 8 bit. Its resolution is depending on the source waveform. The maximum is 16 bit. |
| Usage: | Query only |

14.8 FFT

In all CALCulate:MATH<m> commands, the numeric suffix <m> is irrelevant. You can omit it.

| | |
|---|-----|
| CALCulate:MATH<m>:ARITHmetics..... | 237 |
| CALCulate:MATH<m>:FFT:WINDow:TYPE..... | 237 |
| CALCulate:MATH<m>:FFT:AVERAge:COUNT..... | 238 |
| CALCulate:MATH<m>:FFT:MAGNitude:SCALE..... | 238 |
| CALCulate:MATH<m>:FFT:BANDwidth[:RESolution]:ADJusted?..... | 238 |
| CALCulate:MATH<m>:FFT:BANDwidth[:RESolution]:AUTO..... | 239 |
| CALCulate:MATH<m>:FFT:BANDwidth[:RESolution]:RATio..... | 239 |
| CALCulate:MATH<m>:FFT:BANDwidth[:RESolution][:VALue]..... | 239 |
| CALCulate:MATH<m>:FFT:CFRequency..... | 239 |
| CALCulate:MATH<m>:FFT:FULLspan..... | 239 |
| CALCulate:MATH<m>:FFT:SPAN..... | 239 |
| CALCulate:MATH<m>:FFT:STARt..... | 240 |
| CALCulate:MATH<m>:FFT:STOP..... | 240 |
| CALCulate:MATH<m>:FFT:TIME:RANGe..... | 240 |
| CALCulate:MATH<m>:FFT:TIME:POSition..... | 240 |
| CALCulate:MATH<m>:FFT:SRATe?..... | 240 |

CALCulate:MATH<m>:ARITHmetics <Arithmetics>

Defines the mode for FFT calculation and display.

Parameters:

<Arithmetics> OFF | ENVELOpe | AVERAge

OFF

The FFT is performed without any additional weighting or post-processing of the acquired data. The new input data is acquired and displayed, and thus overwrites the previously saved and displayed data.

ENVELOpe

In addition to the normal spectrum, the maximal oscillations are saved separately and updated for each new spectrum. The maximum values are displayed together with the newly acquired values and form an envelope. This envelope indicates the range of all FFT trace values that occurred.

AVERAge

The average of several spectrums is calculated. The number of spectrums used for the averaging is defined using the command. This mode is useful for noise rejection.

*RST: OFF

CALCulate:MATH<m>:FFT:WINDow:TYPE <WindowType>

Window functions are multiplied with the input values and thus can improve the FFT display.

Parameters:

<WindowType> RECTangular | HAMMING | HANN | BLACKharris | FLATtop2

RECTangular

The rectangular window multiplies all points by one. The result is a high frequency accuracy with thin spectral lines, but also with increased noise. Use this function preferably with pulse response tests where start and end values are zero.

HAMMING

The Hamming window is bell shaped. Its value is not zero at the borders of the measuring interval. Thus, the noise level inside the spectrum is higher than Hanning or Blackman, but smaller than the rectangular window. The width of the spectral lines is thinner than the other bellshaped functions. Use this window to measure amplitudes of a periodical signal precisely.

HANN

The Hann window is bell shaped. Unlike the Hamming window, its value is zero at the borders of the measuring interval. Thus, the noise level within the spectrum is reduced and the width of the spectral lines enlarges. Use this window to measure amplitudes of a periodical signal precisely.

BLACKmanharris

The Blackman window is bell shaped and has the steepest fall in its wave shape of all other available functions. Its value is zero at both borders of the measuring interval. In the Blackman window the amplitudes can be measured very precisely. However, determining the frequency is more difficult. Use this window to measure amplitudes of a periodical signal precisely.

FLATtop2

The flattop window has a poor frequency resolution, but the best amplitude accuracy and the sharpest side lobe. It is recommended for accurate single-tone amplitude measurements.

*RST: HANN

CALCulate:MATH<m>:FFT:AVERage:COUNT <AverageCount>

Defines the number of spectrums used for averaging if `CALCulate:MATH<m>:ARITHmetics` is set to `AVERage`.

Parameters:

<AverageCount> Integer value
 Range: 2 to 512
 *RST: 2

CALCulate:MATH<m>:FFT:MAGNitude:SCALE <Magnitude Scale>

Defines the scaling unit of the y-axis.

Parameters:

<Magnitude Scale> LINear | DBM | DBV
LINear
 Linear scaling; displays the RMS value of the voltage.
DBM
 logarithmic scaling; related to 1 mW
DBV
 logarithmic scaling; related to 1 Veff
 *RST: DBM

CALCulate:MATH<m>:FFT:BANDwidth[:RESolution]:ADJusted?

Returns the effective resolution bandwidth.

Return values:

<AdjResBW> Range: -100E+24 to 100E+24
 Default unit: Hz

Usage: Query only

CALCulate:MATH<m>:FFT:BANDwidth[:RESolution]:AUTO <SpanRBWCoupl>

Couples the frequency span to the RBW.

Parameters:

<SpanRBWCoupl> ON | OFF

CALCulate:MATH<m>:FFT:BANDwidth[:RESolution]:RATio <SpanRBWRatio>

Defines the ratio of resolution bandwidth (Hz) to span (Hz).

Parameters:

<SpanRBWRatio> Range: 2048 to 131072
*RST: 4096

CALCulate:MATH<m>:FFT:BANDwidth[:RESolution][:VALue] <ResolutionBW>

Defines the resolution bandwidth.

Parameters:

<ResolutionBW> Default unit: Hz

CALCulate:MATH<m>:FFT:CFRequency <CenterFreq>

Defines the position of the displayed frequency domain, which is (Center - Span/2) to (Center + Span/2). The width of the domain is defined using the [CALCulate:MATH<m>:FFT:SPAN](#) command.

Parameters:

<CenterFreq> Default unit: Hz

CALCulate:MATH<m>:FFT:FULLspan

Performs FFT calculation for the full frequency span.

Usage: Event

CALCulate:MATH<m>:FFT:SPAN <FreqSpan>

The span is specified in Hertz and defines the width of the displayed frequency range, which is (Center - Span/2) to (Center + Span/2). The position of the span is defined using the [CALCulate:MATH<m>:FFT:CFRequency](#) command.

Parameters:

<FreqSpan> Range: Depends on various other settings, mainly on time base and span/RBW ratio.
Increment: Only 1 | 2 | 5 in first digit
Default unit: Hz

| | |
|--------------------------------------|-----|
| MASK:SAVE..... | 242 |
| MASK:SOURce..... | 242 |
| MASK:CHCopy..... | 242 |
| MASK:YPOStion..... | 242 |
| MASK:YSCale..... | 242 |
| MASK:YWIDth..... | 243 |
| MASK:XWIDth..... | 243 |
| MASK:COUNT?..... | 243 |
| MASK:VCOunt?..... | 243 |
| MASK:DATA?..... | 244 |
| MASK:DATA:HEADer?..... | 244 |
| MASK:DATA:XINCrement?..... | 244 |
| MASK:DATA:XORigin?..... | 244 |
| MASK:DATA:YINCrement?..... | 244 |
| MASK:DATA:YORigin?..... | 245 |
| MASK:DATA:YRESolution?..... | 245 |
| MASK:ACTion:YOUT:ENABle..... | 245 |
| MASK:ACTion:SOUNd:EVENT:MODE..... | 245 |
| MASK:ACTion:STOP:EVENT:MODE..... | 245 |
| MASK:ACTion:PULSe:EVENT:MODE..... | 245 |
| MASK:ACTion:SCRSave:EVENT:MODE..... | 245 |
| MASK:ACTion:PRINt:EVENT:MODE..... | 245 |
| MASK:ACTion:WFMSave:EVENT:MODE..... | 245 |
| MASK:ACTion:STOP:EVENT:COUNT..... | 246 |
| MASK:ACTion:SCRSave:DESTination..... | 246 |
| MASK:ACTion:WFMSave:DESTination..... | 246 |
| MASK:RESet:COUNter..... | 246 |

MASK:STATe <State>

Turns the mask test mode on or off. When turning off, any temporarily stored new masks are deleted.

Parameters:

<State> ON | OFF
 *RST: OFF

MASK:TEST <Test>

Starts, finishes or interrupts a mask test.

Parameters:

<Test> RUN | STOP | PAUSE
 *RST: STOP

MASK:LOAD <FileName>

Loads a stored mask from the specified file.

Setting parameters:

<FileName> String parameter
 Path and file name

Usage: Setting only

MASK:SAVE <FileName>

Saves the current mask in the specified file.

Setting parameters:

<FileName> String parameter
 Path and file name

Usage: Setting only

MASK:SOURce <Source>

Defines the channel to be compared with the mask.

Parameters:

<Source> CH1 | CH2
 *RST: CH1

MASK:CHCopy

Creates a mask from the envelope waveform of the test source set with [MASK:SOURce](#)

.

Usage: Event

MASK:YPOSition <Yposition>

Moves the mask vertically within the display.

Parameters:

<Yposition> Mask offset from the vertical center
 Range: -200 to 200
 *RST: 0
 Default unit: div

MASK:YScale <Yscale>

Changes the vertical scaling to stretch or compress the mask in y-direction.

Parameters:

<Yscale> A value over 100 % stretches the amplitudes; a value less than 100 % compresses the amplitudes.

Range: 10 to 1000
 *RST: 100
 Default unit: %

MASK:YWIDTH <Yaddition>

Changes the width of the mask in vertical direction.

Parameters:

<Yaddition> The value is added to the y-values of the upper mask limit and subtracted from the y-values of the lower mask limit.

Range: 0 to 5.12
 *RST: 0
 Default unit: div

MASK:XWIDTH <Xaddition>

Changes the width of the mask in horizontal direction.

Parameters:

<Xaddition> The value is added to the positive x-values and subtracted from the negative x-values of the mask limits in relation to the mask center.

Range: 0 to 10
 *RST: 0
 Default unit: div

MASK:COUNT?

Returns the number of tested acquisitions.

Return values:

<TotalCount> Total number of tested acquisitions

Usage: Query only

MASK:VCOunt?

Returns the number of acquisitions that hit the mask.

Return values:

<ViolationCount> Acquisition count

Usage: Query only

MASK:DATA?

Returns the data of the mask.

Return values:

<Data> List of values

Usage: Query only

MASK:DATA:HEADer?

Returns information on the mask waveform.

Table 14-4: Header data

| Position | Meaning | Example |
|----------|---|-----------|
| 1 | XStart in s | 0.000E+00 |
| 2 | XStop in s | 5.990E+02 |
| 3 | Number of samples | 600 |
| 4 | Number of values per sample interval. For masks the value is 2. | 2 |

Return values:

<DataHeader> Comma-separated value list

Example: 0.000E+00,5.990E+02,600,2

Usage: Query only

MASK:DATA:XINCrement?

Return the time difference between two adjacent samples of the mask waveform.

Return values:

<Xincrement> Time in s

Usage: Query only

MASK:DATA:XORigin?

Return the time of the first sample of the indicated mask waveform.

Return values:

<Xorigin> Time in s

Usage: Query only

MASK:DATA:YINCrement?

Return the voltage value per bit of the indicated mask waveform.

Return values:

<Yincrement> Voltage in V

Usage: Query only

MASK:DATA:YORigin?

Return the voltage value for binary value 0 of the indicated mask waveform.

Return values:

<Yorigin> Voltage in V

Usage: Query only

MASK:DATA:YRESolution?

Return the vertical bit resolution of the indicated waveform.

Return values:

<Yresolution> For default waveforms, the resolution is 8 bit.

Usage: Query only

MASK:ACTion:YOUT:ENABLE <Yout>

Enable or disable of pulses at the AUX-OUTput if mask is violated.

Parameters:

<Yout> ON | OFF

*RST: OFF

MASK:ACTion:SOUND:EVENT:MODE <EventMode>**MASK:ACTion:STOP:EVENT:MODE <EventMode>****MASK:ACTion:PULSe:EVENT:MODE <EventMode>****MASK:ACTion:SCRSave:EVENT:MODE <EventMode>****MASK:ACTion:PRINT:EVENT:MODE <EventMode>****MASK:ACTion:WFMSave:EVENT:MODE <EventMode>**

Defines when and how often the action will be executed.

- **SOUND:** Generates a beep sound on mask violation.
- **STOP:** Stops the waveform acquisition on mask violation.
- **PULSe:** Emits an impulse.
- **SCRSave:** Saves a screenshot according to printer output settings.
- **PRINT:** Prints a screenshot to a printer connected to the USB connector on the front panel.
- **WFMSave:** Saves the waveform data according to the screenshot output settings.

Parameters:

<EventMode> OFF | EACH

OFF

No action is executed.

EACH

The selected action is executed on each violation of the mask.

*RST: OFF

MASK:ACTion:STOP:EVENT:COUNT <EventCount>

Sets the number of mask violations after which the action is executed.

Parameters:

<EventCount> Integer value, number of mask violations

MASK:ACTion:SCRSave:DESTination <File>

Defines the path and filename for a screenshot that will be saved on mask violation. The file format is PNG, the filename is incremented automatically

Parameters:

<File> String parameter

Example:

`MASK:ACT:SCRS:DEST "/USB_FRONT/MASKS/VIOL"`
 On first violation, the screenshot is saved to `VIOL.PNG`, on second violation to `VIOL01.PNG`, the third to `VIOL02.PNG` ...

MASK:ACTion:WFMSave:DESTination <File>

Defines the path and filename for a waveform data that will be saved on mask violation. The file format is CSV, the filename is incremented automatically

You can change the storage location, file name and/or file format manually in the [File] > "Waveforms" menu. Remote control uses the recent settings.

Parameters:

<File> String parameter

Example:

`MASK:ACT:WFMS:DEST "/USB_FRONT/MASKS/VIOL"`
 On first violation, the waveform data is saved to `VIOL.CSV`, on second violation to `VIOL01.CSV`, the third to `VIOL02.CSV` ...

MASK:RESet:COUNter

Sets the counters of passed and failed acquisitions to zero.

Usage: Event

14.10 Function Generator

| | |
|--------------------------------------|-----|
| GENerator:FUNctio..... | 247 |
| GENerator:VOLtag..... | 247 |
| GENerator:VOLtag:OFFset..... | 247 |
| GENerator:FREQuency..... | 247 |
| GENerator:FUNctio:RAMP:POLarity..... | 248 |
| GENerator:FUNctio:PULSe:DCYcle..... | 248 |
| GENerator:OUTPut[:ENABle]..... | 248 |

GENerator:FUNctio <Function>

Selects the generator function.

Parameters:

<Function> DC | SINusoid | SQUare | PULSe | TRIangle | RAMP
 *RST: SIN

GENerator:VOLtag <Amplitude>

Defines the amplitude value (peak-peak value) of the selected generator function.

Parameters:

<Amplitude> Range: 6.0000E-02 to 6.0000E+00
 *RST: 5.0000E-01
 Default unit: Vpp

GENerator:VOLtag:OFFset <Offset>

Sets the DC offset of the selected generator function.

Parameters:

<Offset> Range: -3.0000E+00 to 3.0000E+00
 *RST: 0.00E+00
 Default unit: V

GENerator:FREQuency <Frequency>

Defines the frequency value of the selected generator function.

Parameters:

<Frequency> Numeric value depending on the selected generator function.
 Range: 1.000E-01 to 5.000000000E+04 (sine / square)
 1.000E-01 to 1.000000000E+04 (triangle / ramp / pulse)
 *RST: 1.00000000E+03
 Default unit: Hz

GENERator:FUNction:RAMP:POLarity <Polarity>

Sets the polarity of the generator function ramp.

Parameters:

<Polarity> POSitive | NEGative
*RST: NEG

GENERator:FUNction:PULSe:DCYCLE <DutyCycle>

Defines the duty cycle value of the generator function pulse.

Parameters:

<DutyCycle> Range: 1.000E+01 to 9.000E+01
*RST: 2.500E+01
Default unit: %

GENERator:OUTPut[:ENABLE] <OutputEnable>

Activates or deactivates the function generator output.

Parameters:

<OutputEnable> ON | OFF
*RST: OFF

14.11 Pattern Generator

| | |
|---|-----|
| PGENERator:FUNction..... | 249 |
| PGENERator:PATtern:STATe..... | 249 |
| PGENERator:PATtern:STIME..... | 249 |
| PGENERator:PATtern:PERiod..... | 250 |
| PGENERator:PATtern:FREQuency..... | 250 |
| PGENERator:PATtern:ITIME..... | 250 |
| PGENERator:PATtern:BURSt:STATe..... | 250 |
| PGENERator:PATtern:BURSt:NCYCLE..... | 250 |
| PGENERator:PATtern:TRIGger:MODE..... | 251 |
| PGENERator:PATtern:TRIGger:SINGLE..... | 251 |
| PGENERator:PATtern:TRIGger:EXTern:SLOPe..... | 251 |
| PGENERator:PATtern:ARBITrary:DATA[:SET]..... | 251 |
| PGENERator:PATtern:ARBITrary:DATA:APPend..... | 252 |
| PGENERator:PATtern:ARBITrary:DATA:APPend:BOR..... | 252 |
| PGENERator:PATtern:ARBITrary:DATA:APPend:BAND..... | 252 |
| PGENERator:PATtern:ARBITrary:DATA:APPend:INDEX..... | 252 |
| PGENERator:PATtern:ARBITrary:DATA:LENGth..... | 252 |
| PGENERator:PATtern:COUNter:FREQuency..... | 253 |
| PGENERator:PATtern:COUNter:DIRectioN..... | 253 |

| | |
|--|-----|
| PGENerator:PATtern:SQUarewave:POLarity | 253 |
| PGENerator:PATtern:SQUarewave:DCYCLE | 253 |
| PGENerator:MANual:STATe<s> | 254 |

PGENerator:FUNCtion <Function>

Selects the pattern generator function.

Parameters:

<Function> SQUarewave | COUNter | ARBitrary | SPI | I2C | UART | CAN |
LIN | MANual

SQUarewave

Square wave function (e.g. for manual probe compensation).

COUNter

Definition of a 4 bit wide counter pattern.

ARBitrary

Definition of a 4 bit wide and 2048 samples deep pattern.

SPI

SPI BUS signals for measurements without measurement object. Data rate 100 kBit/s, 250 kBit/s or 1 MBit/s.

I2C

I²C BUS signals for measurements without measurement object. Data rate 100 kBit/s, 400 kBit/s, 1 MBit/s or 3.4 MBit/s.

UART

UART BUS signals for measurements without measurement object. Data rate 9600 Bit/s, 115.2 kBit/s and 1 MBit/s.

CAN

CAN BUS signals for measurements without measurement object up to 50 MBit/s.

LIN

LIN BUS signals for measurements without measurement object up to 50 MBit/s.

MANual

Manual pattern mode.

PGENerator:PATtern:STATe <State>

Activates or deactivates the pattern.

Parameters:

<State> ON | OFF
*RST: OFF

PGENerator:PATtern:STIME <SampleTime>

Defines the sample time of the pattern generator function.

Parameters:

<PatternCycles> Numeric value
 Range: 1 to 4096
 *RST: 1

PGENERator:PATtern:TRIGger:MODE <TriggerMode>

Defines the arbitrary trigger mode of the pattern generator function.

Parameters:

<TriggerMode> CONTinuous | SINGle | EXTern

CONTinuous

The CONT function (continuous trigger) issues the pattern continuously.

SINGle

If the SING setting is activated, the pattern is issued manually.

EXTern

For the EXT (external trigger) setting the pattern is issued by an edge at the external input of the oscilloscope (TRIG.EXT.).

*RST: CONT

PGENERator:PATtern:TRIGger:SINGle

Manual output of a pattern (single trigger).

Usage: Event

PGENERator:PATtern:TRIGger:EXTern:SLOPe <Slope>

Defines the slope of the external arbitrary pattern trigger.

Parameters:

<Slope> POSitive | NEGative | EITHer

POSitive

Rising edge (rise).

NEGative

Falling edge (fall).

EITHer

Rising as well as the falling edge (both).

*RST: POS

PGENERator:PATtern:ARBItrary:DATA[:SET] <ArbitraryData>

Defines the arbitrary pattern.

Parameters:

<ArbitraryData> List of values

Example: `PGEN:PATT:ARB:DATA 0,1,1,1,2,0,3,1,4,0`

PGENerator:PATTern:ARBbitrary:DATA:APPend <AppendData>

Defines the arbitrary pattern.

Parameters:

<AppendData> List of Values

Example:

`PGEN:PATT:ARB:DATA:APP 4`

From index = n the oscilloscope appends a 4 in HEX to the pattern.

Usage:

Setting only

PGENerator:PATTern:ARBbitrary:DATA:APPend:BOR <AppendData>

Parameters:

<AppendData> List of values

From index = n data will be integrated in existing pattern via OR combination.

PGENerator:PATTern:ARBbitrary:DATA:APPend:BAND <AppendData>

Selects the pattern generator function.

Parameters:

<AppendData> List of values

From index = n data will be integrated in existing pattern via AND combination.

PGENerator:PATTern:ARBbitrary:DATA:APPend:INDex <AppendIndex>

Defines the index of the arbitrary pattern.

Parameters:

<Function> Numeric value

Example:

`PGEN:PATT:ARB:DATA:APP:IND 5`

`PGEN:PATT:ARB:DATA:APP 4`

From index = n a pattern length of 6 will be defined with last high bit 4.

PGENerator:PATTern:ARBbitrary:DATA:LENGth <PatternLength>

Defines the arbitrary pattern length.

Parameters:

<PatternLength> Numeric value
 Range: 1 to 2048
 *RST: 1

PGENERator:PATtern:COUNter:FREQuency <Period>

Defines the frequency value of the pattern generator counter function. The user frequency always refers to the switching of the pattern condition. This results in square waveforms for individual pins.

| Pin | Frequency |
|-----|-----------|
| S0 | f/2 |
| S1 | f/4 |
| S2 | f/8 |
| S3 | f/16 |

Parameters:

<Period> Numeric value
 Range: 2.380952425301E-02 to 2.500000000000E+07
 *RST: 1.000000000000E+05

PGENERator:PATtern:COUNter:DIRection <CountDirection>

Sets the pattern generator counter direction.

Parameters:

<CountDirection> UPWard | DOWNward
 *RST: UPW

PGENERator:PATtern:SQUarewave:POLarity <Polarity>

Defines the polarity of the pattern generator square wave function.

Parameters:

<Polarity> NORMal | INVerted
 *RST: NORM

PGENERator:PATtern:SQUarewave:DCYCLE <DutyCycle>

Selects the pattern generator function.

Parameters:

<DutyCycle> Numeric value
 Range: 1.00E+00 to 9.900E+01
 *RST: 5.000E+01
 Default unit: %

Example:

PGEN:PATT:SQU:DCYC 20
 Sets the duty cycle of the square wave function to 20 %.

PGenerator:MANual:STATe<s> <State>**Suffix:**

<s> 0..3
 Selects the pins S0 to S3 manually.

Parameters:

<Function> ON | OFF
ON
 Pin state is set to high (H).
OFF
 Pin state is set to low (L).
 *RST: OFF

Example:

PGEN:MAN:STAT2 ON
 Pin state of s2 is set to high (H).

14.12 Digital Voltmeter

| | |
|--------------------------------|-----|
| DVM<m>:TYPE..... | 254 |
| DVM<m>:SOURce..... | 255 |
| DVM:ENABle..... | 255 |
| DVM<m>:RESult[:ACTual]? | 255 |
| DVM<m>:RESult[:ACTual]:STATus? | 256 |
| DVM<m>:RESult:RESet..... | 256 |
| DVM:POSition..... | 256 |

DVM<m>:TYPE <MeasurementType>

Selects the measurement type of the digital voltmeter function.

Suffix:

<m> 1..2
 Selects the channel resp. the secondary measurement type.

Parameters:

<MeasurementType> MEAN | DCRMs | STDD | UPEakvalue | LPEakvalue | PEAK |
 CRES t | OFF
MEAN
 DC

DCRMs

RMS

STDD

Standard deviation

UPEakvalue

Peak +

LPEakvalue

Peak -

PEAK

Peak peak value (Maximum-Minimum)

CREStCrest factor ($|X|_{\max}/X_{\text{RMS}}$)**OFF**

Measurement display deactivated

Example:

DVM1:TYPE PEAK

Selects the DVM type PEAK for channel 1 (CH1).

DVM<m>:SOURce <Source>

Selects the source for the digital voltmeter function.

- DVM1 = primary measurement value CH1
- DVM2 = secondary measurement value CH1
- DVM3 = primary measurement value CH2
- DVM4 = secondary measurement value CH2

Suffix:

<m>

1..2

Selects the channel resp. the secondary measurement type.

Parameters:

<Source>

CH1 | CH2

Example:

DVM2:SOUR CH2

DVM:ENABle <VoltmeterEnable>

Activates or deactivates the digital voltmeter function.

Parameters:

<VoltmeterEnable>

ON | OFF

*RST:

OFF

DVM<m>:RESult[:ACTual]?

Returns the current value of the indicated measurement.

Return values:

<CurrentValue> Numeric value

Example:

```
DVM2:SOUR CH2
DVM2:TYPE DCRM
DVM2:RES?
<-- 7.089E-01
```

A RMS measurement is performed on measurement place 2, on channel 2. The result is 708,9 mV.

Usage:

Query only

DVM<m>:RESult[:ACTual]:STATus?

Returns the result value and the status of the result.

The status is the decimal representation of a 4-bit register value:

- Bit 0 = 1: result is valid
- Bit 1 = 1: no result available
- Bit 2 = 1: clipping occurs
- Bit 3 = 1: no period found

Return values:

<ResultAndStatus> <Value>,Status

Example:

```
DVM:SOUR CH1
DVM:TYPE MEAN
DVM:RES:STAT?
<-- 4.968E-01,5
```

The result value of the mean measurement on channel 1 is 496.1 mV. The result status is 5 (decimal) = 0101 (binary). That means, the result is valid (bit 0 = 1), and the signal is clipped by the limits of the ADC range (bit 3 = 1).

Usage:

Query only

DVM<m>:RESult:RESet

Resets the digital voltmeter function.

Suffix:

<m> 1..2
Selects the channel resp. the secondary measurement type.

Usage:

Event

DVM:POSition <Position>

Selects the display position of the digital voltmeter values.

Parameters:

<Position> TLEFt | TRIGht | BLEFt | BRIGht

TLEFt

Display position top left.

TRIGHt

Display position top right.

BLEFt

Display position bottom left.

BRIGHt

Display position bottom right.

*RST: TLEF

14.13 Counter

| | |
|---|-----|
| TCOunter:ENAB | 257 |
| TCOunter:RESult[:ACTual]:FREQuency? | 257 |
| TCOunter:RESult[:ACTual]:PERiod? | 257 |

TCOunter:ENAB <Enable>

Enables or disables the trigger counter measurements.

Parameters:

<Enable> ON | OFF
*RST: OFF

TCOunter:RESult[:ACTual]:FREQuency?

Returns the frequency of the trigger source.

Return values:

<FrequencyValue> Default unit: Hz

Usage: Query only

TCOunter:RESult[:ACTual]:PERiod?

Returns the period of the trigger source.

Return values:

<PeriodValue> Default unit: s

Usage: Query only

14.14 Component Tester

| | |
|---|-----|
| COMPOnenttest:STATe | 258 |
| COMPOnenttest:FREQuency | 258 |

COMPONENTtest:STATe <State>

Switches the component tester mode on or off.

Parameters:

<State> ON | OFF
 *RST: OFF

COMPONENTtest:FREQuency <Frequency>

Sets the frequency of the component tester source.

Parameters:

<Frequency> F50 | F200
 F50
 50 Hz
 F200
 200 Hz

14.15 External input

| | |
|-------------------------------|-----|
| EXTern[:STATe]..... | 258 |
| EXTern:POSition..... | 259 |
| EXTern:COUPling..... | 259 |
| EXTern:SIZE..... | 259 |
| EXTern:THReshold..... | 259 |
| EXTern:TYPE..... | 259 |
| EXTern:DATA?..... | 260 |
| EXTern:DATA:POINts..... | 260 |
| EXTern:DATA:HEADer?..... | 261 |
| EXTern:DATA:XINCrement?..... | 261 |
| EXTern:DATA:XORigin?..... | 261 |
| EXTern:DATA:YINCrement?..... | 261 |
| EXTern:DATA:YORigin?..... | 262 |
| EXTern:DATA:YRESolution?..... | 262 |

EXTern[:STATe] <State>

Activates or deactivates the external input functionality.

Parameters:

<State> ON | OFF
 Default unit: OFF

EXTern:POSition <Position>

Sets the vertical position of the external input signal and its horizontal axis in the window.

Parameters:

<Position> Position value, given in divisions.
Range: -4 to 4
Default unit: div

EXTern:COUPLing <Coupling>

Selects the connection of the external input signal.

Parameters:

<Coupling> DC | AC
*RST: DC

EXTern:SIZE <Size>

Defines the display size of the external input signal.

Parameters:

<Size> SMAL | MEDium | LARGe
Default unit: SMAL

EXTern:THReshold <Threshold>

Defines the threshold level. If the signal value is higher than the threshold, the signal state is high (1 or true for the boolean logic). Otherwise, the signal state is considered low (0 or false), if the signal value is below the threshold.

Parameters:

<Threshold> Range: -5.49 to 5.49
*RST: V
Default unit: 4.90E-01

EXTern:TYPE <DecimationMode>

Selects the method to reduce the data stream of the ADC to a stream of waveform points with lower sample rate.

Parameters:

<DecimationMode> SAMPlE | PDEtect | HRESolution

SAMPlE

Input data is acquired with a sample rate which is aligned to the time base (horizontal scale) and the record length.

PDETECT

The minimum and the maximum of n samples in a sample interval are recorded as waveform points (Peak Detect).

HRESOLUTION

The average of n sample points is recorded as waveform point (High Resolution).

*RST: SAMP

EXTern:DATA?

Returns the data of the external input signal waveform. To set the export format, use `FORMat[:DATA]`. To set the range of samples to be returned, use `EXTern:DATA:POINTs`

Return values:

<Data> List of values according to the format settings - the voltages of recorded waveform samples.

Usage: Query only

EXTern:DATA:POINTs <Points>

As a setting, the command selects a range of samples. As a query, it returns the number of samples for the selected range. To get correct results with settings MAX and DMAX, the acquisition must not run when the command is used. To acquire consistent and valid data, use the SINGle command before. Do not cancel a running acquisition with STOP because the waveform data might be incomplete or incorrect.

Setting parameters:

<Points> DEFault | MAXimum | DMAXimum
Sets the range for the query.

DEFault

Waveform samples displayed on the screen.

MAXimum

Range is the complete memory.

Note: Reading the complete memory is only possible in STOP mode, and if maximum sample rate is set (`ACQuire:WRATe ACQ:WRAT MSAM`)

DMAXimum (Display Maximum)

Number of samples in the current waveform record.

Return values:

<Points> Number of data points in the selected range (samples).

Example:

```
EXT:DATA:POIN MAX
EXT:DATA:POIN?
Suffix: 20000
```

EXTern:DATA:HEADer?

Returns information on the external input signal waveform.

Table 14-5: Header data

| Position | Meaning | Example |
|----------|--|--------------------------|
| 1 | XStart in s | -9.477E-008 = - 94,77 ns |
| 2 | XStop in s | 9.477E-008 = 94,77 ns |
| 3 | Record length of the waveform in Samples | 20000 |
| 4 | Number of values per sample interval, usually 1. | 1 |

Return values:

<Header> Comma-separated value list.

Example: -9.477E-008,9.477E-008,20000,1

Usage: Query only

EXTern:DATA:XINCrement? <Xincrement>

Returns the time difference between two adjacent samples of the indicated waveform. The command is relevant for data conversion, if binary data format is defined (FORM UINT,8|16|32).

Parameters:

<Xincrement> Time in s

Usage: Query only

EXTern:DATA:XORigin? <Xorigin>

Returns the time of the first sample of the indicated waveform. The command is relevant for data conversion, if binary data format is defined (FORM UINT,8|16|32).

Parameters:

<Xorigin> Time in s

Usage: Query only

EXTern:DATA:YINCrement? <Yincrement>

Returns the voltage value per bit of the indicated waveform. The command is relevant for data conversion, if binary data format is defined (FORM UINT,8|16|32).

Parameters:

<Yincrement> Voltage in V

Usage: Query only

EXTern:DATA:YORigin? <Yorigin>

Returns the voltage value for binary value 0 of the indicated waveform. The command is relevant for data conversion, if binary data format is defined (FORM UINT,8|16|32).

Parameters:

<Yorigin> Voltage in V

Usage: Query only

EXTern:DATA:YRESolution? <Yresolution>

Returns the voltage value for binary value 0 of the indicated waveform. The command is relevant for data conversion, if binary data format is defined (FORM UINT,8|16|32).

Parameters:

<Yresolution> For default waveforms, the resolution is 8 bit.
If high resolution, average or filter are set, the resolution is 16 bit.

Usage: Query only

14.16 Protocol Analysis

| | |
|---|-----|
| • General | 262 |
| • Parallel / Parallel Clocked Bus | 265 |
| • SPI Bus | 267 |
| • SSPI Bus | 274 |
| • I²C Bus | 276 |
| • UART | 287 |
| • CAN | 293 |
| • LIN | 305 |

14.16.1 General

| | |
|--|-----|
| BUS:STATe | 262 |
| BUS:TYPE | 263 |
| BUS:FORMat | 263 |
| BUS:DSIZe | 263 |
| BUS:DSIGNals | 263 |
| BUS:POSition | 264 |
| BUS:LABel | 264 |
| BUS:LABel:STATe | 264 |

BUS:STATe <State>

Switches the protocol display on or off.

Suffix:

 1, 2
Selects the bus.

Parameters:

<State> ON | OFF
*RST: OFF

BUS:TYPE <Type>

Defines the bus or interface type for analysis. For most types, a special option to the instrument is required.

Suffix:

 1, 2
Selects the bus.

Parameters:

<Type> PARAllel | CPARAllel | I2C | SPI | SSPI | UART | CAN | LIN
*RST: PARAllel

BUS:FORMat <Format>

Sets the decoding format for the display on the screen.

Suffix:

 1, 2
Selects the bus.

Parameters:

<Format> ASCii | HEXadecimal | BINary | DECimal
*RST: HEX

BUS:DSIZe <DisplaySize>

Sets the height of the decoded bus signal on the screen.

Suffix:

 1..4
Selects the bus.

Parameters:

<DisplaySize> **SMAL**I | **MED**ium | **LARG**e
*RST: MEDium

BUS:DSIGNals <BitsSignals>

Displays the individual bit lines above the decoded bus line.

Suffix:

 1, 2
Selects the bus.

Parameters:

<BitsSignals> ON | OFF
*RST: ON

BUS:POSition <Position>

Sets the vertical position of the decoded bus signal in divisions on the screen.

Suffix:

 1, 2
Selects the bus.

Parameters:

<Position> Range: -4 to 4
*RST: 1
Default unit: div

BUS:LABel <Label>

Defines an additional name label for the selected bus.

Suffix:

 1, 2
Selects the bus.

Parameters:

<Label> String value
The maximum name length is 8 characters, and only ASCII characters provided on the on-screen keyboard can be used.

BUS:LABel:STATe <State>

Displays or hides the bus label. The bus label is shown on the the right side of the display.

Suffix:

 1, 2
Selects the bus.

Parameters:

<State> ON | OFF
*RST: ON

14.16.2 Parallel / Parallel Clocked Bus

| | |
|--------------------------------------|-----|
| BUS:PARAllel:DATA<m>:SOURce..... | 265 |
| BUS:PARAllel:WIDTh..... | 265 |
| BUS:CPARAllel:DATA<m>:SOURce..... | 265 |
| BUS:CPARAllel:CLOCK:SOURce..... | 266 |
| BUS:CPARAllel:CLOCK:SLOPe..... | 266 |
| BUS:CPARAllel:CS:SOURce..... | 266 |
| BUS:CPARAllel:CS:POLarity..... | 267 |
| BUS:CPARAllel:WIDTh..... | 267 |

BUS:PARAllel:DATA<m>:SOURce <DataSource>

Defines the digital channel that is assigned to the selected bit. Use the command for each bit of the bus.

Suffix:

 1, 2
Selects the bus.

<m> Selects the bit line

Parameters:

<DataSource> D0 D7
*RST: D0

Example:

```
BUS:PAR:WIDTh 4
BUS:PAR:DATA0:SOUR D2
BUS:PAR:DATA1:SOUR D3
BUS:PAR:DATA2:SOUR D4
BUS:PAR:DATA3:SOUR D5
```

BUS:PARAllel:WIDTh <BusWidth>

Sets the number of lines to be analyzed.

Suffix:

 1, 2
Selects the bus.

Parameters:

<BusWidth> Range: 1 to 6
Increment: 1
*RST: 6
Default unit: Bit

BUS:CPARAllel:DATA<m>:SOURce <DataSource>

Defines the digital channel that is assigned to the selected bit.

Use the command for each bit of the bus.

Suffix:

 1, 2
Selects the bus.

<m> Selects the bit line

Parameters:

<Source> D0 D7
*RST: D0

Example:

```
BUS:CPAR:WIDT 4
BUS:CPAR:DATA0:SOUR D2
BUS:CPAR:DATA1:SOUR D3
BUS:CPAR:DATA2:SOUR D4
BUS:CPAR:DATA3:SOUR D5
```

BUS:CPARallel:CLOCK:SOURce <ClockSource>

Selects the digital channel that is used as clock line.

Suffix:

 1, 2
Selects the bus.

Parameters:

<ClockSource> D0...D7
*RST: D7

BUS:CPARallel:CLOCK:SLOPe <ClockSlope>

Selects if the data is sampled on the rising or falling slope of the clock, or on both edges (EITHER). The clock slope marks the begin of a new bit.

Suffix:

 1, 2
Selects the bus.

Parameters:

<ClockSlope> POSitive | NEGative | EITHER

BUS:CPARallel:CS:SOURce <ChipSelectSource>

Selects the digital channel that is used as chip select line.

Suffix:

 1, 2
Selects the parallel bus.

Parameters:

<ChipSelectSource> D0...D7
*RST: D6

BUS:CPARAllel:CS:POLarity <Polarity>

Selects whether the chip select signal is high active (high = 1) or low active (low = 1).

Suffix:

 1, 2
Selects the bus.

Parameters:

<Polarity> POSitive | NEGative
POSitive
high active
NEGative
low active

BUS:CPARAllel:WIDTh <BusWidth>

Sets the number of lines to be analyzed.

Suffix:

 1, 2
Selects the bus.

Parameters:

<BusWidth> Range: 1 to 6
Increment: 1
*RST: 6
Default unit: Bit

14.16.3 SPI Bus

- [SPI - Configuration](#).....267
- [Trigger](#).....270
- [Decode](#).....271

14.16.3.1 SPI - Configuration

| | |
|---|-----|
| BUS:SPI:CS:SOURce | 267 |
| BUS:SPI:CS:POLarity | 268 |
| BUS:SPI:CLOCK:SOURce | 268 |
| BUS:SPI:CLOCK:POLarity | 268 |
| BUS:SPI:DATA:SOURce | 269 |
| BUS:SPI:DATA:POLarity | 269 |
| BUS:SPI:BORDER | 269 |
| BUS:SPI:SSIZe | 269 |

BUS:SPI:CS:SOURce <Source>

Selects the input channel of the chip select line.

Suffix:

 1, 2
Selects the bus.

Parameters:

<Source> CH1 | CH2 | D0 D7 | EXTErn
*RST: EXT

BUS:SPI:CS:POLarity <Polarity>

Selects whether the chip select signal is high active (high = 1) or low active (low = 1).

Suffix:

 1, 2
Selects the bus.

Parameters:

<Polarity> POSitive | NEGative
POSitive
High active
NEGative
Low active
*RST: POSitive

BUS:SPI:CLOCK:SOURce <Source>

Selects the input channel of the clock line.

Suffix:

 1, 2
Selects the bus.

Parameters:

<Source> CH1 | CH2 | D0 D7
*RST: CH1

BUS:SPI:CLOCK:POLarity <Polarity>

Selects if data is stored with the rising or falling slope of the clock. The slope marks the begin of a new bit.

Suffix:

 1, 2
Selects the bus.

Parameters:

<Polarity> POSitive | NEGative
POSitive
Rising slope

NEGative
 Falling slope
 *RST: NEGative

BUS:SPI:DATA:SOURce <Source>

Selects the input channel of the data line.

Suffix:
 1, 2
 Selects the bus.

Parameters:
 <Source> CH1 | CH2 | D0 D7
 *RST: CH1

BUS:SPI:DATA:POLarity <Polarity>

Selects whether transmitted data is high active (high = 1) or low active (low = 1) on the data line.

Suffix:
 1, 2
 Selects the bus.

Parameters:
 <Polarity> POSitive | NEGative
POSitive
 High active
NEGative
 Low active
 *RST: POSitive

BUS:SPI:BORDER <BitOrder>

Defines if the data of the messages starts with MSB (most significant bit) or LSB (least significant bit).

Suffix:
 1, 2
 Selects the bus.

Parameters:
 <BitOrder> MSBFirst | LSBFirst
 *RST: MSBFirst

BUS:SPI:SSIZE <SymbolSize>

Sets the word length, the number of bits in a message.

Suffix:

 1, 2
Selects the bus.

Parameters:

<SymbolSize> Range: 4 to 32
Increment: 1
*RST: 8
Default unit: Bit

14.16.3.2 Trigger

| | |
|---|-----|
| TRIGger:A:SPI:MODE | 270 |
| TRIGger:A:SPI:PATtern | 270 |
| TRIGger:A:SPI:PLENght | 271 |
| TRIGger:A:SPI:POFFset | 271 |

TRIGger:A:SPI:MODE <Mode>

Specifies the trigger mode for SPI/SSPI protocols.

Parameters:

<Mode> BStart | BEND | NTHBit | PATtern

BStart

Burst start, sets the trigger event to the start of the frame. The frame starts when the chip select signal CS changes to the active state.

BEND

Burst end, sets the trigger event to the end of the message.

NTHBit

Sets the trigger event to the specified bit number. To define the bit number, use [TRIGger:A:SPI:POFFset](#).

PATtern

Sets the trigger event to a serial pattern. To define the pattern, use [TRIGger:A:SPI:PATtern](#).

For a complete configuration of the pattern mode, you also have to set [TRIGger:A:SPI:PLENght](#) and [TRIGger:A:SPI:POFFset](#).

*RST: BStart

TRIGger:A:SPI:PATtern <DataPattern>

Defines the bit pattern as trigger condition. The pattern length is limited, see [TRIGger:A:SPI:PLENght](#) on page 271.

Parameters:

<DataPattern> String with max. 32 bit. Characters 0, 1, and X are allowed.

Example: TRIG:A:SPI:PATT "0011XXXX0110"
Sets a 12-bit pattern.

TRIGger:A:SPI:PLENgtH <PatternLength>

Defines how many bits build up the serial pattern.

Parameters:

<PatternLength> Range: 1 to 32
 Increment: 1
 *RST: 4

Example: TRIG:A:SPI:PATT "0011XXXX0110"
TRIG:A:SPI:PLEN?
12
TRIG:A:SPI:PLEN 4
TRIG:A:SPI:PATT?
"0011"

TRIGger:A:SPI:POFFset <PatternBitOffset>

Sets the number of bits before the first bit of the pattern.

Parameters:

<PatternBitOffset> Number of ignored bits.
 Range: 0 to 4095
 Increment: 1
 *RST: 0

14.16.3.3 Decode

| | |
|------------------------------------|-----|
| BUS:SPI:FCOunt? | 271 |
| BUS:SPI:FRAME<n>:STATus? | 272 |
| BUS:SPI:FRAME<n>:STARt? | 272 |
| BUS:SPI:FRAME<n>:STOP? | 272 |
| BUS:SPI:FRAME<n>:DATA? | 273 |
| BUS:SPI:FRAME<n>:WCOunt? | 273 |
| BUS:SPI:FRAME<n>:WORD<o>:STARt? | 273 |
| BUS:SPI:FRAME<n>:WORD<o>:STOP? | 274 |
| BUS:SPI:FRAME<n>:WORD<o>:MISO? | 274 |
| BUS:SPI:FRAME<n>:WORD<o>:MOSI? | 274 |

BUS:SPI:FCOunt?

Returns the number of frames.

Suffix:

 1, 2
 Selects the bus.

Return values:

<FrameCount> Total number of decoded frames.

Usage: Query only

BUS:SPI:FRAME<n>:STATus?

Returns the status of frames.

Suffix:

 1, 2
Selects the bus.

<n> Selects the frame.

Return values:

<Status> OK | INCFIRST | INCLAST | INSUFFICIENT

OK

Frame is o.k.

INCFIRST

First frame is incomplete

INCLAST

Last frame is incomplete

INSUFFICIENT

Frame is insufficient

Usage: Query only

BUS:SPI:FRAME<n>:START?

Returns the start time of the specified frame.

Suffix:

 1, 2
Selects the bus.

<n> Selects the frame.

Return values:

<StartTime> Range: depends on sample rate and time base
Default unit: s

Usage: Query only

BUS:SPI:FRAME<n>:STOP?

Returns the end time of the specified frame.

Suffix:

 1, 2
Selects the bus.

<n> Selects the frame.

Return values:

<StopTime> Range: depends on sample rate and time base
 Default unit: s

Usage: Query only

BUS:SPI:FRAME<n>:DATA?

Returns the comma separated frame data.

Suffix:

 1, 2
 Selects the bus.

<n> Selects the frame.

Return values:

<Data> List of decimal values of data bytes

Example: BUS : SPI : FRAM3 : DATA?

Usage: Query only

BUS:SPI:FRAME<n>:WCOunt?

Returns the number of words in the specified frame.

Suffix:

 1, 2
 Selects the bus.

<n> Selects the frame.

Return values:

<WordCount> Number of words

Usage: Query only

BUS:SPI:FRAME<n>:WORD<o>:START?

Returns the start time of the specified data word.

Suffix:

 1, 2
 Selects the bus.

<n> Selects the frame.

<o> Selects the word number.

Return values:

<StartTime> Range: depends on sample rate and time base
 Default unit: s

Usage: Query only

BUS:SPI:FRAME<n>:WORD<o>:STOP?

Returns the end time of the specified data word.

Suffix:

| | |
|-----|--------------------------|
| | 1, 2
Selects the bus. |
| <n> | Selects the frame. |
| <o> | Selects the word number. |

Return values:

| | |
|------------|--|
| <StopTime> | Range: depends on sample rate and time base
Default unit: s |
|------------|--|

Usage: Query only

BUS:SPI:FRAME<n>:WORD<o>:MISO?**BUS:SPI:FRAME<n>:WORD<o>:MOSI?**

Returns the data value of the specified word.

Suffix:

| | |
|-----|---------------------------------|
| | 1, 2
Selects the bus. |
| <n> | Selects the frame (1...n) |
| <o> | Selects the word number (1...m) |

Return values:

| | |
|--------|--------------------------------|
| <Data> | Decimal value of the data word |
|--------|--------------------------------|

Usage: Query only

14.16.4 SSPI Bus

| | |
|---------------------------------|-----|
| BUS:SSPI:CLOCK:SOURce..... | 274 |
| BUS:SSPI:CLOCK:POLarity..... | 275 |
| BUS:SSPI:DATA:SOURce..... | 275 |
| BUS:SSPI:DATA:POLarity..... | 275 |
| BUS:SSPI:BITime..... | 276 |
| BUS:SSPI:BORDER..... | 276 |
| BUS:SSPI:SSIZe..... | 276 |

BUS:SSPI:CLOCK:SOURce <Source>

Selects the input channel of the clock line.

Suffix:

| | |
|-----|--------------------------|
| | 1, 2
Selects the bus. |
|-----|--------------------------|

Parameters:

<Source> CH1 | CH2 | D0 D7
 *RST: CH1

BUS:SSPI:CLOCK:POLarity <Polarity>

Selects if data is stored with the rising or falling slope of the clock. The slope marks the begin of a new bit.

Suffix:

 1, 2
 Selects the bus.

Parameters:

<Polarity> POSitive | NEGative
POSitive
 Rising slope
NEGative
 Falling slope
 *RST: POSitive

BUS:SSPI:DATA:SOURce <Source>

Selects the input channel of the data line.

Suffix:

 1, 2
 Selects the bus.

Parameters:

<Source> CH1 | CH2 | D0 D7
 *RST: CH1

BUS:SSPI:DATA:POLarity <Polarity>

Selects whether transmitted data is high active (high = 1) or low active (low = 1) on the data line.

Suffix:

 1, 2
 Selects the bus.

Parameters:

<Polarity> POSitive | NEGative
POSitive
 High active
NEGative
 Low active
 *RST: POSitive

BUS:SSPI:BITime <BurstIdleTime>

Within the idle time the data and clock lines are low. A new frame begins when the idle time has expired and the clock line has been inactive during that time. If the time interval between the data words is shorter than the idle time, the words are part of the same frame.

Suffix:

 1, 2
Selects the bus.

Parameters:

<BurstIdleTime> Range: 16E-9 to 1E-3
*RST: 100e-6
Default unit: s

BUS:SSPI:BORDER <BitOrder>

Defines if the data of the messages starts with MSB (most significant bit) or LSB (least significant bit).

Suffix:

 1, 2
Selects the bus.

Parameters:

<BitOrder> MSBFirst | LSBFirst
*RST: MSBFirst

BUS:SSPI:SSIZE <SymbolSize>

Sets the word length, the number of bits in a message.

Suffix:

 1, 2
Selects the bus.

Parameters:

<SymbolSize> Range: 4 to 32
*RST: 8
Default unit: Bit

14.16.5 I²C Bus

- [I²C - Configuration](#).....277
- [Trigger](#).....278
- [Decode](#).....280

14.16.5.1 I²C - Configuration

| | |
|------------------------------|-----|
| BUS:I2C:CLOCK:SOURce..... | 277 |
| BUS:I2C:DATA:SOURce..... | 277 |
| BUS:I2C:AMODE..... | 277 |

BUS:I2C:CLOCK:SOURce <Source>

Sets the input channel to which the clock line is connected.

Suffix:

 1, 2
Selects the bus.

Parameters:

<Source> CH1 | CH2 | D0 D7
*RST: CH1

BUS:I2C:DATA:SOURce <Source>

Sets the input channel to which the data line is connected.

Suffix:

 1, 2
Selects the bus.

Parameters:

<Source> CH1 | CH2 | D0 D7
*RST: CH1

BUS:I2C:AMODE <BusConfig>

Defines if the R/W bit of a 7-bit address is considered separately or as part of the address. The setting defines which address lengths are available with [TRIGger:A:I2C:MODE](#)

Suffix:

 1, 2
Selects the bus.

Parameters:

<BusConfig> ARWRite | AONLy
ARWRite
Address + R/W bit
AONLy
Address only
*RST: AONL

14.16.5.2 Trigger

| | |
|----------------------------|-----|
| TRIGger:A:I2C:MODE..... | 278 |
| TRIGger:A:I2C:ACCess..... | 278 |
| TRIGger:A:I2C:AMODe..... | 279 |
| TRIGger:A:I2C:ADDRess..... | 279 |
| TRIGger:A:I2C:PATtern..... | 279 |
| TRIGger:A:I2C:PLENght..... | 279 |
| TRIGger:A:I2C:POFFset..... | 280 |

TRIGger:A:I2C:MODE <Mode>

Specifies the trigger mode for I²C.

Parameters:

<Mode>

START | REStart | STOP | MACKnowledge | PATtern

START

Start of the message. The start condition is a falling slope on SDA while SCL is high.

REStart

Restarted message. The restart is a repeated start condition.

STOP

End of the message. The stop condition is a rising slope on SDA while SCL is high.

MACKnowledge

Missing acknowledge. If the transfer failed, at the moment of the acknowledge bit the SCL and the SDA lines are both on high level.

PATtern

Triggers on a set of trigger conditions: read or write access of the master, to an address, or/and to a bit pattern in the message.

For a complete configuration of the pattern mode, you have to set:

TRIGger:A:I2C:ACCess (read/write access), and

TRIGger:A:I2C:AMODe and TRIGger:A:I2C:ADDRess

(address), and/or

TRIGger:A:I2C:POFFset and TRIGger:A:I2C:PLENght

and TRIGger:A:I2C:PATtern (pattern)

*RST: START

TRIGger:A:I2C:ACCess <Access>

Toggles the trigger condition between Read and Write access of the master.

Parameters:

<Access>

READ | WRITe

*RST: READ

TRIGger:A:I2C:AMODe <AdrMode>

Sets the length of the slave address.

Parameters:

| | |
|-----------|--------------------------|
| <AdrMode> | NORMAL EXTENDED |
| | NORMAL: 7 bit address |
| | EXTENDED: 10 bit address |
| *RST: | NORMAL |

TRIGger:A:I2C:ADDRESS <AddressString>

Sets the address of the slave device. The address can have 7 bits or 10 bits.

Parameters:

| | |
|-----------------|---|
| <AddressString> | String with max. 7 or 10 characters, depending on the address length. Characters 0, 1, and X are allowed. |
|-----------------|---|

Example: TRIG:A:I2C:ADDR "10X1"

TRIGger:A:I2C:PATtern <DataPattern>

Defines the bit pattern as trigger condition.

Parameters:

| | |
|---------------|--|
| <DataPattern> | String with max. 24 characters (3 byte) . Characters 0, 1, and X are allowed. If you define a pattern shorter than the pattern length, the missing LSB are filled with X. If you define a pattern longer than the pattern length, the pattern string is not valid. |
|---------------|--|

Example:

```
TRIG:A:I2C:PLEN 2
TRIG:A:I2C:PATT "10X10000XXXX1111"
TRIG:A:I2C:PATT?
Return value (2 bytes): "10X10000XXXX1111"
```

Example:

```
TRIG:A:I2C:PLEN 1
TRIG:A:I2C:PATT "110"
TRIG:A:I2C:PATT?
Return value (1 byte): "110XXXXX"
```

TRIGger:A:I2C:PLENght <PatternLength>

Defines how many bytes are considered in the trigger condition. To set the pattern for these bytes, use [TRIGger:A:I2C:PATtern](#).

Parameters:

| | |
|-----------------|-----------------|
| <PatternLength> | Number of bytes |
| Range: | 1 to 3 |
| Increment: | 1 |
| *RST: | 1 |

TRIGger:A:I2C:POFFset <PatternByteOffset>

Sets the number of bytes before the first byte of interest, relating to the end of the address bytes.

Parameters:

<PatternByteOffset> Number of ignored bytes
 Range: 0 to 4095
 Increment: 1
 *RST: 0

14.16.5.3 Decode

| | |
|---------------------------------------|-----|
| BUS:I2C:FCOunt? | 280 |
| BUS:I2C:FRAMe<n>:STATus? | 280 |
| BUS:I2C:FRAMe<n>:STARt? | 281 |
| BUS:I2C:FRAMe<n>:STOP? | 281 |
| BUS:I2C:FRAMe<n>:ACCess? | 282 |
| BUS:I2C:FRAMe<n>:AMODE? | 282 |
| BUS:I2C:FRAMe<n>:AACcess? | 282 |
| BUS:I2C:FRAMe<n>:ADDRess? | 283 |
| BUS:I2C:FRAMe<n>:ADEVice? | 283 |
| BUS:I2C:FRAMe<n>:ASTart? | 283 |
| BUS:I2C:FRAMe<n>:ADBStart? | 284 |
| BUS:I2C:FRAMe<n>:ACOMplete? | 284 |
| BUS:I2C:FRAMe<n>:BCOunt? | 284 |
| BUS:I2C:FRAMe<n>:DATA? | 285 |
| BUS:I2C:FRAMe<n>:BYTE<o>:VALue? | 285 |
| BUS:I2C:FRAMe<n>:BYTE<o>:STARt? | 286 |
| BUS:I2C:FRAMe<n>:BYTE<o>:ACKStart? | 286 |
| BUS:I2C:FRAMe<n>:BYTE<o>:ACCess? | 286 |
| BUS:I2C:FRAMe<n>:BYTE<o>:COMPLete? | 287 |

BUS:I2C:FCOunt?

Returns the number of received frames.

Suffix:

 1, 2
 Selects the bus.

Return values:

<FrameCount> Total number of decoded frames.

Usage: Query only

BUS:I2C:FRAMe<n>:STATus?

Returns the overall state of the frame.

Suffix:

 1, 2
Selects the bus.

<n> Selects the frame.

Return values:

<State> INComplete | OK | UNEXpstop | INSufficient | ADDifferent

INComplete

The frame is not completely contained in the acquisition.

OK

The frame is o.k.

UNEXpstop

The frame stop is unexpected.

INSufficient

The frame is insufficient.

ADDifferent

The frame is different.

Usage: Query only

BUS:I2C:FRAME<n>:START?

Returns the start time of the specified frame.

Suffix:

 1, 2
Selects the bus.

<n> Selects the frame.

Return values:

<StartTime> Range: depends on sample rate and time base
Default unit: s

Usage: Query only

BUS:I2C:FRAME<n>:STOP?

Returns the end time of the specified frame.

Suffix:

 1, 2
Selects the bus.

<n> Selects the frame.

Return values:

<EndTime> Range: depends on sample rate and time base
Default unit: s

Usage: Query only

BUS:I2C:FRAMe<n>:ACcEss?

Returns the transfer direction - read or write access from master to slave.

Suffix:

 1, 2
Selects the bus.

<n> Selects the frame.

Return values:

<Access> INComplete | READ | WRITE | EITHer | UNDF

INComplete

The frame is incomplete.

READ

read frame

WRITE

write frame

EITHer

Either write or read frame.

UNDF

The frame is undefined.

Usage: Query only

BUS:I2C:FRAMe<n>:AMODe?

Returns the address mode.

Suffix:

 1, 2
Selects the bus.

<n> Selects the frame.

Return values:

<AddressMode> BIT7 | BIT10

BIT7

7 Bit address

BIT10

10 Bit address

Usage: Query only

BUS:I2C:FRAMe<n>:AACcEss?

Returns the address acknowledge bit value for the indicated frame.

Suffix:

 1, 2
Selects the bus.

| | |
|-----------------------|--|
| <n> | Selects the frame. |
| Return values: | |
| <Acknowledge> | INComplete ACK NACK EITHer |
| | INComplete
Acknowledge is incomplete |
| | ACK
Acknowledge |
| | NACK
No Acknowledge |
| | EITHer
ACK or NACK |
| Usage: | Query only |

BUS:I2C:FRAMe<n>:ADDRess?

Returns the decimal address value of the indicated frame **including** the R/W bit.

Suffix:

| | |
|-----------------------|---|
| | 1, 2
Selects the bus. |
| <n> | Selects the frame. |
| Return values: | |
| <AddressValue> | Decimal value
Range: 0 to 2047
Increment: 1 |
| Usage: | Query only |

BUS:I2C:FRAMe<n>:ADEVice?

Returns the decimal address value of the indicated frame **without** R/W bit.

Suffix:

| | |
|-----------------------|---|
| | 1, 2
Selects the bus. |
| <n> | Selects the frame. |
| Return values: | |
| <SlaveAddress> | Decimal value
Range: 0 to 1023
Increment: 1 |
| Usage: | Query only |

BUS:I2C:FRAMe<n>:ASTart?

Returns the start time of the address for the indicated frame.

Suffix:

 1, 2
Selects the bus.

<n> *
Selects the frame.

Return values:

<StartTime> Range: depends on sample rate, and time base
Default unit: s

Usage: Query only

BUS:I2C:FRAMe<n>:ADBStart?

Returns the start time of the address acknowledge bit.

Suffix:

 1, 2
Selects the bus.

<n> Selects the frame.

Return values:

<AckStartTime> Range: depends on sample rate, and time base
Default unit: s

Usage: Query only

BUS:I2C:FRAMe<n>:ACOMplete?

Returns the state of the address.

Suffix:

 1, 2
Selects the bus.

<n> Selects the frame.

Return values:

<AddressComplete> ON | OFF
ON
Address was received completely.
OFF
Address was not received completely.

Usage: Query only

BUS:I2C:FRAMe<n>:BCOunt?

Returns the number of data bytes of a frame.

Suffix:

 1, 2
Selects the bus.

<n> Selects the frame.

Return values:

<ByteCountInFrame> Number of words (bytes)

Example: BUS:I2C:FRAM2:BCO?
-> 4

Usage: Query only

BUS:I2C:FRAMe<n>:DATA?

Returns the data words of the specified frame.

Suffix:

 1, 2
Selects the bus.

<n> Selects the frame.

Return values:

<DataWordsInFrame>Comma-separated list of decimal values of the data bytes.

Example: BUS:I2C:FRAM2:DATA?
returns four data bytes:
-> 69,158,174,161

Usage: Query only

BUS:I2C:FRAMe<n>:BYTE<o>:VALue?

Returns the decimal value of the specified byte.

Suffix:

 1, 2
Selects the bus.

<n> Selects the frame.

<o> Selects the byte number.

Return values:

<ByteValue> Decimal value
Range: 0 to 255
Increment: 1

Example: BUS:I2C:FRAM2:BYTE2:VAL?
-> 158

Usage: Query only

BUS:I2C:FRAMe<n>:BYTE<o>:STARt?

Returns the start time of the specified data byte.

Suffix:

| | |
|-----|--------------------------|
| | 1, 2
Selects the bus. |
| <n> | Selects the frame. |
| <o> | Selects the byte number. |

Return values:

| | |
|-------------|---|
| <StartTime> | Range: depends on sample rate, and time base
Default unit: s |
|-------------|---|

| | |
|---------------|------------|
| Usage: | Query only |
|---------------|------------|

BUS:I2C:FRAMe<n>:BYTE<o>:ACKStart?

Returns the start time of the acknowledge bit of the specified byte.

Suffix:

| | |
|-----|--------------------------|
| | 1, 2
Selects the bus. |
| <n> | Selects the frame. |
| <o> | Selects the byte number. |

Return values:

| | |
|----------------|---|
| <AckStartTime> | Range: depends on sample rate, and time base
Default unit: s |
|----------------|---|

| | |
|---------------|------------|
| Usage: | Query only |
|---------------|------------|

BUS:I2C:FRAMe<n>:BYTE<o>:ACCess?

Returns the acknowledge bit value of the specified data byte.

Suffix:

| | |
|-----|--------------------------|
| | 1, 2
Selects the bus. |
| <n> | Selects the frame. |
| <o> | Selects the byte number. |

Return values:

| | |
|---------------|----------------------------------|
| <Acknowledge> | INComplete ACK NACK EITHer |
|---------------|----------------------------------|

INComplete

Acknowledge is incomplete

ACK

Acknowledge

NACK

No Acknowledge

EITHer

ACK or NACK

Usage: Query only**BUS:I2C:FRAMe<n>:BYTE<o>:COMPLete?**

Returns the information whether a data byte of a frame is received complete.

Suffix:

| | |
|-----|--------------------------|
| | 1, 2
Selects the bus. |
| <n> | Selects the frame. |
| <o> | Selects the byte number. |

Return values:

| | |
|----------------|--|
| <ByteComplete> | ON OFF |
| ON | Data byte was received completely. |
| OFF | Data byte was not received completely. |

Usage: Query only**14.16.6 UART**

- [UART - Configuration](#).....287
- [Trigger](#).....289
- [Decode](#).....291

14.16.6.1 UART - Configuration

| | |
|---|-----|
| BUS:UART:DATA:SOURce | 287 |
| BUS:UART:DATA:POLarity | 288 |
| BUS:UART:SSIZe | 288 |
| BUS:UART:PARity | 288 |
| BUS:UART:SBIT | 289 |
| BUS:UART:BAUDrate | 289 |
| BUS:UART:BITime | 289 |

BUS:UART:DATA:SOURce <Source>

Selects the input channel of the UART signal.

Suffix:

 1, 2
 Selects the bus.
 Note: SPI/SSPI and UART protocols occupy two bus lines.

Parameters:

<Source> CH1 | CH2 | D0 D7
 *RST: CH1

BUS:UART:DATA:POLarity <Polarity>

Defines if the transmitted data on the bus is high (high = 1) or low (low = 1) active.

Suffix:

 1, 2
 Selects the bus.

Parameters:

<Polarity> POSitive | NEGative
POSitive
 High active
NEGative
 Low active
 *RST: POS

BUS:UART:SSIZE <SymbolSize>

Sets the number of data bits in a message.

Suffix:

 1, 2
 Selects the bus.

Parameters:

<SymbolSize> Range: 5 to 9
 Increment: 1
 *RST: 8
 Default unit: Bit

BUS:UART:PARity <Parity>

Defines the optional parity bit that is used for error detection.

Suffix:

 1, 2
 Selects the bus.

Parameters:

<Parity> ODD | EVEN | NONE
 *RST: NONE

BUS:UART:SBIT <StopBitNumber>

Sets the stop bits.

Suffix:

 1, 2
 Selects the bus.

Parameters:

<StopBitNumber> B1 | B1_5 | B2
 1; 1.5 or 2 stop bits are possible.
*RST: B1

BUS:UART:BAUDrate <Baudrate>

Sets the number of transmitted bits per second.

Suffix:

 1, 2
 Selects the bus.

Parameters:

<Baudrate> Range: 6.0E+01 to 1.56E+07
 *RST: 1.15200E+05
 Default unit: Bit

BUS:UART:BITime <BurstIdleTime>

Sets the minimal time between two data frames (packets), that is, between the last stop bit and the start bit of the next frame.

Suffix:

 1, 2
 Selects the bus.

Parameters:

<BurstIdleTime> Range: 9.54880E-05 to 2.6843137E-01
 *RST: 1.1458333E-03
 Default unit: s

14.16.6.2 Trigger

| | |
|-----------------------------|-----|
| TRIGger:A:UART:MODE..... | 290 |
| TRIGger:A:UART:PATtern..... | 290 |
| TRIGger:A:UART:PLENght..... | 290 |
| TRIGger:A:UART:POFFset..... | 291 |

TRIGger:A:UART:MODE <Mode>

Specifies the trigger mode for UART/RS-232 interfaces.

Parameters:

<Mode>

BStart | SBIT | NTHSymbol | SYMBol | PATtern | PERRor | FERRor | BREak

BStart

Burst start. Sets the trigger to the begin of a data frame. The frame start is the first start bit after the idle time.

SBIT

Start bit. The start bit is the first low bit after a stop bit.

NTHSymbol

Sets the trigger to the n-th symbol of a burst.

SYMBol

Triggers if a pattern occurs in a symbol at any position in a burst.

PATtern

Triggers on a serial pattern at a defined position in the burst.

To define the pattern, use [TRIGger:A:UART:PLENgtH](#) and [TRIGger:A:UART:PATtern](#).

To define the position, use [TRIGger:A:UART:POFFset](#) on page 291.

PRERror

Parity Error: Triggers if a bit error occurred in transmission.

FERRor

Triggers on frame error.

BREak

Triggers if a start bit is not followed by a stop bit within a defined time. During the break the stop bits are at low state.

*RST: SBIT

TRIGger:A:UART:PATtern <DataPattern>

Defines the bit pattern as trigger condition.

Parameters:

<DataPattern>

Binary pattern with max. 32 bit. Characters 0, 1, and X are allowed.

*RST: 1 = "00000001"

TRIGger:A:UART:PLENgtH <PatternLength>

Defines how many symbols build up the serial pattern.

Parameters:

| | |
|-----------------|-------------------|
| <PatternLength> | Number of symbols |
| | Range: 1 to 3 |
| | Increment: 1 |
| | *RST: 1 |

TRIGger:A:UART:POFFset <PatternByteOffset>

Sets the number of symbols before the first symbol of the pattern.

Parameters:

| | |
|---------------------|---------------------------|
| <PatternByteOffset> | Number of ignored symbols |
| | Range: 0 to 4095 |
| | Increment: 1 |
| | *RST: 0 |

14.16.6.3 Decode

| | |
|-------------------------------------|-----|
| BUS:UART:FCOunt? | 291 |
| BUS:UART:FRAMe<n>:WCOunt? | 291 |
| BUS:UART:FRAMe<n>:WORD<o>:VALue? | 292 |
| BUS:UART:FRAMe<n>:WORD<o>:START? | 292 |
| BUS:UART:FRAMe<n>:WORD<o>:STOP? | 292 |
| BUS:UART:FRAMe<n>:WORD<o>:STATe? | 292 |

BUS:UART:FCOunt?

Returns the number of frames.

Suffix:

| | |
|-----|------------------|
| | 1, 2 |
| | Selects the bus. |

Return values:

| | |
|--------------|---------------------------------|
| <FrameCount> | Total number of decoded frames. |
|--------------|---------------------------------|

Usage: Query only

BUS:UART:FRAMe<n>:WCOunt?

Returns the number of words of a frame.

Suffix:

| | |
|-----|--------------------|
| | 1, 2 |
| | Selects the bus. |
| <n> | Selects the frame. |

Return values:

| | |
|-------------|---------------------------------------|
| <WordCount> | Number of words (symbols, characters) |
|-------------|---------------------------------------|

Usage: Query only

BUS:UART:FRAME<n>:WORD<o>:VALue?**Suffix:**

| | |
|-----|--------------------------|
| | 1, 2
Selects the bus. |
| <n> | Selects the frame. |
| <o> | Selects the word number. |

Return values:

| | |
|---------|--|
| <Value> | Decimal value
Range: 0 to 511
Increment: 1 |
|---------|--|

Usage: Query only

BUS:UART:FRAME<n>:WORD<o>:START?**Suffix:**

| | |
|-----|--------------------------|
| | 1, 2
Selects the bus. |
| <n> | Selects the frame. |
| <o> | Selects the word number. |

Return values:

| | |
|-------------|--|
| <StartTime> | Range: depends on sample rate and time base
Default unit: s |
|-------------|--|

Usage: Query only

BUS:UART:FRAME<n>:WORD<o>:STOP?**Suffix:**

| | |
|-----|--------------------------|
| | 1, 2
Selects the bus. |
| <n> | Selects the frame. |
| <o> | Selects the word number. |

Return values:

| | |
|------------|--|
| <StopTime> | Range: depends on sample rate and time base
Default unit: s |
|------------|--|

Usage: Query only

BUS:UART:FRAME<n>:WORD<o>:STATE?**Suffix:**

| | |
|-----|--------------------------|
| | 1, 2
Selects the bus. |
|-----|--------------------------|

| | |
|-----------------------|--|
| <n> | Selects the frame. |
| <o> | Selects the word number. |
| Return values: | |
| <Status> | OK FRSTart FRENd FRMError STERror SPERror PRERror INSufficient |
| | OK
Frame is o.k. |
| | FRSTart
Frame start |
| | FRENd
Frame end |
| | FRMError
Frame error |
| | STERror
Startbit error |
| | SPERror
Stopbit error |
| | PRERror
Parity error |
| | INSufficient
Frame is insufficient |
| | *RST: OK |
| Usage: | Query only |

14.16.7 CAN

- [CAN - Configuration](#).....293
- [Trigger](#).....295
- [Decode](#).....298

14.16.7.1 CAN - Configuration

| | |
|--|-----|
| BUS:CAN:DATA:SOURce | 293 |
| BUS:CAN:TYPE | 294 |
| BUS:CAN:SAMPlepoint | 294 |
| BUS:CAN:BITRate | 294 |

BUS:CAN:DATA:SOURce <Source>

Sets the input channel to which the data line is connected.

Suffix:

| | |
|-----|------------------|
| | 1, 2 |
| | Selects the bus. |

Parameters:

<Source> CH1 | CH2 | D0 D7
 *RST: CH1

BUS:CAN:TYPE <SignalType>

Sets the signal type of the CAN.

Suffix:

 1, 2
 Selects the bus.

Parameters:

<SignalType> CANH | CANL
CANH
 CAN High
CANL
 CAN Low
 *RST: CANH

BUS:CAN:SAMPlEpoint <SamplePoint>

Sets the sample point for the CAN Decoder within the bit period.

Suffix:

 1, 2
 Selects the bus.

Parameters:

<SamplePoint> Range: 25 to 90
 Increment: 1
 *RST: 50
 Default unit: %

BUS:CAN:BITRate <BitRate>

Sets the user defined bit rate for the CAN Decoder.

Suffix:

 1, 2
 Selects the bus.

Parameters:

<BitRate> Range: 1.00E+02 to 1.0081E+06
 *RST: 5.0000E+04
 Default unit: Bit/s

14.16.7.2 Trigger

| | |
|-------------------------------|-----|
| TRIGger:A:CAN:TYPE..... | 295 |
| TRIGger:A:CAN:FTYPE..... | 295 |
| TRIGger:A:CAN:ITYPE..... | 296 |
| TRIGger:A:CAN:ICONdition..... | 296 |
| TRIGger:A:CAN:IDENtifier..... | 296 |
| TRIGger:A:CAN:DCONdition..... | 297 |
| TRIGger:A:CAN:DATA..... | 297 |
| TRIGger:A:CAN:DLENgth..... | 297 |
| TRIGger:A:CAN:ACKError..... | 297 |
| TRIGger:A:CAN:CRCError..... | 298 |
| TRIGger:A:CAN:FORMError..... | 298 |
| TRIGger:A:CAN:BITSterror..... | 298 |

TRIGger:A:CAN:TYPE <TriggerType>

Specifies the trigger mode for CAN.

Parameters:

<TriggerType> STOframe | EOFframe | ID | IDDT | FTYPE | ERRCondition

STOframe

Sets the trigger to the start of a frame.

EOFframe

Sets the trigger to the end of a frame.

ID

Sets the trigger to the ID of a frame.

IDDT

Sets the trigger to the ID and data of a frame.

FTYPE

Sets the trigger to the frame type.

ERRCondition

Sets the trigger to the error condition of a frame.

*RST: STOF

TRIGger:A:CAN:FTYPE <FrameType>

Specifies the frame type for CAN.

Parameters:

<FrameType> DATA | REMote | ERRor | OVERload | ANY

DATA

Sets the frame type to data.

REMote

Sets the frame type to remote.

ERRor

Sets the frame type to error.

OVERload

Sets the frame type to overload.

ANY

Sets the frame type to any.

*RST: ERR

TRIGger:A:CAN:ITYPE <IdentifierType>

Selects the length of the identifier: 11 bit for CAN base frames, or 29 bits for CAN extended frames. The command is relevant if `TRIGger:A:CAN:TYPE` is set to ID or IDDT.

Parameters:

<IdentifierType> B11 | B29

B11

Sets the identifier type 11Bit.

B29

Sets the identifier type 29Bit.

*RST: B11

TRIGger:A:CAN:ICONdition <IdentifierCondition>

Specifies the condition for the identifier.

Parameters:

<IdentifierCondition> EQUual | NEQual | GTHan | LTHan

EQUual

Sets the condition for identifier to equal.

NEQual

Sets the condition for identifier to not equal.

GTHan

Sets the condition for identifier to greater than.

LTHan

Sets the condition for identifier to less than.

*RST: EQU

TRIGger:A:CAN:IDENTifier <Identifier>

Specifies the identifier, depending of `TRIGger:A:CAN:ITYPE` setting only string with 11 or 29 characters is possible.

Parameters:

<Identifier> String containing binary pattern with max. 29 bit. Characters 0, 1, and X are allowed.

TRIGger:A:CAN:DCondition <DataCondition>

Specifies the condition for the data.

Parameters:

<DataCondition> EQUal | NEQual | GTHan | LTHan

EQUal

Sets the condition for identifier to equal.

NEQual

Sets the condition for identifier to not equal.

GTHan

Sets the condition for identifier to greater than.

LTHan

Sets the condition for identifier to less than.

*RST: EQU

TRIGger:A:CAN:DATA <Data>

Specifies the data for CAN trigger. Depending of [TRIGger:A:CAN:DLENgth](#) setting the number of characters is fixed, all bytes need to be complete.

Parameters:

<Data> String containing binary pattern with max. 64 bit. Characters 0, 1, and X are allowed. Make sure to enter complete bytes.

Example: TRIG:A:CAN:DATA "10010110"

TRIGger:A:CAN:DLENgth <DataLength>

Specifies the data length for the CAN trigger.

Parameters:

<DataLength> Range: 0 to 8
 Increment: 1
 *RST: 1
 Default unit: Byte

TRIGger:A:CAN:ACKerror <AcknowledgeError>

Specifies the trigger on acknowledge error when trigger type is set to error, using [TRIGger:A:CAN:TYPE](#). An acknowledgement error occurs when the transmitter does not receive an acknowledgement - a dominant bit during the Ack Slot.

Parameters:

<AcknowledgeError> ON | OFF
 *RST: OFF

TRIGger:A:CAN:CRCError <CRCError>

Specifies the trigger on checksum error when trigger type is set to error, using [TRIGger:A:CAN:TYPE](#).

Parameters:

<CRCError> ON | OFF
 *RST: OFF

TRIGger:A:CAN:FORMError <FormError>

Specifies the trigger on form error when trigger type is set to error, using [TRIGger:A:CAN:TYPE](#). A form error occurs when a fixed-form bit field contains one or more illegal bits.

Parameters:

<FormError> ON | OFF
 *RST: OFF

TRIGger:A:CAN:BITSterror <BitStuffingError>

Specifies the trigger on stuff bit error when trigger type is set to error, using [TRIGger:A:CAN:TYPE](#).

Parameters:

<BitStuffingError> ON | OFF
 *RST: ON

14.16.7.3 Decode

| | |
|--|-----|
| BUS:CAN:FCOunt? | 299 |
| BUS:CAN:FRAME<n>:STATus? | 299 |
| BUS:CAN:FRAME<n>:START? | 299 |
| BUS:CAN:FRAME<n>:STOP? | 300 |
| BUS:CAN:FRAME<n>:TYPE? | 300 |
| BUS:CAN:FRAME<n>:DATA? | 300 |
| BUS:CAN:FRAME<n>:ACKState? | 301 |
| BUS:CAN:FRAME<n>:CSState? | 301 |
| BUS:CAN:FRAME<n>:DLCState? | 301 |
| BUS:CAN:FRAME<n>:IDState? | 302 |
| BUS:CAN:FRAME<n>:ACKValue? | 302 |
| BUS:CAN:FRAME<n>:CSValue? | 302 |
| BUS:CAN:FRAME<n>:DLCValue? | 303 |
| BUS:CAN:FRAME<n>:IDType? | 303 |
| BUS:CAN:FRAME<n>:IDValue? | 303 |
| BUS:CAN:FRAME<n>:BSEPosition? | 304 |
| BUS:CAN:FRAME<n>:BCOunt? | 304 |
| BUS:CAN:FRAME<n>:BYTE<o>:STATE? | 304 |
| BUS:CAN:FRAME<n>:BYTE<o>:VALue? | 305 |

BUS:CAN:FCOunt?

Returns the number of received frames.

Suffix:

 1, 2
 Selects the bus.

Return values:

<FrameCount> Total number of decoded frames.

Usage: Query only

BUS:CAN:FRAME<n>:STATus?

Returns the overall state of the specified frame.

Suffix:

 1, 2
 Selects the bus.

<n> Selects the frame (1...n).

Return values:

<FrameStatus> OK | BTST | CRC | FORM | NACK | INSufficient

OK

Frame is valid.

BTST

Bit stuff error occurred.

CRC

Cyclic redundancy check failed.

FORM

Wrong CRC, ACK delimiter or end of frame occurred.

NACK

Acknowledge is missing.

INSufficient

Frame is incomplete.

Usage: Query only

BUS:CAN:FRAME<n>:START?

Returns the start time of the specified frame.

Suffix:

 1, 2
 Selects the bus.

<n> Selects the frame (1...n).

Return values:

<StartTime> Range: depends on sample rate, and time base
 Default unit: s

Usage: Query only

BUS:CAN:FRAME<n>:STOP?

Returns the end time of the specified frame.

Suffix:

 1, 2
 Selects the bus.

<n> Selects the frame (1...n).

Return values:

<StopTime> Range: depends on sample rate, and time base
 Default unit: s

Usage: Query only

BUS:CAN:FRAME<n>:TYPE?

Returns the type of the specified frame.

Suffix:

 1, 2
 Selects the bus.

<n> Selects the frame (1...n).

Return values:

<FrameType> DATA | REMote | ERR | OVLD

DATA

Frame type is data.

REMote

Frame type is remote.

ERR

Frame type is error.

OVLD

Frame type is overload.

Usage: Query only

BUS:CAN:FRAME<n>:DATA?

Returns a comma separated list of decimal values.

Suffix:

 1, 2
 Selects the bus.

<n> Selects the frame (1...n).

Return values:

<FrameData> Comma-separated list of decimal values of the data bytes.

Usage: Query only

BUS:CAN:FRAMe<n>:ACKState?

Returns the state of the acknowledge field.

Suffix:

 1, 2
Selects the bus.

<n> Selects the frame (1...n).

Return values:

<AcknowledgeState> OK | UNDF
OK
Acknowledge state is o.k.
UNDF
Acknowledge state is undefined.

Usage: Query only

BUS:CAN:FRAMe<n>:CSState?

Returns the state of the checksum.

Suffix:

 1, 2
Selects the bus.

<n> Selects the frame (1...n).

Return values:

<ChecksumState> OK | UNDF
OK
Checksum state is o.k.
UNDF
Checksum is undefined.

Usage: Query only

BUS:CAN:FRAMe<n>:DLCState?

Returns the state of the data length code.

Suffix:

 1, 2
Selects the bus.

<n> Selects the frame (1...n).

Return values:

<DLCState> OK | UNDF

OK
Data length code state is o.k.

UNDF
Data length code state is undefined.

Usage: Query only

BUS:CAN:FRAME<n>:IDState?

Returns the state of the identifier.

Suffix:

 1, 2
Selects the bus.

<n> Selects the frame (1...n).

Return values:

<IdentifierState> OK | UNDF

OK
Identifier state is o.k.

UNDF
Identifier state is undefined.

Usage: Query only

BUS:CAN:FRAME<n>:ACKValue?

Returns the value of the acknowledge field.

Suffix:

 1, 2
Selects the bus.

<n> Selects the frame (1...n).

Return values:

<AcknowledgeValue> Decimal value

Usage: Query only

BUS:CAN:FRAME<n>:CSValue?

Returns the checksum value.

Suffix:

 1, 2
Selects the bus.

<n> Selects the frame (1...n).

Return values:

<ChecksumValue> Decimal value

Usage: Query only

BUS:CAN:FRAME<n>:DLCValue?

Returns the value of the data length code field of a frame.

Suffix:

 1, 2
Selects the bus.

<n> Selects the frame (1...n).

Return values:

<DLCValue> Non-negative integer

Usage: Query only

BUS:CAN:FRAME<n>:IDType?

Returns the length of the identifier: 11 bit for CAN base frames, or 29 bits for CAN extended frames.

Suffix:

 1, 2
Selects the bus.

<n> Selects the frame (1...n).

Return values:

<IdentifierType> B11 | B29

B11

Identifier type is 11 bit

B29

Identifier type is 29 bit

Usage: Query only

BUS:CAN:FRAME<n>:IDValue?

Returns the decimal address value of the specified frame.

Suffix:

 1, 2
Selects the bus.

<n> Selects the frame (1...n).

Return values:

<IdentifierValue> Decimal value

Usage: Query only

BUS:CAN:FRAME<n>:BSEPosition?

Returns the position of the bit stuffing error in the specified frame (if available).

Suffix:

 1, 2
Selects the bus.

<n> Selects the frame (1...n).

Return values:

<ErrorPosition> *RST: 0
Default unit: s

Usage: Query only

BUS:CAN:FRAME<n>:BCOunt?

Returns the number of data bytes in the specified frame.

Suffix:

 1, 2
Selects the bus.

<n> Selects the frame (1...n).

Return values:

<ByteCount> Number of words (bytes)

Usage: Query only

BUS:CAN:FRAME<n>:BYTE<o>:STATe?

Returns the state of the specified data byte.

Suffix:

 1, 2
Selects the bus.

<n> Selects the frame (1...n).

<o> Selects the byte number (1...n).

Return values:

<ByteStatus> OK | UNDF
OK
Data byte state is o.k.
UNDF
Data byte state is undefined.

Usage: Query only

BUS:CAN:FRAMe<n>:BYTE<o>:VALue?

Returns the decimal value of the specified byte.

Suffix:

| | |
|-----|----------------------------------|
| | 1, 2
Selects the bus. |
| <n> | Selects the frame (1...n). |
| <o> | Selects the byte number (1...n). |

Return values:

<ByteValue> Decimal value

Usage: Query only

14.16.8 LIN

- [LIN - Configuration](#)..... 305
- [Trigger](#)..... 306
- [Decode](#)..... 309

14.16.8.1 LIN - Configuration

| | |
|--|-----|
| BUS:LIN:DATA:SOURce | 305 |
| BUS:LIN:POLarity | 305 |
| BUS:LIN:STANdard | 306 |
| BUS:LIN:BITRate | 306 |

BUS:LIN:DATA:SOURce <Source>

Sets the input channel to which the data line is connected.

Suffix:

| | |
|-----|--------------------------|
| | 1, 2
Selects the bus. |
|-----|--------------------------|

Parameters:

<Source> CH1 | CH2 | D0 D7
 *RST: CH1

BUS:LIN:POLarity <Polarity>

Sets the polarity of the LIN.

Suffix:

| | |
|-----|--------------------------|
| | 1, 2
Selects the bus. |
|-----|--------------------------|

Parameters:

<Polarity> POSitive | NEGative
 *RST: POS

BUS:LIN:STANdard <Standard>

Selects the version of the LIN standard that is used in the DUT. The setting mainly defines the checksum version used during decoding. The most common version is LIN 2.x. For mixed networks, or if the standard is unknown, set the LIN standard to AUTO.

Suffix:

 1, 2
 Selects the bus.

Parameters:

<Standard> V1X | V2X | J2602 | AUTO

V1X
 LIN Standard V1.x

V2X
 LIN Standard V2.x

J2602
 LIN Standard J206 (sets also BitRate to 10.417 KBit/s)

AUTO
 Any standard

*RST: V1X

BUS:LIN:BITRate <BitRate>

Sets the user defined bit rate for the CAN Decoder.

Suffix:

 1, 2
 Selects the bus.

Parameters:

<BitRate> Range: 1.00E+02 to 1.0081E+06
 *RST: 9.6E+03
 Default unit: Bit/s

14.16.8.2 Trigger

| | |
|-------------------------------|-----|
| TRIGger:A:LIN:TYPE..... | 307 |
| TRIGger:A:LIN:ICONdition..... | 307 |
| TRIGger:A:LIN:IDENtifier..... | 307 |
| TRIGger:A:LIN:DCONdition..... | 308 |
| TRIGger:A:LIN:DATA..... | 308 |
| TRIGger:A:LIN:DLENgth..... | 308 |

| | |
|------------------------------|-----|
| TRIGger:A:LIN:CHKSError..... | 308 |
| TRIGger:A:LIN:IPERror..... | 309 |
| TRIGger:A:LIN:SYERror..... | 309 |

TRIGger:A:LIN:TYPE <TriggerType>

Specifies the trigger type for LIN.

Parameters:

| | |
|---------------|---|
| <TriggerType> | SYNC WKFRame ID IDDT ERRCondition |
| | SYNC |
| | Sets the trigger to the synchronisation. |
| | WKFRame |
| | Sets the trigger to the wake up frame. |
| | ID |
| | Sets the trigger to the ID of a frame. |
| | IDDT |
| | Sets the trigger to the ID and data of a frame. |
| | ERRCondition |
| | Sets the trigger to the error condition of a frame. |
| *RST: | SYNC |

TRIGger:A:LIN:ICONdition <IdentifierCondition>

Specifies the condition for the identifier.

Parameters:

| | |
|-----------------------|--|
| <IdentifierCondition> | EQUal NEQual GTHan LTHan |
| | EQUal |
| | Sets the condition for identifier to equal. |
| | NEQual |
| | Sets the condition for identifier to not equal. |
| | GTHan |
| | Sets the condition for identifier to greater than. |
| | LTHan |
| | Sets the condition for identifier to less than. |
| *RST: | EQU |

TRIGger:A:LIN:IDENtifier <Identifier>

Specifies the identifier, only 6 character are allowed.

Parameters:

| | |
|--------------|---|
| <Identifier> | String containing binary pattern. Characters 0, 1, and X are allowed. Enter the 6 bit identifier without parity bits, not the protected identifier. |
|--------------|---|

Example: TRIG:A:LIN:IDEN "100001"

TRIGger:A:LIN:DCondition <DataCondition>

Specifies the condition for the data.

Parameters:

<DataCondition> EQUal | NEQual | GTHan | LTHan

EQUal

Sets the condition for identifier to equal.

NEQual

Sets the condition for identifier to not equal.

GTHan

Sets the condition for identifier to greater than.

LTHan

Sets the condition for identifier to less than.

*RST: EQU

TRIGger:A:LIN:DATA <Data>

Specifies the data for LIN trigger. Depending of [TRIGger:A:LIN:DLEngh](#) setting the number of characters is fixed, all bytes need to be complete.

Parameters:

<Data> String containing binary pattern with max. 64 bit. Characters 0, 1, and X are allowed. Make sure to enter complete bytes.

Example: TRIG:A:LIN:DATA "10100101"

TRIGger:A:LIN:DLEngh <DataLength>

Defines the length of the data pattern - the number of bytes in the pattern.

Parameters:

<DataLength> Range: 1 to 8
 Increment: 1
 *RST: 1
 Default unit: Byte

TRIGger:A:LIN:CHKSError <ChecksumError>

Triggers on a checksum error when trigger type is set to error condition, using [TRIGger:A:LIN:TYPE](#). The checksum verifies the correct data transmission. It is the last byte of the frame response.

Parameters:

<ChecksumError> ON | OFF
 *RST: ON

TRIGger:A:LIN:IPERror <IdParityError>

Triggers on a parity error when trigger type is set to error condition, using [TRIGger:A:LIN:TYPE](#). Parity bits are the bits 6 and 7 of the identifier. They verify the correct transmission of the identifier.

Parameters:

<IdParityError> ON | OFF
 *RST: OFF

TRIGger:A:LIN:SYERror <SyncError>

Specifies the trigger on synchronisation error when trigger type is set to error, using [TRIGger:A:LIN:TYPE](#).

Parameters:

<SyncError> ON | OFF
 *RST: OFF

14.16.8.3 Decode

| | |
|--|-----|
| BUS:LIN:FCOunt? | 309 |
| BUS:LIN:FRAMe<n>:BCOunt? | 310 |
| BUS:LIN:FRAMe<n>:STATus? | 310 |
| BUS:LIN:FRAMe<n>:STARt? | 310 |
| BUS:LIN:FRAMe<n>:STOP? | 311 |
| BUS:LIN:FRAMe<n>:VERSion? | 311 |
| BUS:LIN:FRAMe<n>:DATA? | 311 |
| BUS:LIN:FRAMe<n>:IDStAte? | 312 |
| BUS:LIN:FRAMe<n>:IDVAlue? | 312 |
| BUS:LIN:FRAMe<n>:IDPValue? | 312 |
| BUS:LIN:FRAMe<n>:SYStAte? | 313 |
| BUS:LIN:FRAMe<n>:CSStAte? | 313 |
| BUS:LIN:FRAMe<n>:CSVAlue? | 314 |
| BUS:LIN:FRAMe<n>:BYTE<o>:STATe? | 314 |
| BUS:LIN:FRAMe<n>:BYTE<o>:VALue? | 314 |

BUS:LIN:FCOunt?

Returns the number of received frames of the active LIN bus.

Suffix:

 1, 2
 Selects the bus.

Return values:

<FrameCount> Total number of decoded frames.

Usage: Query only

BUS:LIN:FRAMe<n>:BCOunt?

Returns the number of data bytes in the specified frame.

Suffix:

 1, 2
Selects the bus.

<n> Selects the frame (1...n).

Return values:

<ByteCount> Number of words (bytes)

Usage: Query only

BUS:LIN:FRAMe<n>:STATus?**Suffix:**

 1, 2
Selects the bus.

<n> Selects the frame (1...n).

Return values:

<FrameStatus> OK | CHKS | WAKeup | SYER | INS | ERR | UNDF | IPER

OK

Frame is valid.

CHKS

Checksum error occurred.

WAKeup

Wake up occurred.

SYER

Synchronisation

INS

Identifier is insufficient.

ERR

Error

UNDF

Undefined

IPER

ID parity error

Usage: Query only

BUS:LIN:FRAMe<n>:STARt?

Returns the start time of the specified frame.

Suffix:

 1, 2
Selects the bus.

<n> Selects the frame (1...n).

Return values:

<StartTime> Range: depends on sample rate, and time base
Default unit: s

Usage: Query only

BUS:LIN:FRAME<n>:STOP?

Returns the end time of the specified frame.

Suffix:

 1, 2
Selects the bus.

<n> Selects the frame (1...n).

Return values:

<StopTime> Range: depends on sample rate, and time base
Default unit: s

Usage: Query only

BUS:LIN:FRAME<n>:VERSion?

Returns the version of the LIN standard for the specified frame.

Suffix:

 1, 2
Selects the bus.

<n> Selects the frame (1...n).

Return values:

<FrameVersion> V1X | V2X | J2602 | UNK

V1X

LIN version is 1.x

V2X

LIN version is 2.x

J2602

LIN version is J2602

UNK

LIN version is unknown

Usage: Query only

BUS:LIN:FRAME<n>:DATA?

Returns the data bytes of the specified frame.

Suffix:

 1, 2
Selects the bus.

<n> Selects the frame (1...n).

Return values:

<FrameData> Comma-separated list of decimal values of the data bytes.

Usage: Query only

BUS:LIN:FRAMe<n>:IDState?

Returns the identifier state of the selected frame.

Suffix:

 1, 2
Selects the bus.

<n> Selects the frame (1...n).

Return values:

<IdentifierState> OK | PRERror | UNDF | INSufficient

OK

Identifier state is o.k.

PRERror

Parity error at the identifier.

UNDF

Address is undefined.

INSufficient

Identifier is insufficient.

Usage: Query only

BUS:LIN:FRAMe<n>:IDValue?

Returns the identifier value (address)

Suffix:

 1, 2
Selects the bus.

<n> Selects the frame (1...n).

Return values:

<IdentifierValue> Decimal value

Usage: Query only

BUS:LIN:FRAMe<n>:IDPValue?

Returns the parity value.

Suffix:

 1, 2
Selects the bus.

<n> Selects the frame (1...n).

Return values:

<IdentifierParityValue>Decimal value

Usage: Query only

BUS:LIN:FRAME<n>:SYState?

Returns the state of the sync field for the specified frame.

Suffix:

 1, 2
Selects the bus.

<n> Selects the frame (1...n).

Return values:

<SyncFieldState> OK | ERR | UNDF

OK

Sync field state is o.k.

ERR

Sync error.

UNDF

Sync field state is undefined.

Usage: Query only

BUS:LIN:FRAME<n>:CSState?

Returns the checksum state of the specified frame.

Suffix:

 1, 2
Selects the bus.

<n> Selects the frame (1...n).

Return values:

<ChecksumState> OK | ERR | UNDF

OK

Checksum field state is o.k.

ERR

Checksum error.

UNDF

Checksum state is undefined.

Usage: Query only

BUS:LIN:FRAMe<n>:CSValue?

Returns the checksum value.

Suffix:

 1, 2
Selects the bus.

<n> Selects the frame (1...n).

Return values:

<ChecksumValue> Decimal value

Usage: Query only

BUS:LIN:FRAMe<n>:BYTE<o>:STATe?

Returns the state of the specified data byte.

Suffix:

 1, 2
Selects the bus.

<n> Selects the frame (1...n).

<o> Selects the byte number (1...n).

Return values:

<ByteStatus> OK | INS | UART

OK

Byte status is o.k.

INS

Byte status is insufficient.

UART

Error within the byte.

Usage: Query only

BUS:LIN:FRAMe<n>:BYTE<o>:VALue?

Returns the decimal value of the specified byte.

Suffix:

 1, 2
Selects the bus.

<n> Selects the frame (1...n).

<o> Selects the byte number (1...n).

Return values:

<ByteValue> Decimal value

Usage: Query only

14.17 Data and File Management

This chapter describes commands that store or restore data and measurement results.

14.17.1 Output Control

| | |
|--|-----|
| HCOPy:DATA? | 315 |
| HCOPy:FORMat | 315 |
| HCOPy:SIZE:X? | 316 |
| HCOPy:SIZE:Y? | 316 |
| HCOPy:DEStination | 316 |
| MMEMory:NAME | 316 |
| HCOPy[:IMMediate] | 316 |
| HCOPy:LANGUage | 317 |
| HCOPy:PAGE:SIZE | 317 |
| HCOPy:PAGE:ORientation | 317 |
| HCOPy:COLor:SCHEME | 317 |
| SYSTem:COMMunicate:PRINter:SElect | 317 |
| SYSTem:COMMunicate:PRINter:ENUMerate:FIRSt? | 318 |
| SYSTem:COMMunicate:PRINter:ENUMerate[:NEXT]? | 318 |
| SYSTem:COMMunicate:PRINter:CSET | 318 |

HCOPy:DATA?

Returns the actual display content (screenshot) in binary format.

Return values:

<ScreenData> Block data

Example:

- Stopping the waveform acquisition and send HCOP:DATA?
- Reading the screenshot data bytes until the whole capture is received
- Removing the specific header and saving the data stream

#47609PNG

#4 = 4 letters following

7609 = number of bytes to be transmitted

PNG = PNG file format

In order to get a valid PNG which can be opened by any standard image viewer, the header information must be stripped down and removed until the file starts with „PNG“.

Usage: Query only

HCOPy:FORMat <Format>

Defines the data format of the screenshot.

Parameters:

<Format> BMP | PNG

BMP

Windows Bitmap Format

PNG

Portable Network Graphic

HCOPY:SIZE:X?

Returns the horizontal expansion of the screenshots.

Usage: Query only**HCOPY:SIZE:Y?**

Returns the vertical expansion of the screenshots.

Usage: Query only**HCOPY:DESTination** <Medium>

Defines whether the screenshot is saved or printed.

Parameters:

<Medium> „MMEM“ | „SYST:COMM:PRIN“

String parameter

„MMEM“Saves the screenshot to a file. Specify the file name and location with [MMEMory:NAME](#).**„SYST:COMM:PRIN“**Prints on the printer specified with [SYSTem:COMMunicate:PRINter:SElect](#). The printer must be specified before the [HCOPY:DESTination](#) is sent.

*RST: MMEM

MMEMory:NAME <FileName>Defines the file name to store an image of the display with [HCOPY\[:IMMEDIATE\]](#).**Parameters:**

<FileName> String parameter

HCOPY[:IMMEDIATE]Prints an image of the display to the printer or saves an image to a file or the clipboard, depending on the [HCOPY:DESTination](#) setting.

Before starting the printout, make sure that:

- The printer is defined by [SYSTem:COMMunicate:PRINter:SElect](#).
- The file name for storage is defined by [MMEMory:NAME](#).

Usage: Event

HCOPY:LANGUage <Format>

Defines the format of the printed or saved screenshot.

Parameters:

<Format> GDI | BMP | PNG | GIF

GDI
For output on printer

BMP | PNG | GIF
File formats for saved screenshots.

*RST: PNG

HCOPY:PAGE:SIZE <Size>

Defines the page size to be used.

Parameters:

<Size> A4 | A5 | B5 | B6 | EXECutive

HCOPY:PAGE:ORientation <Orientation>

Defines the page orientation.

Parameters:

<Orientation> LANDscape | PORTrait

HCOPY:COLor:SCHeme <ColorScheme>

Defines the color mode for saved and printed screenshots.

Parameters:

<ColorScheme> COLor | GRAYscale | INVerted

INVerted inverts the colors of the output, i.e. a dark waveform is printed on a white background.

*RST: COLor

SYSTem:COMMunicate:PRINter:SElect <PrinterName>

Selects a configured printer.

Parameters:

<PrinterName> String parameter

Enter the string as it is returned with `SYSTem:COMMunicate:PRINter:ENUMerate:FIRSt?` or `SYSTem:COMMunicate:PRINter:ENUMerate[:NEXT]?`.

SYSTem:COMMunicate:PRINter:ENUMerate:FIRSt?

Queries the name of the first printer in the list of printers. The names of other installed printers can be queried with the `SYSTem:COMMunicate:PRINter:ENUMerate[:NEXT]?` command.

Return values:

<PrinterName> String parameter
If no printer is configured an empty string is returned.

Usage: Query only

SYSTem:COMMunicate:PRINter:ENUMerate[:NEXT]?

Queries the name of the next printer installed. The `SYSTem:COMMunicate:PRINter:ENUMerate:FIRSt?` command should be sent previously to return to the beginning of the printer list and query the name of the first printer.

Return values:

<PrinterName> String parameter
After all available printer names have been returned, an empty string enclosed by quotation marks (") is returned for the next query. Further queries are answered by a query error.

Usage: Query only

SYSTem:COMMunicate:PRINter:CSET <CommandSet>

Sets the printer language that is supported by the printer.

Parameters:

<CommandSet> PCL5 | PCLXI | PS
PCLXI
PCL XL
PS
Postscript

14.17.2 MMEMory Commands

The Mass MEMomory subsystem provides commands to access the storage media and to save and reload instrument settings and data.

The R&S RTC1000 has two storage devices indicated as drives:

- /INT: internal storage with default directories for each data type
- /USB_FRONT: USB connector on the front panel

Common computer and network drives like C:, D:, \\server\share are not available.

Name conventions

The names of files and directories have to meet the following rules:

- Only the 8.3 format with ASCII characters is supported.
- No special characters are allowed.
- Use / (slash) instead of \ (backslash).

| | |
|--------------------------|-----|
| MMEMory:DRIVes? | 319 |
| MMEMory:MSIS | 319 |
| MMEMory:DCATalog? | 319 |
| MMEMory:DCATalog:LENGth? | 320 |
| MMEMory:MDIRectory | 320 |
| MMEMory:CDIRectory | 320 |
| MMEMory:RDIRectory | 321 |
| MMEMory:CATalog? | 321 |
| MMEMory:CATalog:LENGth? | 321 |
| MMEMory:COpy | 322 |
| MMEMory:MOVE | 322 |
| MMEMory:DELete | 322 |
| MMEMory:DATA | 323 |
| MMEMory:STORe:STATe | 323 |
| MMEMory:LOAD:STATe | 323 |

MMEMory:DRIVes?

Returns the storage devices available on the R&S RTC1000.

Return values:

| | |
|---------|--|
| <Drive> | List of strings |
| | /INT:
Internal storage |
| | /USB_FRONT:
USB connector on the front panel |

Usage: Query only

MMEMory:MSIS [<MassStorageIS>]

Changes the storage device (drive).

Parameters:

<MassStorageIS> One of the available drives: /INT or /USB_FRONT

Example:

```
MMEM:MSIS '/USB_FRONT'
```

Sets the USB flash drive connected to the front panel as storage device to be used.

MMEMory:DCATalog? <DirectoryName>

Returns the subdirectories of the specified directory. The result corresponds to the number of strings returned by the `MMEMory:DCATalog:LENGth?` command.

Query parameters:

<DirectoryName> String parameter
Specifies the directory.

Return values:

<FileEntry> String parameter
List of subdirectories separated by commas.

Example:

Query for directories using absolute path:
`MMEM:DCAT? "/USB_FRONT"`
 received "screenshots","data"

Usage: Query only

MMEMory:DCATalog:LENGth? <DirectoryName>

Returns the number of directories in specified directory. The result corresponds to the number of strings returned by the `MMEMory:DCATalog?` command.

Query parameters:

<DirectoryName> String parameter
Specifies the directory.

Return values:

<FileEntryCount> Number of directories.

Usage: Query only

MMEMory:MDIRectory <DirectoryName>

Creates a new directory with the specified name.

Setting parameters:

<DirectoryName> String parameter
Complete path including the storage device.

Example:

Create directory DATA on the front USB flash device, with absolute path:
`MMEM:MDIR "/USB_FRONT/DATA"`

Usage: Setting only

MMEMory:CDIRectory <DirectoryName>

Specifies the current directory for file access.

Setting parameters:

<DirectoryName> String parameter to specify the directory.
If the string also contains the storage device, the command `MMEM:MSIS` is executed implicitly.

Example:

`MMEM:CDIR "/USB_FRONT/DATA"`

MMEMory:RDIRECTory <DirectoryName>

Deletes the specified directory.

Note: All subdirectories and all files in the specified directory and in the subdirectories are deleted!

You cannot delete the current directory or a superior directory. In this case, the instrument returns an execution error.

Setting parameters:

<DirectoryName> String parameter, absolute path or relative to the current directory

Usage: Setting only

MMEMory:CATalog? <DirectoryName>[,<Format>]

Returns the a list of files contained in the specified directory. The result corresponds to the number of files returned by the `MMEMory:CATalog:LENGth?` command.

The list of return values has the following order:

<UsedMemory>, <FreeMemory>, <FileEntry1>, <FileEntry2>, ...

Query parameters:

<DirectoryName> String parameter
Specifies the directory. A filter can be used to list, for example, only files of a given file type.

<Format> ALL | WTIME
ALL: Extended result including file, date, time and attributes
WTIME: Result including file, date, time

Return values:

<UsedMemory> Total amount of storage currently used in the directory, in bytes.

<FreeMemory> Total amount of storage available in the directory, in bytes.

<FileEntry> String parameter
All files of the directory are listed with their file name, format and size in bytes.

Usage: Query only

MMEMory:CATalog:LENGth? <DirectoryName>

Returns the number of files in the specified directory. The result corresponds to the number of files returned by the `MMEMory:CATalog?` command.

Query parameters:

<PathName> String parameter
Directory to be queried, absolute or relative path

Return values:

<Count> Number of files.

Usage: Query only

MMEMory:COPY <FileSource>,<FileDestination>

Copies data to another directory on the same or different storage device. The file name can be changed, too.

Setting parameters:

<FileSource> String parameter

Name and path of the file to be copied

<FileDestination> String parameter

Name and path of the new file. If the file already exists, it is overwritten without notice.

Example: MMEM: COPY "/INT/SETTINGS/SET001.SET",
"/USB_FRONT/SETTINGS/TESTSET1.SET"

Usage: Setting only

MMEMory:MOVE <FileSource>, <FileDestination>

Moves an existing file to a new location.

Setting parameters:

<FileSource> String parameter

Path and name of the file to be moved.

<FileDestination> String parameter

Path and name of the new file.

Example: MMEM: MOVE "/INT/SETTINGS/SET001.SET",
"/USB_FRONT/SETTINGS/SET001.SET"

Usage: Setting only

MMEMory:DELeTe <FileSource>

Deletes a file from the specified directory.

Setting parameters:

<FileSource> String parameter

Name and directory of the file to be deleted.

Usage: Setting only

MMEMory:DATA <FileName>,<Data>

Writes data to the specified file in the current directory (MMEMory:CDIRectory), or reads the data.

Parameters:

<Data> 488.2 block data
The block begins with character '#'. The next digit is the length of the length information. Then the length information digits provide the number of bytes in the binary data.

Parameters for setting and query:

<FileName> String parameter containing the file name

Example: MMEM:DATA "abc.txt", #216This is the file
#2: the length information has two digits
16: the binary data has 16 bytes.
MMEM:DATA? "abc.txt"
received: #216This is the file

MMEMory:STORe:STATe <StateNumber>,<FileName>

Saves the current device settings to the specified file in the current directory.

Setting parameters:

<StateNumber> State 0 (low) or 1 (high)1

<FileName> String parameter
Path and file name

Example: MMEM:CDIR "/USB_FRONT/DATA" '
MMEM:STOR:STAT 1, "MORNING.SET"

Usage: Setting only

MMEMory:LOAD:STATe <StateNumber>,<FileName>

Loads the device settings from the specified file in the current directory.

Setting parameters:

<StateNumber> State 0 (low) or 1 (high)1

<FileName> String parameter
Path and file name

Example: MMEM:CDIR "/USB_FRONT/DATA" '
MMEM:LOAD:STAT 1, "MORNING"

Usage: Setting only

14.18 General Instrument Setup

For printer settings, see [Chapter 14.17.1, "Output Control"](#), on page 315.

| | |
|---|-----|
| CALibration | 324 |
| CALibration:STATe? | 324 |
| DISPlay:LANGuage | 325 |
| SYSTem:NAME | 325 |
| SYSTem:DATE | 325 |
| SYSTem:TIME | 325 |
| SYSTem:TREE? | 326 |
| SYSTem:SET | 326 |
| SYSTem:ERRor[:NEXT]? | 326 |
| SYSTem:ERRor:ALL? | 326 |
| SYST:PRESet | 327 |
| SYSTem:BEEPer[:IMMEDIATE] | 327 |
| SYSTem:BEEPer:TRIG:STATe | 327 |
| SYSTem:BEEPer:CONTRol:STATe | 327 |
| SYSTem:BEEPer:ERRor:STATe | 327 |
| SYSTem:EDUCation:PRESet | 327 |

CALibration

`Calibration` starts the self-alignment process. It can take several minutes. Consider your timeout settings.

`Calibration?` returns information on the state of the self-alignment. Return values $\neq 0$ indicate an error.

Same as `*CAL?`.

Return values:

<SelfAlignment> Numeric status indicator

CALibration:STATe?

Returns the overall state of the self-alignment.

Return values:

<SelfAlignmentState> NOALignment | RUN | ERRor | OK | ABORt

NOALignment

No self-alignment was performed.

RUN

Self-alignment is running.

ERRor

Error occurred.

OK

Self-alignment has been performed successfully.

ABORt

Self-alignment has been cancelled.

Usage: Query only

DISPlay:LANGUage <Language>

Sets the language in which the softkey labels, help and other screen information can be displayed. Supported languages are listed in the „Specifications“ data sheet.

Parameters:

<Language> ENGLISH | GERMan | FRENch | SPANish | RUSSian |
SCHinese | TCHinese
*RST: Reset does not change the language

SYSTem:NAME <Name>

Defines an instrument name.

Parameters:

<Name> String with max. 20 characters

SYSTem:DATE <Year>,<Month>,<Day>

Specifies the internal date for the instrument.

Parameters:

<Year> Increment: 1
Default unit: a

<Month> Range: 1 to 12
Increment: 1

<Day> Range: 1 to 31
Increment: 1
Default unit: d

Usage: SCPI confirmed

SYSTem:TIME <Hour>,<Minute>,<Second>

Specifies the internal time for the instrument.

Parameters:

<Hour> Range: 0 to 23
Increment: 1
Default unit: h

<Minute> Range: 0 to 59
Increment: 1
Default unit: min

<Second> Range: 0 to 59
Increment: 1
Default unit: s

Usage: SCPI confirmed

SYSTem:TREE?

Returns a list of implemented remote commands.

Usage: Query only

SYSTem:SET <Setup>

Defines or queries the device settings that can be saved and load manually with [SAVE/RECALL] > "Device Settings".

Parameters:

<Setup> 488.2 block data

Usage: SCPI confirmed

SYSTem:ERRor[:NEXT]?

Queries the error/event queue for the oldest item and removes it from the queue. The response consists of an error number and a short description of the error. Positive error numbers are instrument-dependent. Negative error numbers are reserved by the SCPI standard..

Return values:

<Error> List of:
 <Error/event_number>,"<Error/event_description>[;<Device-dependent info>]"
 If the queue is empty, the response is 0,"No error"

Usage: Query only
 SCPI confirmed

SYSTem:ERRor:ALL?

Queries the error/event queue for all unread items and removes them from the queue. The response is a comma separated list of error number and a short description of the error in FIFO order. Positive error numbers are instrument-dependent. Negative error numbers are reserved by the SCPI standard.

Return values:

<Error> List of:
 <Error/event_number>,"<Error/event_description>[;<Device-dependent info>]"
 If the queue is empty, the response is 0,"No error"

Usage: Query only
 SCPI confirmed

SYST:PRESet

Resets the instrument to the default state, has the same effect as *RST.

Usage: Event

SYSTem:BEEPer[:IMMEDIATE]

Generates an immediate beep.

Usage: Event

SYSTem:BEEPer:TRIG:STATe <TriggerBeep>

Enables or disables the beep if a trigger occurs.

Parameters:

<TriggerBeep> ON | OFF

SYSTem:BEEPer:CONTRol:STATe <ControlBeep>

Enables or disables a sound for general control events, e.g. reaching the rotary encoder end or changing the measuring mode in the "Automeasure" menu.

Parameters:

<ControlBeep> ON | OFF

SYSTem:BEEPer:ERRor:STATe <ErrorBeep>

Enables or disables the beep if an error occurs.

Parameters:

<ErrorBeep> ON | OFF

SYSTem:EDUCation:PRESet

Deletes the password of the education mode.

Usage: Event

14.19 Status Reporting

14.19.1 STATus:OPERation Register

The commands of the STATus:OPERation subsystem control the status reporting structures of the STATus:OPERation register:

See also:

- [Chapter C.1, "Structure of a SCPI Status Register"](#), on page 346
- [STATus:OPERation Register](#)

The following commands are available:

| | |
|--|-----|
| STATus:OPERation:CONDition? | 328 |
| STATus:OPERation:ENABle | 328 |
| STATus:OPERation:NTRansition | 328 |
| STATus:OPERation:PTRansition | 328 |
| STATus:OPERation[:EVENT]? | 329 |

STATus:OPERation:CONDition?

Returns the of the CONDition part of the operational status register.

Return values:

<Condition> Condition bits in decimal representation. ALIGNment (bit 0) , SELFtest (bit 1) , AUToset (bit 2), WTRigger (bit 3).
 Range: 1 to 65535
 Increment: 1

Usage: Query only

STATus:OPERation:ENABle <Enable>

Controls the ENABle part of the STATus:OPERation register. The ENABle defines which events in the EVENT part of the status register are forwarded to the OPERation summary bit (bit 7) of the status byte. The status byte can be used to create a service request.

Parameters:

<Enable> Range: 1 to 65535
 Increment: 1

Example:

STATus:OPERation:ENABle 5
 The ALIGNment event (bit 0) and AUToset event (bit 2) are forwarded to the OPERation summary bit of the status byte.

STATus:OPERation:NTRansition <NegativeTransition>

Parameters:

<NegativeTransition> Range: 1 to 65535
 Increment: 1

STATus:OPERation:PTRansition <PositiveTransition>

Parameters:

<PositiveTransition> Range: 1 to 65535
 Increment: 1

STATus:OPERation[:EVENT]?

Return values:

<Event> Range: 1 to 65535
 Increment: 1

Usage: Query only

14.19.2 STATus:QUEStionable Registers

The commands of the STATus:QUEStionable subsystem control the status reporting structures of the STATus:QUEStionable registers:

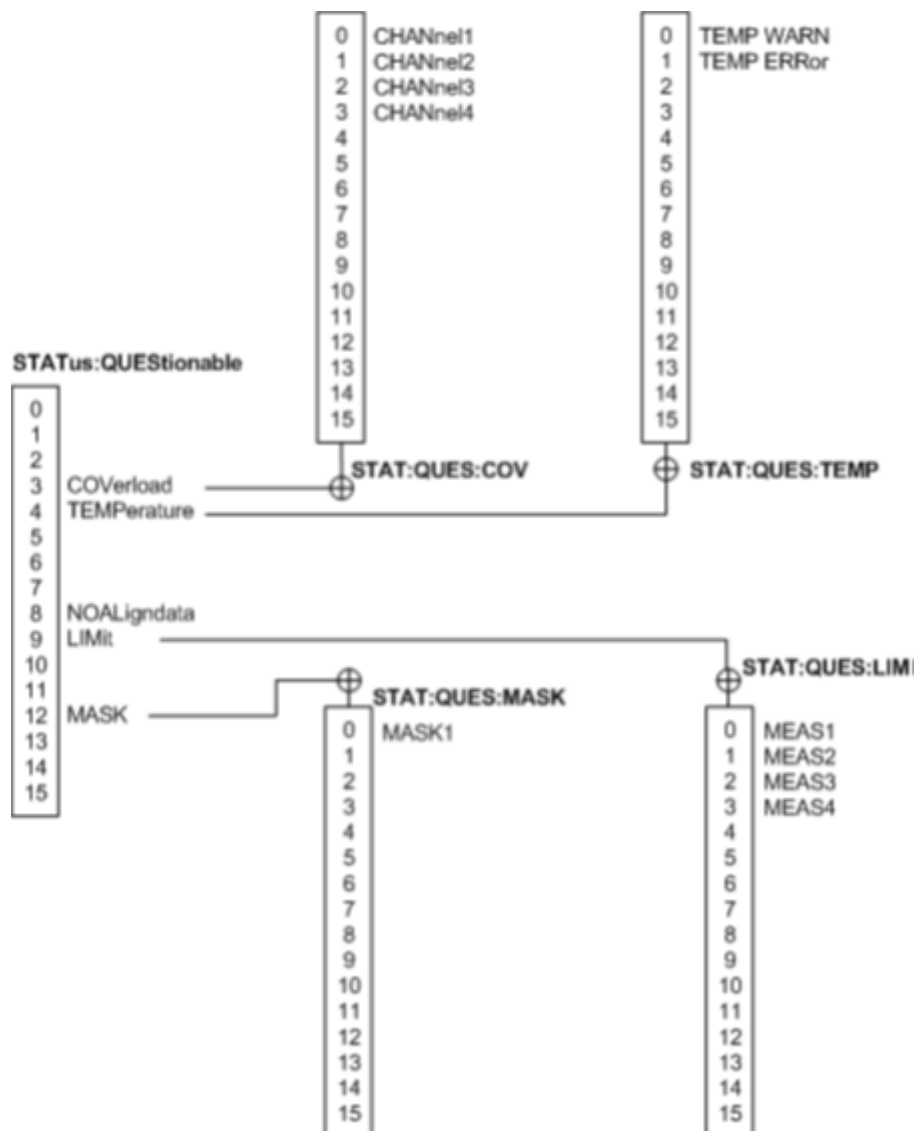

Figure 14-1: Structure of the STATus:QUEStionable register

See also:

- [Chapter C.1, "Structure of a SCPI Status Register"](#), on page 346
- [STATus:QUEStionable Registers](#)

The following commands are available:

| | |
|---|-----|
| STATus:PRESet | 330 |
| STATus:QUEStionable:CONDition? | 330 |
| STATus:QUEStionable:COVerload:CONDition? | 330 |
| STATus:QUEStionable:LIMit:CONDition? | 330 |
| STATus:QUEStionable:MASK:CONDition? | 330 |
| STATus:QUEStionable:ENABLE | 331 |
| STATus:QUEStionable:COVerload:ENABLE | 331 |
| STATus:QUEStionable:LIMit:ENABLE | 331 |
| STATus:QUEStionable:MASK:ENABLE | 331 |
| STATus:QUEStionable[:EVENT]? | 331 |
| STATus:QUEStionable:COVerload[:EVENT]? | 331 |
| STATus:QUEStionable:LIMit[:EVENT]? | 331 |
| STATus:QUEStionable:MASK[:EVENT]? | 331 |
| STATus:QUEStionable:NTRansition | 331 |
| STATus:QUEStionable:COVerload:NTRansition | 331 |
| STATus:QUEStionable:LIMit:NTRansition | 331 |
| STATus:QUEStionable:MASK:NTRansition | 331 |
| STATus:QUEStionable:PTRansition | 332 |
| STATus:QUEStionable:COVerload:PTRansition | 332 |
| STATus:QUEStionable:LIMit:PTRansition | 332 |
| STATus:QUEStionable:MASK:PTRansition | 332 |

STATus:PRESet

Resets all STATUS:QUESTIONABLE registers.

Usage: Event

STATus:QUEStionable:CONDition?

STATus:QUEStionable:COVerload:CONDition?

STATus:QUEStionable:LIMit:CONDition?

STATus:QUEStionable:MASK:CONDition?

Returns the contents of the CONDition part of the status register to check for questionable instrument or measurement states. Reading the CONDition registers does not delete the contents.

Return values:

<Condition> Condition bits in decimal representation
 Range: 0 to 65535
 Increment: 1

Usage: Query only

STATus:QUESTionable:ENABLE <Enable>
STATus:QUESTionable:COVerload:ENABLE <Enable>
STATus:QUESTionable:LIMit:ENABLE <Enable>
STATus:QUESTionable:MASK:ENABLE <Enable>

Sets the ENABLE part that allows true conditions in the EVENT part to be reported in the summary bit. If a bit is set to 1 in the enable part and its associated event bit transitions to true, a positive transition occurs in the summary bit and is reported to the next higher level.

Parameters:

<Enable> Bit mask in decimal representation
 Range: 0 to 65535
 Increment: 1

Example:

STATus:QUESTionable:MASK:ENABLE 24
 Set bits no. 3 and 4 of the STATus:QUESTionable:MASK:ENABLE register part: $24 = 8 + 16 = 2^3 + 2^4$

STATus:QUESTionable[:EVENT]?
STATus:QUESTionable:COVerload[:EVENT]?
STATus:QUESTionable:LIMit[:EVENT]?
STATus:QUESTionable:MASK[:EVENT]?

Returns the contents of the EVENT part of the status register to check whether an event has occurred since the last reading. Reading an EVENT register deletes its contents.

Return values:

<Event> Event bits in decimal representation
 Range: 0 to 65535
 Increment: 1

Usage: Query only

STATus:QUESTionable:NTRansition <NegativeTransition>
STATus:QUESTionable:COVerload:NTRansition <NegativeTransition>
STATus:QUESTionable:LIMit:NTRansition <NegativeTransition>
STATus:QUESTionable:MASK:NTRansition <NegativeTransition>

Sets the negative transition filter. If a bit is set, a 1 to 0 transition in the corresponding bit of the condition register causes a 1 to be written in the corresponding bit of the event register.

Parameters:

<NegativeTransition> Bit mask in decimal representation
 Range: 0 to 65535
 Increment: 1

Example:

STATus:QUESTionable:MASK:NTRansition 24
 Set bits no. 3 and 4 of the STATus:QUESTionable:MASK:NTRansition register part: $24 = 8 + 16 = 2^3 + 2^4$

STATus:QUESTionable:PTRansition <PositiveTransition>

STATus:QUESTionable:COVerload:PTRansition <PositiveTransition>

STATus:QUESTionable:LIMit:PTRansition <PositiveTransition>

STATus:QUESTionable:MASK:PTRansition <PositiveTransition>

Sets the positive transition filter. If a bit is set, a 0 to 1 transition in the corresponding bit of the condition register causes a 1 to be written in the corresponding bit of the event register.

Parameters:

<PositiveTransition> Bit mask in decimal representation

Range: 0 to 65535

Increment: 1

Example:

STATus:QUESTionable:MASK:PTRansition 24

Set bits no. 3 and 4 of the STATus:QUESTionable:MASK:PTRansition register part: $24 = 8 + 16 = 2^3 + 2^4$

15 Contacting Customer Support

Technical support – where and when you need it

For quick, expert help with any Rohde & Schwarz product, contact our customer support center. A team of highly qualified engineers provides support and works with you to find a solution to your query on any aspect of the operation, programming or applications of Rohde & Schwarz products.

Contact information

Contact our customer support center at www.rohde-schwarz.com/support, or follow this QR code:



Figure 15-1: QR code to the Rohde & Schwarz support page

Annex

A SCPI Command Structure

SCPI commands consist of a header and, usually, one or more parameters. The headers may consist of several mnemonics (keywords). Queries are formed by appending a question mark directly to the header.

The commands can be either instrument-specific or instrument-independent (common commands). Common and instrument-specific commands differ in their syntax.

A.1 Syntax for Common Commands

Common (= instrument-independent) commands consist of a header preceded by an asterisk (*), and possibly one or more parameters.

Table A-1: Examples of common commands

| | | |
|-------|----------------------|---|
| *RST | RESET | Resets the instrument. |
| *ESE | EVENT STATUS ENABLE | Sets the bits of the event status enable registers. |
| *ESR? | EVENT STATUS QUERY | Queries the contents of the event status register. |
| *IDN? | IDENTIFICATION QUERY | Queries the instrument identification string. |

A.2 Syntax for Instrument-Specific Commands



Not all commands used in the following examples are necessarily implemented in the instrument. For demonstration purposes only, assume the existence of the following commands for this section:

- `DISPlay[:WINDow<1...4>]:MAXimize <Boolean>`
- `FORMat:READings:DATA <type>[,<length>]`
- `HCOpy:DEvIce:COLor <Boolean>`
- `HCOpy:DEvIce:CMAP:COLor:RGB <red>,<green>,<blue>`
- `HCOpy[:IMMediate]`
- `HCOpy:ITEM:ALL`
- `HCOpy:ITEM:LABel <string>`
- `HCOpy:PAGE:DIMensions:QUADrant[<N>]`
- `HCOpy:PAGE:ORientation LANDscape | PORTrait`
- `HCOpy:PAGE:SCALE <numeric value>`
- `MMEmory:COpy <file_source>,<file_destination>`
- `SENSE:BANDwidth|BWIDth[:RESolution] <numeric_value>`
- `SENSe:FREQuency:STOP <numeric value>`
- `SENSE:LIST:FREQuency <numeric_value>{,<numeric_value>}`

- [Long and Short Form](#)..... 335
- [Numeric Suffixes](#)..... 335
- [Optional Mnemonics](#)..... 336

A.2.1 Long and Short Form

The mnemonics feature a long form and a short form. The short form is marked by upper case letters, the long form corresponds to the complete word. Either the short form or the long form can be entered; other abbreviations are not permitted.

Example:

`HCOpy:DEvIce:COLor ON` is equivalent to `HCOP:DEV:COL ON`.



Case-insensitivity

Upper case and lower case notation only serves to distinguish the two forms in the manual, the instrument itself is case-insensitive.

A.2.2 Numeric Suffixes

If a command can be applied to multiple instances of an object, e.g. specific channels or sources, the required instances can be specified by a suffix added to the command.

Numeric suffixes are indicated by angular brackets (<1...4>, <n>, <i>) and are replaced by a single value in the command. Entries without a suffix are interpreted as having the suffix 1.

Example:

Definition: `HCOPY:PAGE:DIMensions:QUADrant [<N>]`

Command: `HCOP:PAGE:DIM:QUAD2`

This command refers to the quadrant 2.



Different numbering in remote control

For remote control, the suffix may differ from the number of the corresponding selection used in manual operation. SCPI prescribes that suffix counting starts with 1. Suffix 1 is the default state and used when no specific suffix is specified.

Some standards define a fixed numbering, starting with 0. If the numbering differs in manual operation and remote control, it is indicated for the corresponding command.

A.2.3 Optional Mnemonics

Some command systems permit certain mnemonics to be inserted into the header or omitted. These mnemonics are marked by square brackets in the description. The instrument must recognize the long command to comply with the SCPI standard. Some commands are considerably shortened by these optional mnemonics.

Example:

Definition: `HCOPY[:IMMediate]`

Command: `HCOP:IMM` is equivalent to `HCOP`



Optional mnemonics with numeric suffixes

Do not omit an optional mnemonic if it includes a numeric suffix that is relevant for the effect of the command.

Example:

Definition: `DISPlay[:WINDow<1...4>]:MAXimize <Boolean>`

Command: `DISP:MAX ON` refers to window 1.

To refer to a window other than 1, you must include the optional `WINDow` parameter with the suffix for the required window.

`DISP:WIND2:MAX ON` refers to window 2.

A.3 SCPI Parameters

Many commands are supplemented by a parameter or a list of parameters. The parameters must be separated from the header by a "white space" (ASCII code 0 to 9, 11 to 32 decimal, e.g. blank).

The parameters required for each command and the allowed range of values are specified in the command description.

Allowed parameters are:

- [Numeric Values](#)..... 337
- [Special Numeric Values](#)..... 337
- [Boolean Parameters](#)..... 338
- [Text Parameters](#)..... 338
- [Character Strings](#)..... 339
- [Block Data](#)..... 339

A.3.1 Numeric Values

Numeric values can be entered in any form, i.e. with sign, decimal point and exponent. Values exceeding the resolution of the instrument are rounded up or down. The mantissa may comprise up to 255 characters, the exponent must lie inside the value range -32000 to 32000. The exponent is introduced by an "E" or "e". Entry of the exponent alone is not allowed.

Example:

```
SENS:FREQ:STOP 1500000 = SENS:FREQ:STOP 1.5E6
```

Units

For physical quantities, the unit can be entered. If the unit is missing, the basic unit is used. Allowed unit prefixes are:

- G (giga)
- MA (mega), MOHM, MHZ
- K (kilo)
- M (milli)
- U (micro)
- N (nano)

Example:

```
SENSe:FREQ:STOP 1.5GHz = SENSe:FREQ:STOP 1.5E9
```

Some settings allow relative values to be stated in percent. According to SCPI, this unit is represented by the PCT string.

Example:

```
HCOP:PAGE:SCAL 90PCT
```

A.3.2 Special Numeric Values

The following mnemonics are special numeric values. In the response to a query, the numeric value is provided.

- **MIN and MAX:** denote the minimum (MINimum) and maximum (MAXimum) value.
- **DEF:** denotes a preset value (DEFault) which has been stored in the EPROM. This value conforms to the default setting, as it is called by the *RST command.
- **NAN:** Not A Number (NAN) represents the value 9.91E37. NAN is only sent as an instrument response. This value is not defined. Possible causes are the division of zero by zero, the subtraction of infinite from infinite and the representation of missing values.

Example:

Setting command: `SENSe:LIST:FREQ MAXimum`

Query: `SENS:LIST:FREQ?`

Response: `3.5E9`

**Queries for special numeric values**

The numeric values associated to `MAXimum`/`MINimum`/`DEFault` can be queried by adding the corresponding mnemonic after the question mark.

Example: `SENSe:LIST:FREQ? MAXimum`

Returns the maximum numeric value as a result.

A.3.3 Boolean Parameters

Boolean parameters represent two states. The "ON" state (logically true) is represented by "ON" or a numeric value 1. The "OFF" state (logically untrue) is represented by "OFF" or the numeric value 0. The numeric values are provided as the response for a query.

Example:

Setting command: `HCOPY:DEV:COL ON`

Query: `HCOPY:DEV:COL?`

Response: `1`

A.3.4 Text Parameters

Text parameters observe the syntactic rules for mnemonics, i.e. they can be entered using a short or long form. Like any parameter, they have to be separated from the header by a white space. In the response to a query, the short form of the text is provided.

Example:

Setting command: `HCOPY:PAGE:ORIENTATION LANDscape`

Query: `HCOP:PAGE:ORI?`

Response: `LAND`

A.3.5 Character Strings

Always enter strings in quotation marks (' or ").

Example:

```
HCOP:ITEM:LABel "Test1"
```

```
HCOP:ITEM:LABel 'Test1'
```

A.3.6 Block Data

Block data is a format which is suitable for the transmission of large amounts of data. For example, a command using a block data parameter has the following structure:

```
FORMat:READings:DATA #45168xxxxxxxxx
```

The ASCII character # introduces the data block. The next number indicates how many of the following digits describe the length of the data block. In the example, the 4 following digits indicate the length to be 5168 bytes. The data bytes follow. During the transmission of these data bytes all end or other control signs are ignored until all bytes are transmitted.

#0 specifies a data block of indefinite length. The use of the indefinite format requires a NL^END message to terminate the data block. This format is useful when the length of the transmission is not known or if speed or other considerations prevent segmentation of the data into blocks of definite length.

A.4 Overview of Syntax Elements

The following tables provide an overview of the syntax elements and special characters.

Table A-2: Syntax elements

| | |
|-----|---|
| : | The colon separates the mnemonics of a command. |
| ; | The semicolon separates two commands of a command line. It does not alter the path. |
| , | The comma separates several parameters of a command. |
| ? | The question mark forms a query. |
| * | The asterisk marks a common command. |
| ' ' | Quotation marks introduce a string and terminate it (both single and double quotation marks are possible). |
| # | The hash symbol introduces the following numeral systems: <ul style="list-style-type: none"> • Binary: #B10110 • Octal: #O7612 • Hexadecimal: #HF3A7 • Block data: #21312 |
| | A "white space" (ASCII-Code 0 to 9, 11 to 32 decimal, e.g. blank) separates the header from the parameters. |

Table A-3: Special characters

| | |
|-----|--|
| | <p>Parameters</p> <p>A pipe in parameter definitions indicates alternative possibilities in the sense of "or". The effect of the command differs, depending on which parameter is used.</p> <p>Example:</p> <p>Definition:HCOPY:PAGE:ORIENTATION LANDscape PORTRait</p> <p>Command HCOP:PAGE:ORI LAND specifies landscape orientation</p> <p>Command HCOP:PAGE:ORI PORT specifies portrait orientation</p> <p>Mnemonics</p> <p>A selection of mnemonics with an identical effect exists for several commands. These mnemonics are indicated in the same line; they are separated by a pipe. Only one of these mnemonics needs to be included in the header of the command. The effect of the command is independent of which of the mnemonics is used.</p> <p>Example:</p> <p>DefinitionSENSE:BANDwidth BWIDTH[:RESolution] <numeric_value></p> <p>The two following commands with identical meaning can be created:</p> <p>SENS:BAND:RES 1</p> <p>SENS:BWID:RES 1</p> |
| [] | <p>Mnemonics in square brackets are optional and may be inserted into the header or omitted.</p> <p>Example: HCOpy[:IMMEDIATE]</p> <p>HCOP: IMM is equivalent to HCOP</p> |
| { } | <p>Parameters in curly brackets are optional and can be inserted once or several times, or omitted.</p> <p>Example: SENSE:LIST:FREQuency <numeric_value>{,<numeric_value>}</p> <p>The following are valid commands:</p> <p>SENS:LIST:FREQ 10</p> <p>SENS:LIST:FREQ 10,20</p> <p>SENS:LIST:FREQ 10,20,30,40</p> |

A.5 Structure of a Command Line

A command line may consist of one or several commands. It is terminated by one of the following:

- <New Line>
- <New Line> with EOI
- EOI together with the last data byte

Several commands in a command line must be separated by a semicolon ";".

Example:

```
MMEM:COPY "Test1","MeasurementXY";:HCOP:ITEM ALL
```

This command line contains two commands. The first command belongs to the MMEM system, the second command belongs to the HCOP system. If the next command belongs to a different command system, the semicolon is followed by a colon.

Example:

```
HCOP:ITEM ALL;:HCOP:IMM
```

This command line contains two commands. Both commands are part of the HCOP command system, i.e. they have one level in common.

If the successive commands belong to the same system, having one or several levels in common, the command line can be abbreviated. When abbreviating the command line, the second command begins with the level below HCOP. The colon after the semi-colon is omitted. The abbreviated form of the command line reads as follows:

```
HCOP:ITEM ALL;IMM
```

Example:

```
HCOP:ITEM ALL
```

```
HCOP:IMM
```

A new command line always begins with the complete path.

A.6 Responses to Queries

A query is defined for each setting command unless explicitly specified otherwise. It is formed by adding a question mark to the associated setting command. According to SCPI, the responses to queries are partly subject to stricter rules than in standard IEEE 488.2.

- The requested parameter is transmitted without a header.
Example: HCOP:PAGE:ORI?
Response: LAND
- Maximum values, minimum values and all other quantities that are requested via a special text parameter are returned as numeric values.
Example: SENSE:FREQUENCY:STOP? MAX
Response: 3.5E9
- Numeric values are output without a unit. Physical quantities are referred to the basic units or to the units set using the Unit command. The response 3.5E9 in the previous example stands for 3.5 GHz.
- Truth values (Boolean values) are returned as 0 (for OFF) and 1 (for ON).
Example:
Setting command: HCOPI:DEV:COL ON
Query: HCOPI:DEV:COL?
Response: 1
- Text (character data) is returned in a short form.
Example:
Setting command: HCOPI:PAGE:ORIENTATION LANDSCAPE
Query: HCOPI:PAGE:ORI?
Response: LAND
- Invalid numerical results

Sometimes, particularly when a result consists of multiple numeric values, invalid values are returned as 9.91E37 (not a number).

B Command Sequence and Synchronization

IEEE 488.2 defines a distinction between overlapped (asynchronous) and sequential commands:

- A sequential command finishes executing before the next command starts executing. Commands that are processed quickly are usually implemented as sequential commands.
- An overlapping or asynchronous command does not automatically finish executing before the next command starts executing. Usually, overlapping commands take longer to process and allow the program to do other tasks while being executed. If overlapping commands must be executed in a defined order, e.g. to avoid wrong measurement results, they must be serviced sequentially. This method is called synchronization between the controller and the instrument.



As a rule, send commands and queries in different program messages, i.e. in separate command lines.

Do not combine queries with commands that affect the queried value in one program message because the response to the query is not predictable.

The following messages always return correct results:

```
:CHAN:SCAL 0.01;POS 1
```

```
:CHAN:SCAL?
```

```
Result: 0.01 (10 mV/div)
```

Reason: Setting commands within one command line, even though they are implemented as sequential commands, are not necessarily serviced in the order in which they have been received.

For further information, refer to:

- rohde-schwarz.com/rckb: Rohde & Schwarz web page that provides information on instrument drivers and remote control.
- "Automatic Measurement Control - A tutorial on SCPI and IEEE 488.2" from John M. Pieper (R&S order number 0002.3536.00). The book offers detailed information on concepts and definitions of SCPI.

B.1 Preventing Overlapping Execution

To prevent an overlapping execution of commands, one of the commands `*OPC`, `*OPC?` or `*WAI` can be used. All three commands cause a certain action only to be carried out after the hardware has been set. The controller can be forced to wait for the corresponding action to occur.

Table B-1: Synchronization using *OPC, *OPC? and *WAI

| Command | Action | Programming the controller |
|---------|---|---|
| *OPC | Sets the Operation Complete bit in the Standard Event Status Register (ESR) after all previous commands have been executed. | <ul style="list-style-type: none"> Setting bit 0 in the ESE Setting bit 5 in the SRE Waiting for service request (SRQ) |
| *OPC? | Stops command processing until 1 is returned. This occurs when all pending operations are completed. | Send *OPC? directly after the command whose processing must be terminated before other commands can be executed. |
| *WAI | Stops further command processing until all commands sent before Wait-to-Continue Command (WAI) have been executed. | Send *WAI directly after the command whose processing must be terminated before other commands are executed. |

Command synchronization using *WAI or *OPC? is a good choice if the overlapped command takes only little time to process. The two synchronization commands simply block overlapping execution of the command. Append the synchronization command to the overlapped command, for example:

```
SINGLE; *OPC?
```

For time consuming overlapped commands, you can allow the controller or the instrument to do other useful work while waiting for command execution. Use one of the following methods:

***OPC with a service request**

1. Execute *ESE 1

Sets the OPC mask bit (bit No. 0) of the Standard Event Status Register (ESR) to 1

2. Execute *SRE 32

Sets the Event Status Bit (ESB - bit No. 5) of the Service Request Enable Register (SRE) to 1 to enable ESB service request.

3. Send the overlapped command with *OPC

Example: INIT; *OPC

4. Wait for an ESB service request.

The service request indicates that the overlapped command has finished.

***OPC? with a service request**

1. Execute *SRE 16

Sets the Message Available bit (MAV - bit No. 4) of the Service Request Enable Register (SRE) to 1 to enable MAV service request.

2. Send the overlapped command with *OPC?

Example: INIT; *OPC?

3. Wait for an MAV service request.

The service request indicates that the overlapped command has finished.

Event status enable register (ESE)

1. Execute `*ESE 1`

Sets the OPC mask bit (bit No. 0) of the Standard Event Status Register (ESR) to 1

2. Send the overlapped command without `*OPC`, `*OPC?` or `*WAI`.

Example: `INIT; *OPC?`

3. Poll the operation complete state periodically (with a timer) using the sequence:

`*OPC; *ESR?`

A return value (LSB) of 1 indicates that the overlapped command has finished.

C Status Reporting System

The status reporting system stores all information on the current operating state of the instrument, and on errors which have occurred. This information is stored in the status registers and in the error queue. Both can be queried via LAN interface (STATUS... commands).

C.1 Structure of a SCPI Status Register

Each SCPI status register consists of five parts. Each part has a width of 16 bits and has different functions. The individual bits are independent of each other, i.e. each hardware status is assigned a bit number, which is valid for all five parts. Bit 15 (the most significant bit) is set to zero for all parts. Thus, the contents of the register parts can be processed by the controller as positive integers.

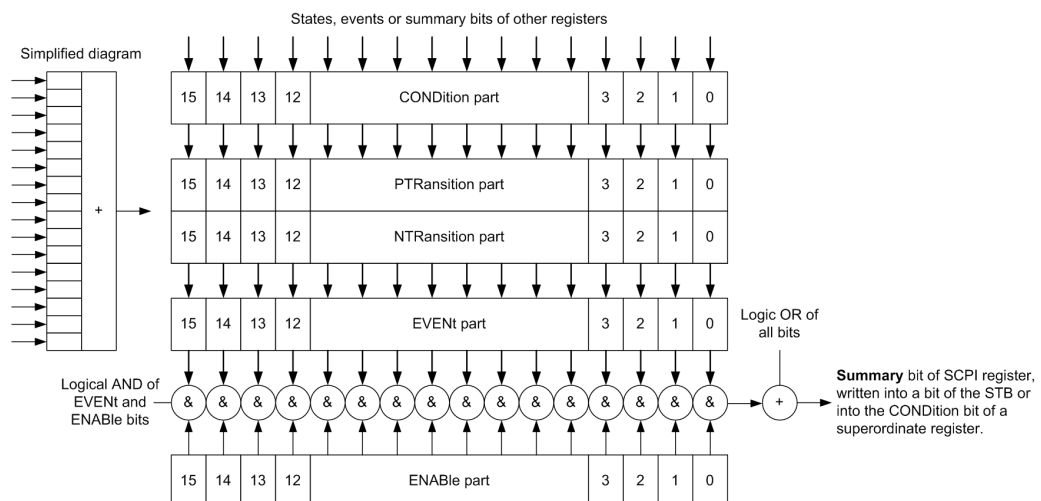

Figure C-1: The status-register model

Description of the five status register parts

The five parts of a SCPI status register have different properties and functions:

- CONDition**
 The **CONDition** part is written directly by the hardware or it mirrors the sum bit of the next lower register. Its contents reflect the current instrument status. This register part can only be read, but not written into or cleared. Its contents are not affected by reading.
- PTRansition / NTRansition**
 The two transition register parts define which state transition of the **CONDition** part (none, 0 to 1, 1 to 0 or both) is stored in the **EVENT** part.
 The **Positive-TRansition** part acts as a transition filter. When a bit of the **CONDition** part is changed from 0 to 1, the associated **PTR** bit decides whether the **EVENT** bit is set to 1.

- PTR bit =1: the `EVENT` bit is set.
- PTR bit =0: the `EVENT` bit is not set.

This part can be written into and read as required. Its contents are not affected by reading.

The **Negative-Transition** part also acts as a transition filter. When a bit of the `CONDition` part is changed from 1 to 0, the associated `NTR` bit decides whether the `EVENT` bit is set to 1.

- NTR bit =1: the `EVENT` bit is set.
- NTR bit =0: the `EVENT` bit is not set.

This part can be written into and read as required. Its contents are not affected by reading.

- **EVENT**

The `EVENT` part indicates whether an event has occurred since the last reading, it is the "memory" of the condition part. It only indicates events passed on by the transition filters. It is permanently updated by the instrument. This part can only be read by the user. Reading the register clears it. This part is often equated with the entire register.

- **ENABLE**

The `ENABLE` part determines whether the associated `EVENT` bit contributes to the sum bit (see below). Each bit of the `EVENT` part is "ANDed" with the associated `ENABLE` bit (symbol '&'). The results of all logical operations of this part are passed on to the sum bit via an "OR" function (symbol '+').

`ENABLE` bit = 0: the associated `EVENT` bit does not contribute to the sum bit

`ENABLE` bit = 1: if the associated `EVENT` bit is "1", the sum bit is set to "1" as well.

This part can be written into and read by the user as required. Its contents are not affected by reading.

Sum bit

The sum bit is obtained from the `EVENT` and `ENABLE` part for each register. The result is then entered into a bit of the `CONDition` part of the higher-order register.

The instrument automatically generates the sum bit for each register. Thus an event can lead to a service request throughout all levels of the hierarchy.

C.2 Hierarchy of status registers

- **STB, SRE**

The `Status Byte (STB)` register and its associated mask register `Service Request Enable (SRE)` form the highest level of the status reporting system. The `STB` provides a rough overview of the instrument status, collecting the information of the lower-level registers.

- **ESR, SCPI registers**

The `STB` receives its information from the following registers:

- The Event Status Register (ESR) with the associated mask register standard Event Status Enable (ESE).
- The STATUS:OPERation and STATUS:QUEStionable registers which are defined by SCPI and contain detailed information on the instrument.
- **Output buffer**
The output buffer contains the messages the instrument returns to the controller. It is not part of the status reporting system but determines the value of the MAV bit in the STB and thus is represented in the overview.

All status registers have the same internal structure.

As shown in the following figure, the status information has a hierarchical structure.

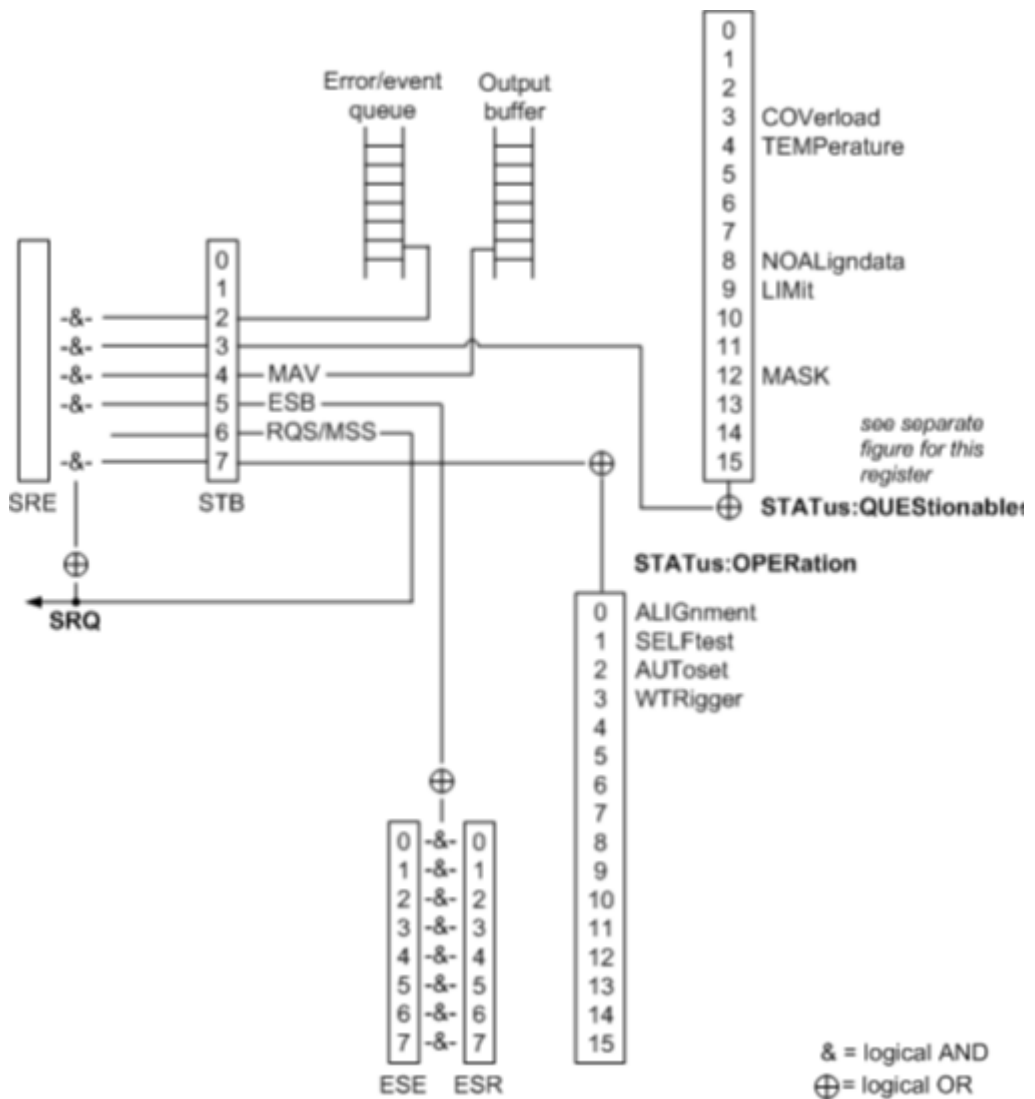

Figure C-2: Overview of the status registers hierarchy

C.3 Contents of the Status Registers

In the following sections, the contents of the status registers are described in more detail.

C.3.1 Status Byte (STB) and Service Request Enable Register (SRE)

The `STatus Byte` (STB) is already defined in IEEE 488.2. It provides a rough overview of the instrument status by collecting the pieces of information of the lower registers. A special feature is that bit 6 acts as the sum bit of the remaining bits of the status byte.

The STB can thus be compared with the `CONDition` part of an SCPI register and assumes the highest level within the SCPI hierarchy.

The STB is read using the command `*STB?` or a serial poll.

The `STatus Byte` (STB) is linked to the `Service Request Enable` (SRE) register. Each bit of the STB is assigned a bit in the SRE. Bit 6 of the SRE is ignored. If a bit is set in the SRE and the associated bit in the STB changes from 0 to 1, a service request (SRQ) is generated. The SRE can be set using the command `*SRE` and read using the command `*SRE?`.

Table C-1: Meaning of the bits used in the status byte

| Bit No. | Meaning |
|---------|--|
| 0...1 | Not used |
| 2 | Error Queue not empty
The bit is set when an entry is made in the error queue. If this bit is enabled by the SRE, each entry of the error queue generates a service request. Thus an error can be recognized and specified in greater detail by polling the error queue. The poll provides an informative error message. This procedure is to be recommended since it considerably reduces the problems involved with remote control. |
| 3 | QUESTionable status register summary bit
The bit is set if an <code>EVENT</code> bit is set in the <code>QUESTionable</code> status register and the associated <code>ENABLE</code> bit is set to 1. A set bit indicates a questionable instrument status, which can be specified in greater detail by querying the <code>STATUS:QUESTionable</code> status register. |
| 4 | MAV bit (message available)
The bit is set if a message is available in the output queue which can be read. This bit can be used to enable data to be automatically read from the instrument to the controller. |
| 5 | ESB bit
Sum bit of the event status register. It is set if one of the bits in the event status register is set and enabled in the event status enable register. Setting of this bit indicates a serious error which can be specified in greater detail by polling the event status register. |

| Bit No. | Meaning |
|---------|--|
| 6 | MSS bit (main status summary bit)
The bit is set if the instrument triggers a service request. This is the case if one of the other bits of this registers is set together with its mask bit in the service request enable register SRE. |
| 7 | STATUS:OPERation status register summary bit
The bit is set if an EVENT bit is set in the OPERATION status register and the associated ENABLE bit is set to 1. A set bit indicates that the instrument is just performing an action. The type of action can be determined by querying the STATUS:OPERation status register. |

C.3.2 Event Status Register (ESR) and Event Status Enable Register (ESE)

The ESR is defined in IEEE 488.2. It can be compared with the EVENT part of a SCPI register. The event status register can be read out using command *ESR?.

The ESE corresponds to the ENABLE part of a SCPI register. If a bit is set in the ESE and the associated bit in the ESR changes from 0 to 1, the ESB bit in the STB is set. The ESE register can be set using the command *ESE and read using the command *ESE?.

Table C-2: Meaning of the bits used in the event status register

| Bit No. | Meaning |
|---------|---|
| 0 | Operation Complete
This bit is set on receipt of the command *OPC exactly when all previous commands have been executed. |
| 1 | Not used |
| 2 | Query Error
This bit is set if either the controller wants to read data from the instrument without having sent a query, or if it does not fetch requested data and sends new instructions to the instrument instead. The cause is often a query which is faulty and hence cannot be executed. |
| 3 | Device-dependent Error
This bit is set if a device-dependent error occurs. An error message with a number between -300 and -399 or a positive error number, which denotes the error in greater detail, is entered into the error queue. |
| 4 | Execution Error
This bit is set if a received command is syntactically correct but cannot be performed for other reasons. An error message with a number between -200 and -300, which denotes the error in greater detail, is entered into the error queue. |
| 5 | Command Error
This bit is set if a command is received, which is undefined or syntactically incorrect. An error message with a number between -100 and -200, which denotes the error in greater detail, is entered into the error queue. |

| Bit No. | Meaning |
|---------|---|
| 6 | User Request
This bit is set when the instrument is switched over to manual control. |
| 7 | Power On (supply voltage on)
This bit is set on switching on the instrument. |

C.3.3 STATUS:OPERation Register

In the `CONDition` part, this register contains information on which actions the instrument is executing. In the `EVENT` part, it contains information on which actions the instrument has executed since the last reading.

It can be read using the commands `STATUS:OPERation:CONDition?` or `STATUS:OPERation[:EVENT]?`, see also [Chapter 14.19.1, "STATUS:OPERation Register"](#), on page 327.

Table C-3: Bits in the STATUS:OPERation register

| Bit No. | Meaning |
|---------|---|
| 0 | <code>ALIGNment</code>
This bit is set as long as the instrument is performing a self-alignment. |
| 1 | <code>SELFtest</code>
This bit is set while a selftest is running. |
| 2 | <code>AUTOset</code>
This bit is set while the instrument is performing an auto setup. |
| 3 | <code>WTRigger</code>
This bit is set while the instrument is waiting for the trigger. |
| 4 to 14 | Not used |
| 15 | This bit is always 0. |

C.3.4 STATUS:QUEStionable Register

This register contains information about indefinite states which may occur if the unit is operated without meeting the specifications. It can be read using the commands `STATUS:QUEStionable:CONDition?` and `STATUS:QUEStionable[:EVENT]?`

The remote commands for the `STATUS:QUEStionable` register are described in [Chapter 14.19.2, "STATUS:QUEStionable Registers"](#), on page 329.

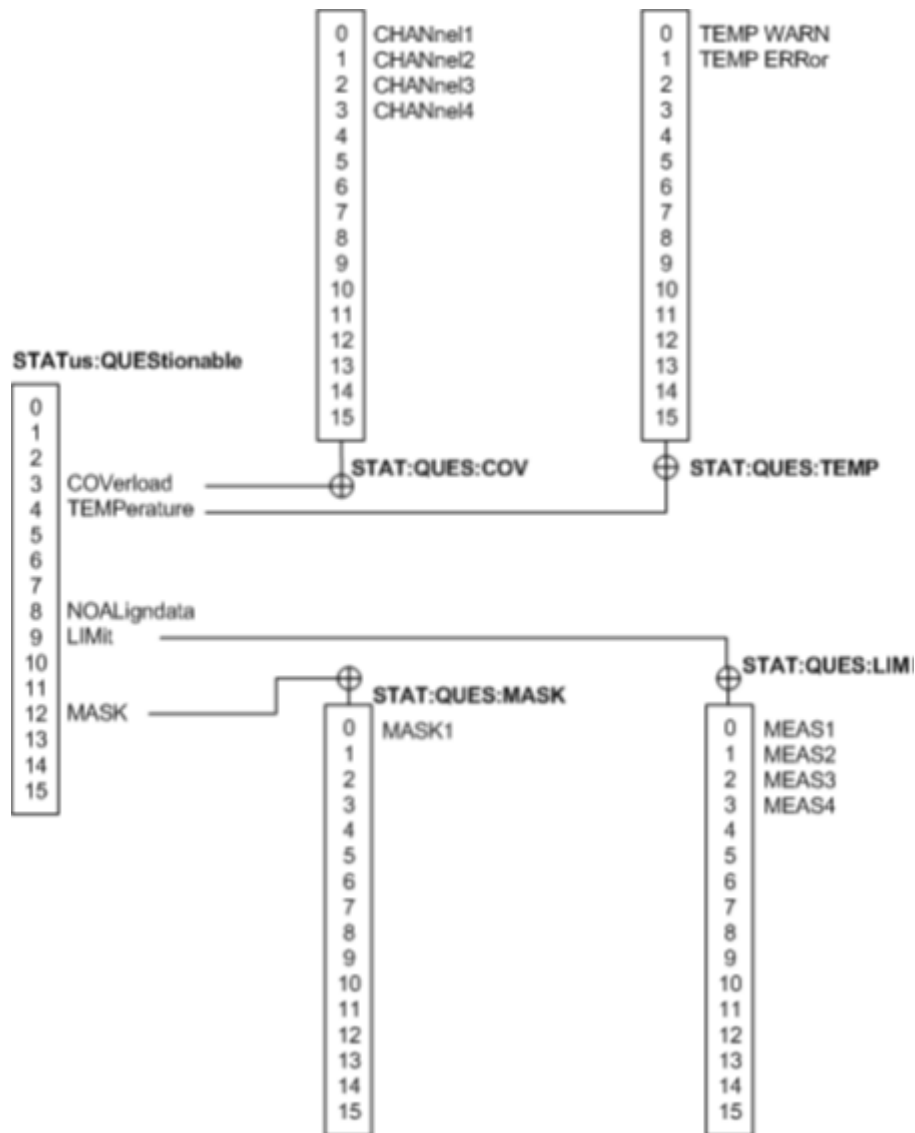

Figure C-3: Overview of the STATUS:QUESTIONABLE register

Table C-4: Bits in the STATUS:QUESTIONABLE register

| Bit No. | Meaning |
|---------|---|
| 0 to 2 | not used |
| 3 | COVerload
This bit is set if a questionable channel overload occurs (see Chapter C.3.4.1, "STATUS:QUESTIONABLE:COVerload register" , on page 353). |
| 4 | TEMPerature
This bit is set if a questionable temperature occurs (see Chapter C.3.4.2, "STATUS:QUESTIONABLE:TEMPerature register" , on page 353). |
| 5 and 7 | Not used |

| Bit No. | Meaning |
|-----------|--|
| 8 | NOALigndata
This bit is set if no alignment data is available - the instrument is uncalibrated. |
| 9 | LIMit
This bit is set if a limit value is violated (see Chapter C.3.4.3, "STATUS:QUESTIONable:LIMit register" , on page 353). |
| 10 and 11 | Not used |
| 12 | MASK
This bit is set if a mask value is violated (see Chapter C.3.4.4, "STATUS:QUESTIONable:MASK register" , on page 354). |
| 13 and 14 | Not used |
| 15 | This bit is always 0. |

C.3.4.1 STATUS:QUESTIONable:COVerload register

This register contains all information about overload of the channels. The bit is set if the assigned channel is overloaded, or if an overload risk occurred (overload warning).

Table C-5: Bits in the STATUS:QUESTIONable:COVerload register

| Bit No. | Meaning |
|---------|----------------------|
| 0 | Overload on CHANne11 |
| 1 | Overload on CHANne12 |

C.3.4.2 STATUS:QUESTIONable:TEMPerature register

This register contains information about the instrument's temperature.

Table C-6: Bits in the STATUS:QUESTIONable:TEMPerature register

| Bit No. | Meaning |
|---------|---|
| 0 | TEMP WARN
This bit is set if a temperature warning on channel 1 or 2 occurred. |
| 1 | TEMP ERROr
This bit is set if a temperature error on channel 1 or 2 occurred. |

C.3.4.3 STATUS:QUESTIONable:LIMit register

These registers contain information about the observance of the limits of measurements. The LIMit bit is set if the limit of the assigned measurement is violated.

Table C-7: Bits in the STATus:QUEStionable:LIMit register

| Bit No. | Meaning |
|---------|---------|
| 0 | MEAS1 |
| 1 | MEAS2 |

C.3.4.4 STATus:QUEStionable:MASK register

This register contains information about the violation of masks. This bit is set if the assigned mask is violated.

Table C-8: Bits in the STATus:QUEStionable:MASK register

| Bit No. | Meaning |
|---------|---------|
| 0 | MASK1 |

C.4 Application of the Status Reporting System

The purpose of the status reporting system is to monitor the status of one or several devices in a measuring system. To do this and react appropriately, the controller must receive and evaluate the information of all devices. The following standard methods are used:

- **Service request** (SRQ) initiated by the instrument
- **Serial poll** of all devices in the bus system, initiated by the controller in order to find out who sent a SRQ and why
- **Parallel poll** of all devices
- Query of a **specific instrument status** by means of commands
- Query of the **error queue**

C.4.1 Service Request

Under certain circumstances, the instrument can send a service request (SRQ) to the controller. Usually this service request initiates an interrupt at the controller, to which the control program can react appropriately. As evident from [Figure C-3](#), an SRQ is always initiated if one or several of bits 2, 3, 4, 5 or 7 of the status byte are set and enabled in the SRE. Each of these bits combines the information of a further register, the error queue or the output buffer. The `ENABLe` parts of the status registers can be set such that arbitrary bits in an arbitrary status register initiate an SRQ. In order to make use of the possibilities of the service request effectively, all bits should be set to "1" in enable registers SRE and ESE.

The SRQ is the only possibility for the instrument to become active on its own. Each controller program should cause the instrument to initiate a service request if errors occur. The program should react appropriately to the service request.

C.4.2 Serial Poll

In a serial poll, just as with command `*STB`, the status byte of an instrument is queried. However, the query is realized via interface messages and is thus clearly faster.

The serial poll method is defined in IEEE 488.1 and used to be the only standard possibility for different instruments to poll the status byte. The method also works for instruments which do not adhere to SCPI or IEEE 488.2.

The serial poll is mainly used to obtain a fast overview of the state of several instruments connected to the controller.

C.4.3 Query of an instrument status

Each part of any status register can be read using queries. There are two types of commands:

- The common commands `*ESR?`, `*IDN?`, `*IST?`, `*STB?` query the higher-level registers.
- The commands of the `STATus` system query the SCPI registers (`STATus:QUEStionable...`)

The returned value is always a decimal number that represents the bit pattern of the queried register. This number is evaluated by the controller program.

Queries are usually used after an SRQ in order to obtain more detailed information on the cause of the SRQ.

C.4.3.1 Decimal representation of a bit pattern

The STB and ESR registers contain 8 bits, the SCPI registers 16 bits. The contents of a status register are specified and transferred as a single decimal number. To make this possible, each bit is assigned a weighted value. The decimal number is calculated as the sum of the weighted values of all bits in the register that are set to 1.

| | | | | | | | | | | | | | | | | | |
|--------|---|---|---|---|----|----|----|-----|-----|---|---|---|---|---|---|---|-----|
| Bits | <table border="1"> <tr> <td>0</td> <td>1</td> <td>2</td> <td>3</td> <td>4</td> <td>5</td> <td>6</td> <td>7</td> <td>...</td> </tr> </table> | | | | | | | | 0 | 1 | 2 | 3 | 4 | 5 | 6 | 7 | ... |
| 0 | 1 | 2 | 3 | 4 | 5 | 6 | 7 | ... | | | | | | | | | |
| Weight | 1 | 2 | 4 | 8 | 16 | 32 | 64 | 128 | ... | | | | | | | | |

Example:

The decimal value $40 = 32 + 8$ indicates that bits no. 3 and 5 in the status register (e.g. the `QUEStionable` status summary bit and the `ESB` bit in the `STatus Byte`) are set.

C.4.4 Error Queue

Each error state in the instrument leads to an entry in the error queue. The entries of the error queue are detailed plain text error messages that can be looked up in the Error Log or queried via remote control using `SYSTem:ERRor[:NEXT]?`. Each call of `SYSTem:ERRor[:NEXT]?` provides one entry from the error queue. If no error messages are stored there any more, the instrument responds with 0, "No error".

The error queue should be queried after every SRQ in the controller program as the entries describe the cause of an error more precisely than the status registers. Especially in the test phase of a controller program the error queue should be queried regularly since faulty commands from the controller to the instrument are recorded there as well.

C.5 Reset Values of the Status Reporting System

The following table contains the different commands and events causing the status reporting system to be reset. None of the commands, except `*RST` and `SYSTem:PRESet`, influence the functional instrument settings. In particular, `DCL` does not change the instrument settings.

Table C-9: Reset of the status reporting system

| Event | Switching on supply voltage
Power-On-Status-Clear | | DCL,
SDC
(Device
Clear,
Selected
Device
Clear) | *RST or
SYS-
Tem:PRE
Set | STA-
Tus:PRE-
Set | *CLS |
|---|--|-----|--|-----------------------------------|-------------------------|------|
| | 0 | 1 | | | | |
| Clear STB, ESR | - | yes | - | - | - | yes |
| Clear SRE, ESE | - | yes | - | - | - | - |
| Clear EVENT parts of the registers | - | yes | - | - | - | yes |
| Clear ENABLE parts of all OPERation and QUEStionable registers;
Fill ENABLE parts of all other registers with "1". | - | yes | - | - | yes | - |
| Fill PTRansition parts with "1";
Clear NTRansition parts | - | yes | - | - | yes | - |
| Clear error queue | yes | yes | - | - | - | yes |
| Clear output buffer | yes | yes | yes | 1) | 1) | 1) |
| Clear command processing and input buffer | yes | yes | yes | - | - | - |

1) The first command in a command line that immediately follows a <PROGRAM MESSAGE TERMINATOR> clears the output buffer.

D General Programming Recommendations

Initial instrument status before changing settings

Manual operation is designed for maximum possible operating convenience. In contrast, the priority of remote control is the "predictability" of the instrument status. Thus, when a command attempts to define incompatible settings, the command is ignored and the instrument status remains unchanged, i.e. other settings are not automatically adapted. Therefore, control programs should always define an initial instrument status (e.g. using the *RST command) and then implement the required settings.

Command sequence

As a general rule, send commands and queries in different program messages. Otherwise, the result of the query may vary depending on which operation is performed first (see also Preventing Overlapping Execution).

Reacting to malfunctions

The service request is the only possibility for the instrument to become active on its own. Each controller program should instruct the instrument to initiate a service request in case of malfunction. The program should react appropriately to the service request.

Error queues

The error queue should be queried after every service request in the controller program as the entries describe the cause of an error more precisely than the status registers. Especially in the test phase of a controller program the error queue should be queried regularly since faulty commands from the controller to the instrument are recorded there as well.

List of commands

| | |
|------------------------------------|-----|
| *CAL? | 169 |
| *CLS | 169 |
| *ESE | 169 |
| *ESR? | 169 |
| *IDN? | 170 |
| *OPC | 170 |
| *OPT? | 170 |
| *PSC | 170 |
| *RST | 171 |
| *SRE | 171 |
| *STB? | 171 |
| *TRG | 171 |
| *TST? | 172 |
| *WAI | 172 |
| ACQUIRE:AVERAge:COMPLete? | 176 |
| ACQUIRE:AVERAge:COUnT | 176 |
| ACQUIRE:FiLTeR:FREQUency | 178 |
| ACQUIRE:HRESolution | 180 |
| ACQUIRE:INTeRpolate | 176 |
| ACQUIRE:MODE | 175 |
| ACQUIRE:PEAKdetect | 180 |
| ACQUIRE:POINts:ARATe? | 179 |
| ACQUIRE:POINts[:VALue]? | 177 |
| ACQUIRE:SRATe? | 179 |
| ACQUIRE:STATe | 179 |
| ACQUIRE:TYPE | 179 |
| ACQUIRE:WRATe | 177 |
| AUToscale | 175 |
| BUS:CAN:BITRate | 294 |
| BUS:CAN:DATA:SOURce | 293 |
| BUS:CAN:FCOunt? | 299 |
| BUS:CAN:FRAMe<n>:ACKState? | 301 |
| BUS:CAN:FRAMe<n>:ACKValue? | 302 |
| BUS:CAN:FRAMe<n>:BCOunt? | 304 |
| BUS:CAN:FRAMe<n>:BSEPosition? | 304 |
| BUS:CAN:FRAMe<n>:BYTe<o>:STATe? | 304 |
| BUS:CAN:FRAMe<n>:BYTe<o>:VALue? | 305 |
| BUS:CAN:FRAMe<n>:CSSTate? | 301 |
| BUS:CAN:FRAMe<n>:CSValue? | 302 |
| BUS:CAN:FRAMe<n>:DATA? | 300 |
| BUS:CAN:FRAMe<n>:DLCState? | 301 |
| BUS:CAN:FRAMe<n>:DLCValue? | 303 |
| BUS:CAN:FRAMe<n>:IDSTate? | 302 |
| BUS:CAN:FRAMe<n>:IDTYpe? | 303 |
| BUS:CAN:FRAMe<n>:IDValue? | 303 |
| BUS:CAN:FRAMe<n>:STARt? | 299 |
| BUS:CAN:FRAMe<n>:STATus? | 299 |

| | |
|---------------------------------------|-----|
| BUS:CAN:FRAMe<n>:STOP? | 300 |
| BUS:CAN:FRAMe<n>:TYPE? | 300 |
| BUS:CAN:SAMPlEpoint | 294 |
| BUS:CAN:TYPE | 294 |
| BUS:CPARAllel:CLOCK:SLOPe | 266 |
| BUS:CPARAllel:CLOCK:SOURce | 266 |
| BUS:CPARAllel:CS:POLarity | 267 |
| BUS:CPARAllel:CS:SOURce | 266 |
| BUS:CPARAllel:DATA<m>:SOURce | 265 |
| BUS:CPARAllel:WIDTh | 267 |
| BUS:DSIGnals | 263 |
| BUS:DSIZe | 263 |
| BUS:FORMat | 263 |
| BUS:I2C:AMODE | 277 |
| BUS:I2C:CLOCK:SOURce | 277 |
| BUS:I2C:DATA:SOURce | 277 |
| BUS:I2C:FCOunt? | 280 |
| BUS:I2C:FRAMe<n>:AACcess? | 282 |
| BUS:I2C:FRAMe<n>:ACCess? | 282 |
| BUS:I2C:FRAMe<n>:ACOMplete? | 284 |
| BUS:I2C:FRAMe<n>:ADBStart? | 284 |
| BUS:I2C:FRAMe<n>:ADDRes? | 283 |
| BUS:I2C:FRAMe<n>:ADEVice? | 283 |
| BUS:I2C:FRAMe<n>:AMODE? | 282 |
| BUS:I2C:FRAMe<n>:ASTart? | 283 |
| BUS:I2C:FRAMe<n>:BCOunt? | 284 |
| BUS:I2C:FRAMe<n>:BYTE<o>:ACCess? | 286 |
| BUS:I2C:FRAMe<n>:BYTE<o>:ACKStart? | 286 |
| BUS:I2C:FRAMe<n>:BYTE<o>:COMplete? | 287 |
| BUS:I2C:FRAMe<n>:BYTE<o>:STARt? | 286 |
| BUS:I2C:FRAMe<n>:BYTE<o>:VALue? | 285 |
| BUS:I2C:FRAMe<n>:DATA? | 285 |
| BUS:I2C:FRAMe<n>:STARt? | 281 |
| BUS:I2C:FRAMe<n>:STATus? | 280 |
| BUS:I2C:FRAMe<n>:STOP? | 281 |
| BUS:LABel | 264 |
| BUS:LABel:STATe | 264 |
| BUS:LIN:BITRate | 306 |
| BUS:LIN:DATA:SOURce | 305 |
| BUS:LIN:FCOunt? | 309 |
| BUS:LIN:FRAMe<n>:BCOunt? | 310 |
| BUS:LIN:FRAMe<n>:BYTE<o>:STATe? | 314 |
| BUS:LIN:FRAMe<n>:BYTE<o>:VALue? | 314 |
| BUS:LIN:FRAMe<n>:CSStAtE? | 313 |
| BUS:LIN:FRAMe<n>:CSVAlue? | 314 |
| BUS:LIN:FRAMe<n>:DATA? | 311 |
| BUS:LIN:FRAMe<n>:IDPVAlue? | 312 |
| BUS:LIN:FRAMe<n>:IDStAtE? | 312 |
| BUS:LIN:FRAMe<n>:IDVAlue? | 312 |
| BUS:LIN:FRAMe<n>:STARt? | 310 |

| | |
|-------------------------------------|-----|
| BUS:LIN:FRAMe<n>:STATus? | 310 |
| BUS:LIN:FRAMe<n>:STOP? | 311 |
| BUS:LIN:FRAMe<n>:SYState? | 313 |
| BUS:LIN:FRAMe<n>:VERSIon? | 311 |
| BUS:LIN:POLarity | 305 |
| BUS:LIN:STANdard | 306 |
| BUS:PARAllel:DATA<m>:SOURce | 265 |
| BUS:PARAllel:WIDTh | 265 |
| BUS:POSition | 264 |
| BUS:SPI:BORDer | 269 |
| BUS:SPI:CLOCK:POLarity | 268 |
| BUS:SPI:CLOCK:SOURce | 268 |
| BUS:SPI:CS:POLarity | 268 |
| BUS:SPI:CS:SOURce | 267 |
| BUS:SPI:DATA:POLarity | 269 |
| BUS:SPI:DATA:SOURce | 269 |
| BUS:SPI:FCOunt? | 271 |
| BUS:SPI:FRAMe<n>:DATA? | 273 |
| BUS:SPI:FRAMe<n>:STARt? | 272 |
| BUS:SPI:FRAMe<n>:STATus? | 272 |
| BUS:SPI:FRAMe<n>:STOP? | 272 |
| BUS:SPI:FRAMe<n>:WCOunt? | 273 |
| BUS:SPI:FRAMe<n>:WORD<o>:MISO? | 274 |
| BUS:SPI:FRAMe<n>:WORD<o>:MOSI? | 274 |
| BUS:SPI:FRAMe<n>:WORD<o>:STARt? | 273 |
| BUS:SPI:FRAMe<n>:WORD<o>:STOP? | 274 |
| BUS:SPI:SSIZe | 269 |
| BUS:SSPI:BITime | 276 |
| BUS:SSPI:BORDer | 276 |
| BUS:SSPI:CLOCK:POLarity | 275 |
| BUS:SSPI:CLOCK:SOURce | 274 |
| BUS:SSPI:DATA:POLarity | 275 |
| BUS:SSPI:DATA:SOURce | 275 |
| BUS:SSPI:SSIZe | 276 |
| BUS:STATe | 262 |
| BUS:TYPE | 263 |
| BUS:UART:BAUDrate | 289 |
| BUS:UART:BITime | 289 |
| BUS:UART:DATA:POLarity | 288 |
| BUS:UART:DATA:SOURce | 287 |
| BUS:UART:FCOunt? | 291 |
| BUS:UART:FRAMe<n>:WCOunt? | 291 |
| BUS:UART:FRAMe<n>:WORD<o>:STARt? | 292 |
| BUS:UART:FRAMe<n>:WORD<o>:STATe? | 292 |
| BUS:UART:FRAMe<n>:WORD<o>:STOP? | 292 |
| BUS:UART:FRAMe<n>:WORD<o>:VALue? | 292 |
| BUS:UART:PARity | 288 |
| BUS:UART:SBIT | 289 |
| BUS:UART:SSIZe | 288 |
| CALCulate:MATH<m>:ARITHmetics | 237 |

| | |
|---|-----|
| CALCulate:MATH<m>:FFT:AVERAge:COUNT..... | 238 |
| CALCulate:MATH<m>:FFT:BANDwidth[:RESolution]:ADJusted?..... | 238 |
| CALCulate:MATH<m>:FFT:BANDwidth[:RESolution]:AUTO..... | 239 |
| CALCulate:MATH<m>:FFT:BANDwidth[:RESolution]:RATio..... | 239 |
| CALCulate:MATH<m>:FFT:BANDwidth[:RESolution][:VALue]..... | 239 |
| CALCulate:MATH<m>:FFT:CFRequency..... | 239 |
| CALCulate:MATH<m>:FFT:FULLspan..... | 239 |
| CALCulate:MATH<m>:FFT:MAGNitude:SCALe..... | 238 |
| CALCulate:MATH<m>:FFT:SPAN..... | 239 |
| CALCulate:MATH<m>:FFT:SRATe?..... | 240 |
| CALCulate:MATH<m>:FFT:START..... | 240 |
| CALCulate:MATH<m>:FFT:STOP..... | 240 |
| CALCulate:MATH<m>:FFT:TIME:POSition..... | 240 |
| CALCulate:MATH<m>:FFT:TIME:RANGe..... | 240 |
| CALCulate:MATH<m>:FFT:WINDow:TYPE..... | 237 |
| CALCulate:QMATH:DATA:HEADer?..... | 229 |
| CALCulate:QMATH:DATA:XINCrement?..... | 230 |
| CALCulate:QMATH:DATA:XORigin?..... | 230 |
| CALCulate:QMATH:DATA:YINCrement?..... | 230 |
| CALCulate:QMATH:DATA:YORigin?..... | 230 |
| CALCulate:QMATH:DATA:YRESolution?..... | 231 |
| CALCulate:QMATH:DATA?..... | 229 |
| CALCulate:QMATH:OPERation..... | 229 |
| CALCulate:QMATH:POSition..... | 229 |
| CALCulate:QMATH:SCALe..... | 229 |
| CALCulate:QMATH:SOURce..... | 228 |
| CALCulate:QMATH:STATe..... | 228 |
| CALibration..... | 324 |
| CALibration:STATe?..... | 324 |
| CHANnel<m>:ARITHmetics..... | 178 |
| CHANnel<m>:BANDwidth..... | 182 |
| CHANnel<m>:COUPling..... | 181 |
| CHANnel<m>:DATA:ENVELOpe:HEADer?..... | 189 |
| CHANnel<m>:DATA:ENVELOpe:XINCrement?..... | 190 |
| CHANnel<m>:DATA:ENVELOpe:XORigin?..... | 190 |
| CHANnel<m>:DATA:ENVELOpe:YINCrement?..... | 190 |
| CHANnel<m>:DATA:ENVELOpe:YORigin?..... | 191 |
| CHANnel<m>:DATA:ENVELOpe:YRESolution?..... | 191 |
| CHANnel<m>:DATA:ENVELOpe?..... | 189 |
| CHANnel<m>:DATA:HEADer?..... | 186 |
| CHANnel<m>:DATA:POINts..... | 187 |
| CHANnel<m>:DATA:XINCrement?..... | 188 |
| CHANnel<m>:DATA:XORigin?..... | 188 |
| CHANnel<m>:DATA:YINCrement?..... | 188 |
| CHANnel<m>:DATA:YORigin?..... | 189 |
| CHANnel<m>:DATA:YRESolution?..... | 189 |
| CHANnel<m>:DATA?..... | 186 |
| CHANnel<m>:LABel..... | 184 |
| CHANnel<m>:LABel:STATe..... | 184 |
| CHANnel<m>:OFFSet..... | 182 |

| | |
|---------------------------------------|-----|
| CHANnel<m>:OVERload..... | 183 |
| CHANnel<m>:POLarity..... | 182 |
| CHANnel<m>:POSition..... | 182 |
| CHANnel<m>:RANGe..... | 181 |
| CHANnel<m>:SCALe..... | 181 |
| CHANnel<m>:SKEW..... | 183 |
| CHANnel<m>:STATe..... | 181 |
| CHANnel<m>:THReshold..... | 183 |
| CHANnel<m>:THReshold:FINDlevel..... | 184 |
| CHANnel<m>:THReshold:HYSteresis..... | 184 |
| CHANnel<m>:TYPE..... | 177 |
| COMPonenttest:FREQuency..... | 258 |
| COMPonenttest:STATe..... | 258 |
| CURSor<m>:AOFF..... | 216 |
| CURSor<m>:FUNCTion..... | 216 |
| CURSor<m>:RESult?..... | 220 |
| CURSor<m>:SNPeak..... | 218 |
| CURSor<m>:SOURce..... | 217 |
| CURSor<m>:SPPeak..... | 218 |
| CURSor<m>:SSCReen..... | 218 |
| CURSor<m>:STATe..... | 216 |
| CURSor<m>:SWAVE..... | 218 |
| CURSor<m>:TRACKing:SCALe[:STATe]..... | 219 |
| CURSor<m>:TRACKing[:STATe]..... | 218 |
| CURSor<m>:X1Position..... | 218 |
| CURSor<m>:X2Position..... | 219 |
| CURSor<m>:X3Position..... | 219 |
| CURSor<m>:XCOupling..... | 220 |
| CURSor<m>:XDELta:INVerse?..... | 220 |
| CURSor<m>:XDELta[:VALue]?..... | 220 |
| CURSor<m>:XRATio:UNIT..... | 221 |
| CURSor<m>:XRATio[:VALue]?..... | 221 |
| CURSor<m>:Y1Position..... | 219 |
| CURSor<m>:Y2Position..... | 219 |
| CURSor<m>:Y3Position..... | 219 |
| CURSor<m>:YCOupling..... | 220 |
| CURSor<m>:YDELta:SLOPe?..... | 220 |
| CURSor<m>:YDELta[:VALue]?..... | 221 |
| CURSor<m>:YRATio:UNIT..... | 222 |
| CURSor<m>:YRATio[:VALue]?..... | 222 |
| DISPlay:DIALog:CLOSE..... | 209 |
| DISPlay:DIALog:MESSage..... | 209 |
| DISPlay:DIALog:TRANSparency..... | 209 |
| DISPlay:GRID:STYLe..... | 213 |
| DISPlay:INTensity:BACKlight..... | 211 |
| DISPlay:INTensity:GRID..... | 211 |
| DISPlay:INTensity:WAVEform..... | 211 |
| DISPlay:LANGuage..... | 209 |
| DISPlay:LANGuage..... | 325 |
| DISPlay:LANGuage:ADD..... | 210 |

| | |
|----------------------------------|-----|
| DISPlay:LANGuage:CATalog? | 210 |
| DISPlay:LANGuage:REMove | 210 |
| DISPlay:MODE | 208 |
| DISPlay:PALette | 208 |
| DISPlay:PERsistence:CLEar | 212 |
| DISPlay:PERsistence:INFinite | 212 |
| DISPlay:PERsistence:STATe | 212 |
| DISPlay:PERsistence:TIME | 212 |
| DISPlay:PERsistence:TIME:AUTO | 212 |
| DISPlay:STYLe | 213 |
| DISPlay:VSCReen:ENABle | 209 |
| DISPlay:VSCReen:POSition | 209 |
| DISPlay:XY:XSource | 210 |
| DISPlay:XY:Y1Source | 211 |
| DVM:ENABle | 255 |
| DVM:POSition | 256 |
| DVM<m>:RESult:RESet | 256 |
| DVM<m>:RESult[:ACTual]:STATus? | 256 |
| DVM<m>:RESult[:ACTual]? | 255 |
| DVM<m>:SOURce | 255 |
| DVM<m>:TYPE | 254 |
| EXPort:WAVEform:NAME | 192 |
| EXPort:WAVEform:SAVE | 192 |
| EXPort:WAVEform:SOURce | 191 |
| EXTern:COUPLing | 259 |
| EXTern:DATA:HEADer? | 261 |
| EXTern:DATA:POINts | 260 |
| EXTern:DATA:XINCrement? | 261 |
| EXTern:DATA:XORigin? | 261 |
| EXTern:DATA:YINCrement? | 261 |
| EXTern:DATA:YORigin? | 262 |
| EXTern:DATA:YRESolution? | 262 |
| EXTern:DATA? | 260 |
| EXTern:POSition | 259 |
| EXTern:SIZE | 259 |
| EXTern:THReshold | 259 |
| EXTern:TYPE | 259 |
| EXTern[:STATe] | 258 |
| FORMat:BORDER | 186 |
| FORMat[:DATA] | 185 |
| GENerator:FREQuency | 247 |
| GENerator:FUNCTion | 247 |
| GENerator:FUNCTion:PULSe:DCYCLE | 248 |
| GENerator:FUNCTion:RAMP:POLarity | 248 |
| GENerator:OUTPut[:ENABle] | 248 |
| GENerator:VOLTagE | 247 |
| GENerator:VOLTagE:OFFSet | 247 |
| HCOPY:COLor:SCHEME | 317 |
| HCOPY:DATA? | 315 |
| HCOPY:DESTination | 316 |

| | |
|--------------------------------------|-----|
| HCOPY:FORMat..... | 315 |
| HCOPY:LANGUage..... | 317 |
| HCOPY:PAGE:ORientation..... | 317 |
| HCOPY:PAGE:SIZE..... | 317 |
| HCOPY:SIZE:X?..... | 316 |
| HCOPY:SIZE:Y?..... | 316 |
| HCOPY[:IMMediate]..... | 316 |
| LOGic< >:LABel..... | 193 |
| LOGic< >:LABel:State..... | 193 |
| LOGic< >:POSition..... | 193 |
| LOGic< >:SIZE..... | 193 |
| LOGic< >:STATe..... | 193 |
| MASK:ACTIon:PRINt:EVENT:MODE..... | 245 |
| MASK:ACTIon:PULSe:EVENT:MODE..... | 245 |
| MASK:ACTIon:SCRSave:DESTination..... | 246 |
| MASK:ACTIon:SCRSave:EVENT:MODE..... | 245 |
| MASK:ACTIon:SOUNd:EVENT:MODE..... | 245 |
| MASK:ACTIon:STOP:EVENT:COUNT..... | 246 |
| MASK:ACTIon:STOP:EVENT:MODE..... | 245 |
| MASK:ACTIon:WFMSave:DESTination..... | 246 |
| MASK:ACTIon:WFMSave:EVENT:MODE..... | 245 |
| MASK:ACTIon:YOUT:ENABLE..... | 245 |
| MASK:CHCopy..... | 242 |
| MASK:COUNt?..... | 243 |
| MASK:DATA:HEADer?..... | 244 |
| MASK:DATA:XINCrement?..... | 244 |
| MASK:DATA:XORigin?..... | 244 |
| MASK:DATA:YINCrement?..... | 244 |
| MASK:DATA:YORigin?..... | 245 |
| MASK:DATA:YRESolution?..... | 245 |
| MASK:DATA?..... | 244 |
| MASK:LOAD..... | 241 |
| MASK:RESet:COUNter..... | 246 |
| MASK:SAVE..... | 242 |
| MASK:SOURce..... | 242 |
| MASK:STATe..... | 241 |
| MASK:TEST..... | 241 |
| MASK:VCOunt?..... | 243 |
| MASK:XWIDth..... | 243 |
| MASK:YPOSition..... | 242 |
| MASK:YSCale..... | 242 |
| MASK:YWIDth..... | 243 |
| MEASurement<m>:AOFF..... | 222 |
| MEASurement<m>:AON..... | 222 |
| MEASurement<m>:ARESt?..... | 222 |
| MEASurement<m>:CATegory?..... | 224 |
| MEASurement<m>:DELay:SLOPe..... | 227 |
| MEASurement<m>:MAIN..... | 224 |
| MEASurement<m>:RESult?..... | 226 |
| MEASurement<m>:SOURce..... | 223 |

| | |
|---|-----|
| MEASurement<m>[:ENABLE]..... | 223 |
| MMEMory:CATalog:LENGth?..... | 321 |
| MMEMory:CATalog?..... | 321 |
| MMEMory:CDIRectory..... | 320 |
| MMEMory:COpy..... | 322 |
| MMEMory:DATA..... | 323 |
| MMEMory:DCATalog:LENGth?..... | 320 |
| MMEMory:DCATalog?..... | 319 |
| MMEMory:DELeTe..... | 322 |
| MMEMory:DRIVes?..... | 319 |
| MMEMory:LOAD:STATe..... | 323 |
| MMEMory:MDIRectory..... | 320 |
| MMEMory:MOVE..... | 322 |
| MMEMory:MSIS..... | 319 |
| MMEMory:NAME..... | 316 |
| MMEMory:RDIRectory..... | 321 |
| MMEMory:STORe:STATe..... | 323 |
| PGENerator:FUNCTion..... | 249 |
| PGENerator:MANual:STATe<s>..... | 254 |
| PGENerator:PATtern:ARBITrary:DATA:APPend..... | 252 |
| PGENerator:PATtern:ARBITrary:DATA:APPend:BAND..... | 252 |
| PGENerator:PATtern:ARBITrary:DATA:APPend:BOR..... | 252 |
| PGENerator:PATtern:ARBITrary:DATA:APPend:INDex..... | 252 |
| PGENerator:PATtern:ARBITrary:DATA:LENGth..... | 252 |
| PGENerator:PATtern:ARBITrary:DATA[:SET]..... | 251 |
| PGENerator:PATtern:BURSt:NCYClE..... | 250 |
| PGENerator:PATtern:BURSt:STATe..... | 250 |
| PGENerator:PATtern:COUNter:DIRectiOn..... | 253 |
| PGENerator:PATtern:COUNter:FREQUency..... | 253 |
| PGENerator:PATtern:FREQUency..... | 250 |
| PGENerator:PATtern:ITIME..... | 250 |
| PGENerator:PATtern:PERiod..... | 250 |
| PGENerator:PATtern:SQUarewave:DCYClE..... | 253 |
| PGENerator:PATtern:SQUarewave:POLarity..... | 253 |
| PGENerator:PATtern:STATe..... | 249 |
| PGENerator:PATtern:STIME..... | 249 |
| PGENerator:PATtern:TRIGger:EXTern:SLOPe..... | 251 |
| PGENerator:PATtern:TRIGger:MODE..... | 251 |
| PGENerator:PATtern:TRIGger:SINGLe..... | 251 |
| POD:CURRent:STATe:MAXimum?..... | 197 |
| POD:CURRent:STATe:MINimum?..... | 197 |
| POD:DATA:HEADer?..... | 195 |
| POD:DATA:POINts..... | 195 |
| POD:DATA:XINCrement?..... | 196 |
| POD:DATA:XORigin?..... | 196 |
| POD:DATA:YINCrement?..... | 196 |
| POD:DATA:YORigin?..... | 196 |
| POD:DATA:YRESolution?..... | 196 |
| POD:DATA?..... | 194 |
| POD:State..... | 194 |

| | |
|--|-----|
| POD:THRshold..... | 194 |
| POD:THRshold:UDLevel<u>..... | 194 |
| PROBe<m>:SETup:ATTenuation:MANual..... | 198 |
| PROBe<m>:SETup:ATTenuation:UNIT..... | 198 |
| PROBe<m>:SETup:ATTenuation[:AUTO]?..... | 198 |
| PROBe<m>:SETup:TYPE?..... | 197 |
| REFCurve<m>:DATA:HEADer?..... | 234 |
| REFCurve<m>:DATA:XINCrement?..... | 235 |
| REFCurve<m>:DATA:XORigin?..... | 235 |
| REFCurve<m>:DATA:YINCrement?..... | 235 |
| REFCurve<m>:DATA:YORigin?..... | 235 |
| REFCurve<m>:DATA:YRESolution?..... | 236 |
| REFCurve<m>:DATA?..... | 234 |
| REFCurve<m>:HORizontal:POSition..... | 233 |
| REFCurve<m>:HORizontal:SCALe..... | 233 |
| REFCurve<m>:LOAD..... | 233 |
| REFCurve<m>:LOAD:STATe..... | 233 |
| REFCurve<m>:SAVE..... | 232 |
| REFCurve<m>:SOURce..... | 231 |
| REFCurve<m>:SOURce:CATalog?..... | 232 |
| REFCurve<m>:STATe..... | 231 |
| REFCurve<m>:UPDate..... | 232 |
| REFCurve<m>:VERTical:POSition..... | 234 |
| REFCurve<m>:VERTical:SCALe..... | 234 |
| REFLevel<m>:RELative:MODE..... | 227 |
| RUN..... | 172 |
| RUNContinuous..... | 173 |
| RUNSingle..... | 173 |
| SINGLE..... | 173 |
| STATus:OPERation:CONDition?..... | 328 |
| STATus:OPERation:ENABLE..... | 328 |
| STATus:OPERation:NTRansition..... | 328 |
| STATus:OPERation:PTRansition..... | 328 |
| STATus:OPERation[:EVENT]?..... | 329 |
| STATus:PRESet..... | 330 |
| STATus:QUEStionable:CONDition?..... | 330 |
| STATus:QUEStionable:COVerload:CONDition?..... | 330 |
| STATus:QUEStionable:COVerload:ENABLE..... | 331 |
| STATus:QUEStionable:COVerload:NTRansition..... | 331 |
| STATus:QUEStionable:COVerload:PTRansition..... | 332 |
| STATus:QUEStionable:COVerload[:EVENT]?..... | 331 |
| STATus:QUEStionable:ENABLE..... | 331 |
| STATus:QUEStionable:LIMit:CONDition?..... | 330 |
| STATus:QUEStionable:LIMit:ENABLE..... | 331 |
| STATus:QUEStionable:LIMit:NTRansition..... | 331 |
| STATus:QUEStionable:LIMit:PTRansition..... | 332 |
| STATus:QUEStionable:LIMit[:EVENT]?..... | 331 |
| STATus:QUEStionable:MASK:CONDition?..... | 330 |
| STATus:QUEStionable:MASK:ENABLE..... | 331 |
| STATus:QUEStionable:MASK:NTRansition..... | 331 |

| | |
|--|-----|
| STATus:QUEStionable:MASK:PTRansition..... | 332 |
| STATus:QUEStionable:MASK[:EVENT]? | 331 |
| STATus:QUEStionable:NTRansition..... | 331 |
| STATus:QUEStionable:PTRansition..... | 332 |
| STATus:QUEStionable[:EVENT]? | 331 |
| STOP..... | 173 |
| SYST:PRESet..... | 327 |
| SYSTem:BEEPer:CONTRol:STATe..... | 327 |
| SYSTem:BEEPer:ERRor:STATe..... | 327 |
| SYSTem:BEEPer:TRIG:STATe..... | 327 |
| SYSTem:BEEPer[:IMMEdiate]..... | 327 |
| SYSTem:COMMunicate:PRINter:CSET..... | 318 |
| SYSTem:COMMunicate:PRINter:ENUMerate:FIRSt? | 318 |
| SYSTem:COMMunicate:PRINter:ENUMerate[:NEXT]? | 318 |
| SYSTem:COMMunicate:PRINter:SElect..... | 317 |
| SYSTem:DATE..... | 325 |
| SYSTem:EDUCation:PRESet..... | 327 |
| SYSTem:ERRor:ALL? | 326 |
| SYSTem:ERRor[:NEXT]? | 326 |
| SYSTem:NAME..... | 325 |
| SYSTem:SET..... | 326 |
| SYSTem:TIME..... | 325 |
| SYSTem:TREE?..... | 326 |
| TCOunter:ENAB..... | 257 |
| TCOunter:RESult[:ACTual]:FREQuency? | 257 |
| TCOunter:RESult[:ACTual]:PERiod? | 257 |
| TI梅base:ACQTime..... | 174 |
| TI梅base:DIVisions? | 174 |
| TI梅base:POSition..... | 174 |
| TI梅base:RANGe..... | 174 |
| TI梅base:RATime? | 174 |
| TI梅base:REFerence..... | 175 |
| TI梅base:ROLL:ENABLE..... | 178 |
| TI梅base:SCALE..... | 173 |
| TI梅base:ZOOM:POSition..... | 214 |
| TI梅base:ZOOM:SCALE..... | 214 |
| TI梅base:ZOOM:STATe..... | 213 |
| TI梅base:ZOOM:TIME..... | 214 |
| TRIGger:A:CAN:ACKerror..... | 297 |
| TRIGger:A:CAN:BITSterror..... | 298 |
| TRIGger:A:CAN:CRCError..... | 298 |
| TRIGger:A:CAN:DATA..... | 297 |
| TRIGger:A:CAN:DCONDition..... | 297 |
| TRIGger:A:CAN:DLEnGth..... | 297 |
| TRIGger:A:CAN:FORMerror..... | 298 |
| TRIGger:A:CAN:FTYPE..... | 295 |
| TRIGger:A:CAN:ICONDition..... | 296 |
| TRIGger:A:CAN:IDENtifier..... | 296 |
| TRIGger:A:CAN:ITYPE..... | 296 |
| TRIGger:A:CAN:TYPE..... | 295 |

| | |
|--------------------------------------|-----|
| TRIGger:A:EDGE:COUPling..... | 202 |
| TRIGger:A:EDGE:FILTer:LPASSs..... | 202 |
| TRIGger:A:EDGE:FILTer:NREJect..... | 202 |
| TRIGger:A:EDGE:SLOPe..... | 201 |
| TRIGger:A:HOLDoff:MODE..... | 200 |
| TRIGger:A:HOLDoff:TIME..... | 200 |
| TRIGger:A:I2C:ACCess..... | 278 |
| TRIGger:A:I2C:ADDResS..... | 279 |
| TRIGger:A:I2C:AMODE..... | 279 |
| TRIGger:A:I2C:MODE..... | 278 |
| TRIGger:A:I2C:PATtern..... | 279 |
| TRIGger:A:I2C:PLENght..... | 279 |
| TRIGger:A:I2C:POFFset..... | 280 |
| TRIGger:A:LEVel<n>[:VALue]..... | 199 |
| TRIGger:A:LIN:CHKSError..... | 308 |
| TRIGger:A:LIN:DATA..... | 308 |
| TRIGger:A:LIN:DCONDition..... | 308 |
| TRIGger:A:LIN:DLENght..... | 308 |
| TRIGger:A:LIN:ICONDition..... | 307 |
| TRIGger:A:LIN:IDENtifier..... | 307 |
| TRIGger:A:LIN:IPERror..... | 309 |
| TRIGger:A:LIN:SYERror..... | 309 |
| TRIGger:A:LIN:TYPE..... | 307 |
| TRIGger:A:MODE..... | 199 |
| TRIGger:A:PATtern:CONDition..... | 206 |
| TRIGger:A:PATtern:FUNCTion..... | 206 |
| TRIGger:A:PATtern:MODE..... | 206 |
| TRIGger:A:PATtern:SOURce..... | 205 |
| TRIGger:A:PATtern:WIDTh:DELTA..... | 207 |
| TRIGger:A:PATtern:WIDTh:RANGe..... | 207 |
| TRIGger:A:PATtern:WIDTh[:WIDTh]..... | 206 |
| TRIGger:A:SOURce..... | 199 |
| TRIGger:A:SPI:MODE..... | 270 |
| TRIGger:A:SPI:PATtern..... | 270 |
| TRIGger:A:SPI:PLENght..... | 271 |
| TRIGger:A:SPI:POFFset..... | 271 |
| TRIGger:A:TV:FIELD..... | 204 |
| TRIGger:A:TV:LINE..... | 205 |
| TRIGger:A:TV:POLarity..... | 204 |
| TRIGger:A:TV:STANdard..... | 204 |
| TRIGger:A:TYPE..... | 200 |
| TRIGger:A:UART:MODE..... | 290 |
| TRIGger:A:UART:PATtern..... | 290 |
| TRIGger:A:UART:PLENght..... | 290 |
| TRIGger:A:UART:POFFset..... | 291 |
| TRIGger:A:WIDTh:DELTA..... | 203 |
| TRIGger:A:WIDTh:POLarity..... | 203 |
| TRIGger:A:WIDTh:RANGe..... | 203 |
| TRIGger:A:WIDTh:WIDTh..... | 203 |
| TRIGger:EXTern:COUPling..... | 201 |

| | |
|---------------------------|-----|
| TRIGger:OUT:MODE..... | 200 |
| TRIGger:OUT:PLENgtH..... | 201 |
| TRIGger:OUT:POLarity..... | 201 |
| TSTamp:AClear..... | 215 |
| TSTamp:CLEar..... | 215 |
| TSTamp:NEXT..... | 214 |
| TSTamp:PREVious..... | 215 |
| TSTamp:SET..... | 214 |