

SPS8 Series Programmable DC Power Supply

User Manual



SPS81X SERIES



SPS85X SERIES







SPS87X SERIES

Saluki Technology Inc.

The document applies to DC power supply of the following models:

- SPS811 programmable DC power supply (150W, 0-5A, 0-30V)
- SPS812 programmable DC power supply (150W, 0-2A, 0-75V)
- SPS813 programmable DC power supply (150W, 0-1A, 0-150V)
- SPS831 programmable DC power supply (30W, 0-1A, 0-30V)
- SPS851 programmable DC power supply (360W, 0-60A, 0-6V)
- SPS852 programmable DC power supply (600W, 0-20A, 0-30V)
- SPS853 programmable DC power supply (600W, 0-8A, 0-75V)
- SPS871 programmable DC power supply (900W, 0-60A, 0-15V)
- SPS872 programmable DC power supply (1050W, 0-35A, 0-30V)
- SPS873 programmable DC power supply (1125W, 0-15A, 0-75V)
- SPS874 programmable DC power supply (1100W, 0-11A, 0-100V)

Options of the SPS8 series DC power supply:

Option No.	Item	Description
M131	RS232 interface communication cable	
M132	RS485 interface communication cable	
M133	USB interface communication cable	
M151	Rack kit (for SPS811)	

Preface

Thank you for choosing Saluki Technology Products.

We devote ourselves to meeting your demands, providing you high-quality measuring instrument and the best after-sales service. We persist with “superior quality and considerate service”, and are committed to offering satisfactory products and service for our clients.

Document No.

SPS8-03-01

Version

Rev01 2022.04

Document Authorization

The information contained in this document is subject to change without notice. The power to interpret the contents of and terms used in this document rests with Saluki.

Saluki Tech owns the copyright of this document which should not be modified or tampered by any organization or individual or reproduced or transmitted for the purpose of making profit without its prior permission, otherwise Saluki will reserve the right to investigate and affix legal liability of infringement.

Product Quality Assurance

The warranty period of the product is 12 months from the date of delivery. The instrument manufacturer will repair or replace damaged parts according to the actual situation within the warranty period.

Product Quality Certificate

The product meets the indicator requirements of the document at the time of delivery. Calibration and measurement are completed by the measuring organization with qualifications specified by the state, and relevant data are provided for reference.

Quality/Settings Management

Research, development, manufacturing and testing of the product comply with the requirements of the quality and environmental management system.

Contacts

Service Tel:	+886. 909 602 109
Website:	www.salukitec.com
Email:	sales@salukitec.com
Address:	No. 367 Fuxing N Road, Taipei 105, Taiwan (R.O.C.)

Content

Chapter 1 Introduction.....	5
Chapter 2 Technical Specifications.....	6
2.1 Main Technical Specification.....	6
2.2 Supplemental Characteristics.....	8
2.3 SPS8 Power Supply Dimension.....	8
Chapter 3 Quick Start.....	12
3.1 Front Panel and Rear Panel.....	12
3.2 Preliminary Checkout.....	13
3.3 If the Power Supply Does Not Turn On.....	13
3.4 How to Adjust the Carrying Handle.....	14
3.5 How to Rackmount the Instrument.....	14
Chapter 4 Panel Operation.....	16
4.1 Key Layout.....	16
4.2 Front-panel Operation Overview.....	17
4.3 Constant Voltage Operation.....	17
4.4 Constant Current Operation.....	18
4.5 Saving and Recalling Operation.....	18
4.6 Menu Operation.....	18
4.6.1 Menu Description.....	18
4.6.2 Menu Function.....	22
4.7 Output On-Off Operation.....	25
4.8 Remote Measurement Function.....	26
4.9 Milliohmmeter Function.....	26
4.10 Voltmeter Function.....	27
Chapter 5 Remote Operation Mode.....	28
5.1 M131/M132/M133 Communication Cable.....	28
5.2 Communication between Power Supply and PC.....	29
Chapter 6 SCPI Communication Protocol.....	31
6.1 SCPI Communication Command Introduction.....	31
6.2 Command Introduction of SPS8 Power Supply.....	32
6.2.1 Basic command (IEEE-488.2 Common Command Set).....	32
6.2.2 System Command.....	32
6.2.3 Measurement Command	33
6.2.4 Setting Command	34
6.2.5 List Operation Related Command.....	37

Chapter 1 Introduction

SPS8 series power supply is high performance single-output programmable DC power supply with communication interface, possessing the character of fast rise time speed (The rise speed of SPS811 power supply can be less than 10mS and the SPS851 can be less than 20ms). The combination of bench-top and system features in SPS8 power supplies provides versatile solutions for your design and test requirements. The SPS8 series can not only be programmed through the keyboard on the panel, but also be functioned as voltmeter and milliohmmeter, which will bring great convenience to the users. As a regeneration product of ordinary programmable power supplies, SPS8 series power supply is more cost-effective.

SPS831 power supply, a new generation of programmable linear power supply, are designed with high speed dynamic programming output (Voltage 0-30V, 1ms rising time), high current accuracy (0.001mA resolution) and low internal resistance, which can satisfy all the test requirements. Meanwhile, the voltage level switch works without relay, which will cause the fast switch between high voltage and low voltage. Moreover, SPS831 power supply provides the best solutions for cellphone research, micro-electronics lab, research institute and special users requiring power supply with low current but high accuracy.

Features

- Low ripple and noise
- High resolution and accuracy (0.1mV/0.01mA, SPS831 reaches up to 0.001mA)
- Built-in a high-accuracy 5 1/2 voltmeter and milliohmmeter
- Supporting high-accuracy and dynamic programming output
- High-luminance VFD screen and two lines & four ways display
- Smart fan will be automatically initiated according to the temperature
- Supporting remote voltage compensation and multidata storage
- Supporting external trigger input and output
- Power-on-self-test, software calibration and standard rack mountable
- Supporting RS232/RS485/USB interface

Chapter 2 Technical Specifications

2.1 Main Technical Specification

(1) SPS81X series power supply technical specification table

Model		SPS811	SPS812	SPS813	SPS831
Output Rating	Voltage	0-30V	0-75V	0-150V	0-30V
	Current	0-5A	0-2A	0-1A	0-1A
Load Regulation	Voltage	<0.01%+0.5mV	<0.01%+0.5mV	<0.01%+0.5mV	<0.01%+0.5mV
	Current	<0.01%+0.1mA	<0.01%+0.1mA	<0.01%+0.1mA	<0.01%+0.1mA
Setting Value Resolution	Voltage	0.5mV	1mV	2mV	0.5mV
	Current	0.1mA	0.05mA	0.01mA	0.01mA
Readback Value Resolution	Voltage	0.1mV	0.1mV	1mV	0.1mV
	Current	0.01mA	0.01mA	0.01mA	0.001mA
Setting Value Accuracy	Voltage	0.01%+2mV	0.01%+5mV	0.01%+10mV	0.01%+2mV
	Current	0.05%+1mA	0.05%+0.5mA	0.05%+0.1mA	0.05%+0.1mA
Readback Value Accuracy	Voltage	0.02%+5mV	0.02%+15mV	0.02%+35mV	0.02%+5mV
	Current	0.1%+5mA	0.05%+2mA	0.05%+1mA	0.02%+1mA
Ripple	Voltage	3mvp-p	5mvp-p	10mvp-p	10mvp-p
	Current	2mA rms	1mA rms	0.5mA rms	0.5mA rms
Voltmeter Accuracy	0-12V Accuracy: 0.02%+2mV 0-58V Accuracy: 0.02%+5mV				
Milliohm-meter Accuracy	10W, 0-1000mΩ Accuracy: 0.2%+3mΩ 1000-10000 mΩ Accuracy: 0.2%+6mΩ				
Working Condition	0-40°C, 0-90%RH				
Power Required	AC 120V/220V±10%, 50/60Hz				
Weight	6.5Kg				
Dimension	214mmW × 101.5mmH × 365mmD				

(2) SPS85X series power supply technical specification table

Model		SPS851	SPS852	SPS853
Output Rating	Voltage	0-6V	0-30V	0-75V
	Current	0-60A	0-20A	0-8A
Load Regulation	Voltage	<0.01%+1mV	<0.01%+1mV	<0.01%+1mV
	Current	<0.01%+0.1mA	<0.01%+0.1mA	<0.01%+0.1mA

Setting Value Resolution	Voltage	0.1mV	0.5mV	1mV
	Current	1mA	0.5mA	0.2mA
Readback Value Resolution	Voltage	0.1mV	0.1mV	0.1mV
	Current	0.1mA	0.1mA	0.1mA
Setting Value Accuracy	Voltage	0.01%+1mV	0.01%+5mV	0.01%+10mV
	Current	0.05%+6mA	0.05%+2mA	0.05%+1mA
Readback Value Accuracy	Voltage	0.02%+2mV	0.02%+5mV	0.02%+15mV
	Current	0.05%+45mA	0.05%+20mA	0.05%+8mA
Ripple	Voltage	3mvp-p	5mvp-p	7mvp-p
	Current	15mA rms	7mA rms	4mA rms
Voltmeter Accuracy	0-12V Accuracy: 0.02%+2mV 0-58V Accuracy: 0.02%+5mV			
Milliohmeter Accuracy	10W, 0-1000mΩ Accuracy: 0.2%+3mΩ 1000-10000 mΩ Accuracy: 0.2%+6mΩ			
Working Condition	0-40°C, 0-90%RH			
Power Required	AC 120V/220V±10%, 50/60Hz			
Weight	28Kg			
Dimension	428mmW × 88mmH × 453.5mmD			

(3) SPS87X series power supply technical specification table

Model		SPS871	SPS872	SPS873	SPS874
Output Rating	Voltage	0-15V	0-30V	0-75V	0-100V
	Current	0-60A	0-35A	0-15A	0-11A
Load Regulation	Voltage	<0.01%+1mV	<0.01%+1mV	<0.01%+1mV	<0.01%+1mV
	Current	<0.01%+0.1mA	<0.01%+0.1mA	<0.01%+0.1mA	<0.01%+0.1mA
Setting Value Resolution	Voltage	0.1mV	0.5mV	2mV	2mV
	Current	1mA	0.5mA	0.2mA	0.2mA
Readback Value Resolution	Voltage	0.1mV	0.1mV	0.1mV	1mV
	Current	0.1mA	0.1mA	0.1mA	0.1mA
Setting Value Accuracy	Voltage	0.01%+1mV	0.01%+5mV	0.01%+10mV	0.01%+15mV
	Current	0.05%+6mA	0.05%+2mA	0.05%+1mA	0.05%+1mA
Readback Value Accuracy	Voltage	0.03%+3mV	0.03%+5mV	0.03%+15mV	0.03%+25mV
	Current	0.05%+45mA	0.05%+25mA	0.05%+12mA	0.05%+10mA
Ripple	Voltage	4mvp-p	5mvp-p	6mvp-p	8mvp-p

	Current	15mA rms	8mA rms	3mA rms	2.5mA rms
Voltmeter Accuracy	0-12V Accuracy: 0.02%+2mV 0-58V Accuracy: 0.02%+5mV				
Milliohmmeter Accuracy	10W: 0-1000mΩ Accuracy: 0.2%+3mΩ 1000-10000 mΩ Accuracy: 0.2%+6mΩ				
Working Condition	0-40°C, 0-90%RH				
Power Required	AC 125V/220V±10%, 50/60Hz				
Weight	45Kg				
Dimension	482mmW × 184.5mmH × 531mmD				

2.2 Supplemental Characteristics

- State storage memory: 50 user-configurable stored states
- Recommended calibration interval: 1 year
- AC input ratings (selectable via switch on the rear panel)
- Option Opt.01: 220VAC ± 10%, 47 to 63 Hz
- Option Opt.02: 110VAC ± 10%, 47 to 63 Hz
- Cooling: forced cooling
- Operating temperature: 0 to 40 °C
- Storage temperature: -20 to 70 °C
- Environmental conditions: designed for indoor use installation category II , pollution degree 2 environment. Designed to operate at maximum relative humidity of 90%

2.3 SPS8 Power Supply Dimension

The dimension of SPS81X/SPS831 series is 214mm W × 101.5mm H × 365mm D.

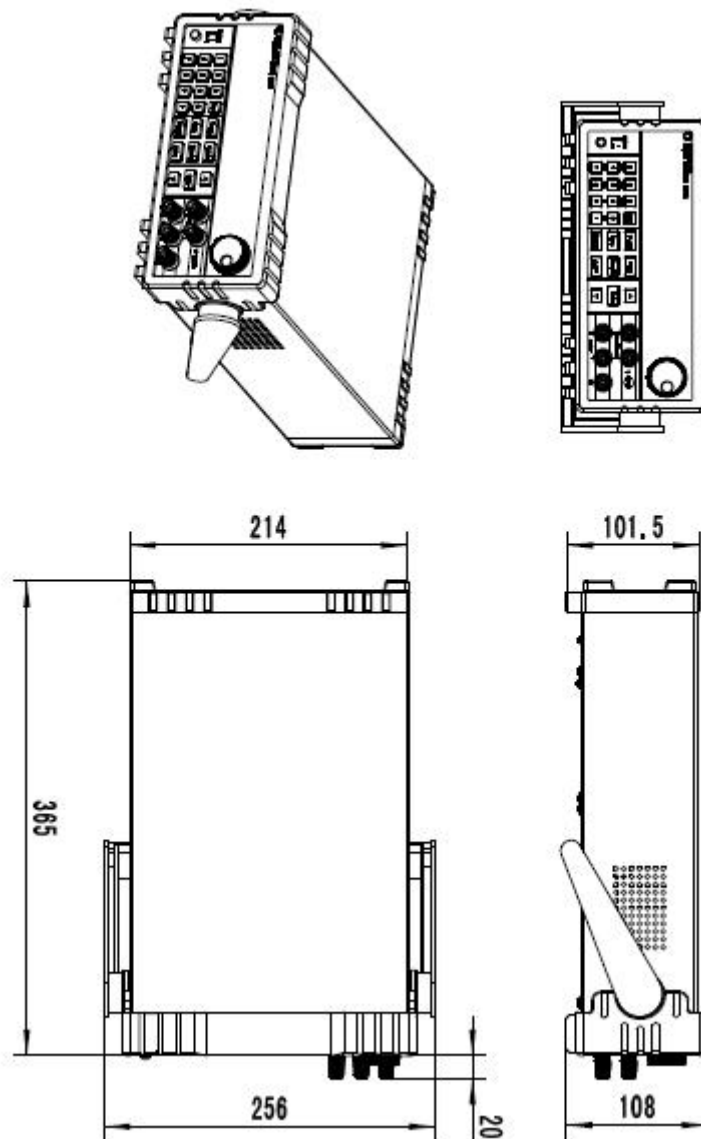

Diagram 2.1 SPS81X/SPS831 Power Supply Dimension

The dimension of SPS85X Series is 428mm W × 88mm H × 453.5mm D.

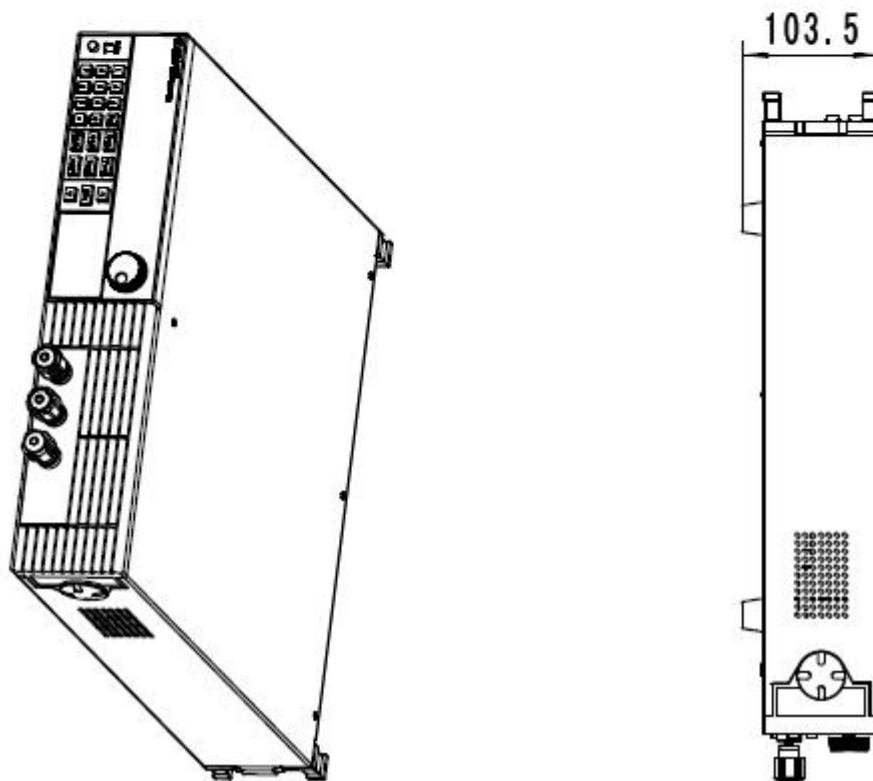
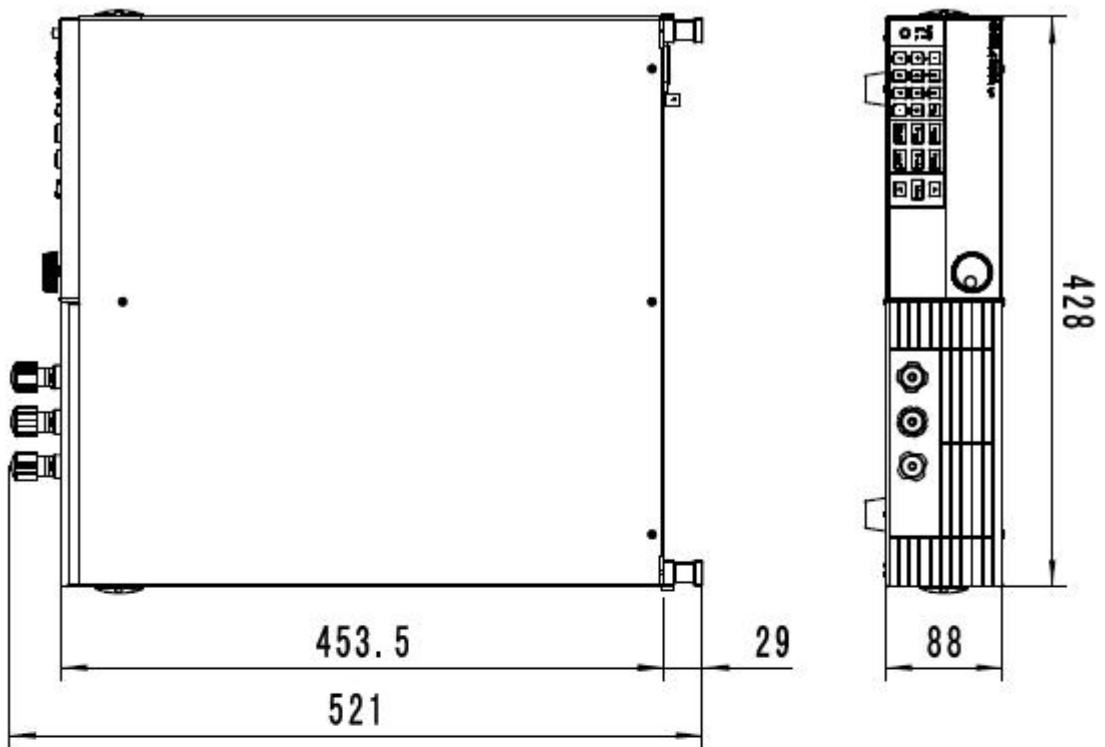

Diagram 2.2 SPS85X Power Supply Dimension

The dimension of SPS87X series is 482mm W × 184.5mm H × 531mm D.

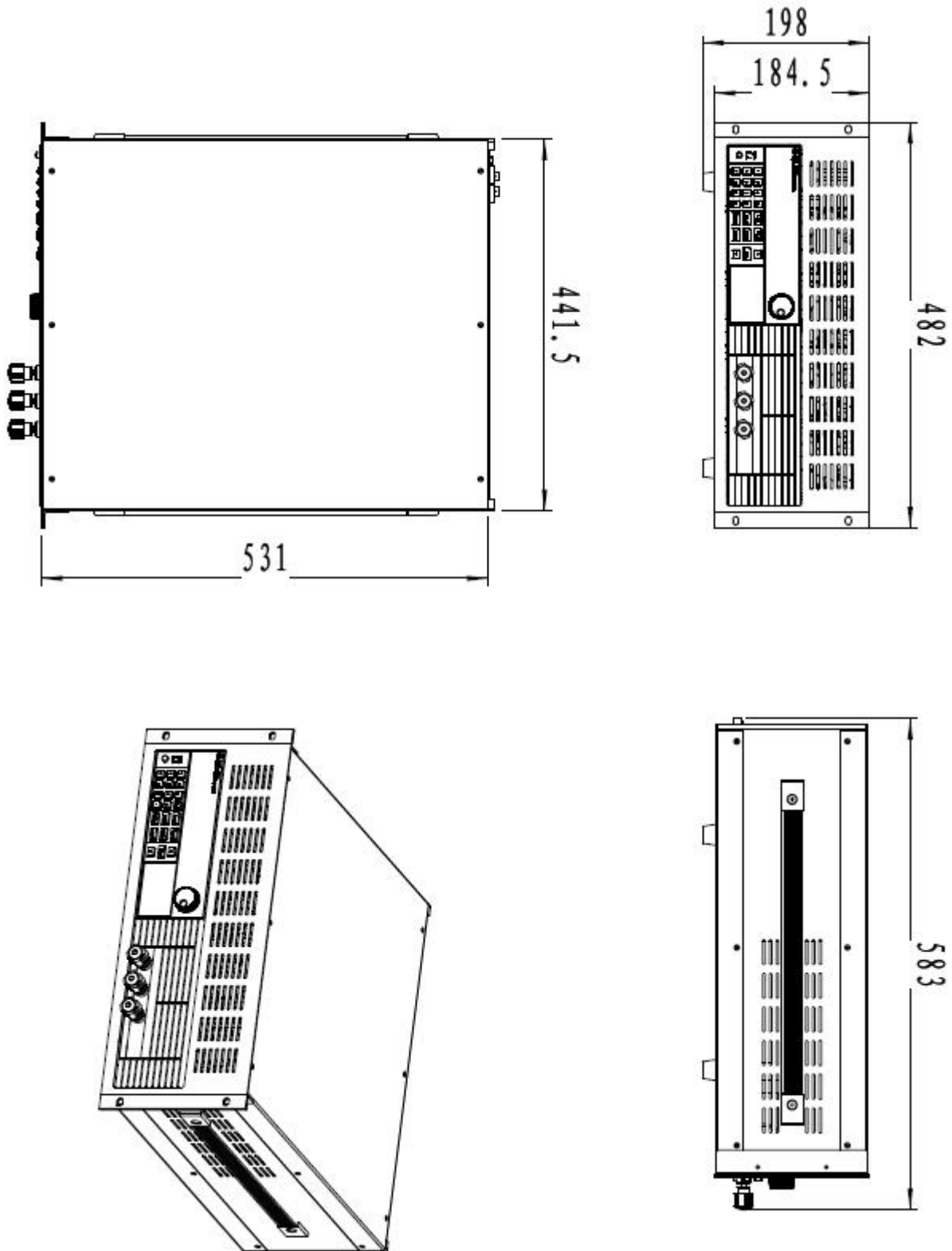

Diagram 2.3 SPS87X Power Supply Dimension

Chapter 3 Quick Start

This chapter mainly focuses on the brief introduction of the surface appearance and basic functions of SPS8 series power supply so that both experienced and inexperienced users can be acquainted with the new products quickly. Meanwhile, the chapter also clarifies some preliminary checkout that should be made prior to operation to make sure the normal running of the products.

3.1 Front Panel and Rear Panel

The front panel layout of SPS81X series power supply is as follows:

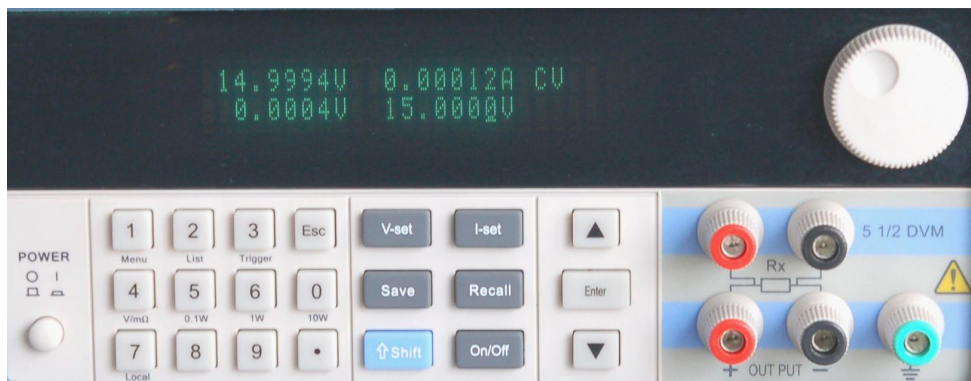

Diagram 3.1 Front Panel of SPS81X Series Power Supply

- The upper half is black VFD display screen and knob
- The bottom half, left side to right side, is numeric keys 0-9, esc key, function keys, up-down keys, enter key, input terminal and output terminal

The rear panel layout of SPS81X is as follows:

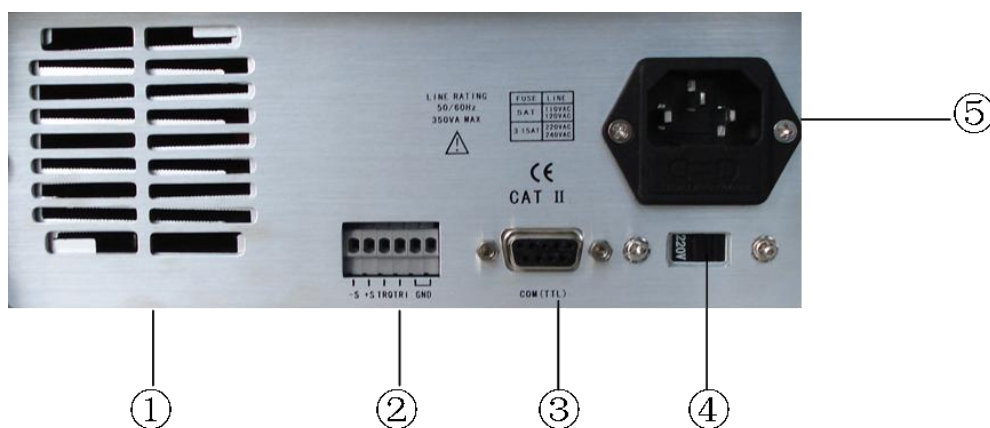

Diagram 3.2 Rear Panel of SPS81X Series Power Supply

- ① cooling window
- ② multifunction connector (remote sensing connector, trigger connector and GND connector)

- ③ 9-pin serial port interface connector
- ④ line voltage selection switch (110 VAC or 220 VAC)
- ⑤ AC input connector

3.2 Preliminary Checkout

The following steps help you verify that the power supply is ready for use.

1. Check the list of supplied items

Verify that you have received the following items with your power supply. If anything is missing, contact your nearest sales office.

- One power cord for your location
- One CD (only when you have bought communication accessories)
- One communication cable (only when you have bought communication accessories)
- One test line (only SPS811 ,SPS812 ,SPS813, SPS831 have the test line)

2. Connect the power cord and turn on the power supply

When you turn on the power supply, the VFD display screen will light up briefly and the power supply performs its power-on self-test. Please check if there is any stroke loss on VFD display.



Warning:Your power supply is equipped with a 3-wire grounding type power cord. The power supply is grounded only when the power-line cord is plugged into an appropriate receptacle. Do not operate your power supply without adequate cabinet ground connection.

3.3 If the Power Supply Does Not Turn On

Use the following steps to help solve problems you might encounter when turning on the instrument.

1. Verify that there is AC power to the power supply.

First, verify that the power cord is firmly plugged into the power receptacle on the rear panel of the power supply. You should also make sure that the power source you plugged the power supply into is energized. Then, verify that the power supply is turned on.

2. Verify the power-line voltage setting.

The line voltage is set to the proper value for your country (110VAC or 220VAC) when the power supply is shipped from the factory. Change the voltage setting if it's not correct.

3. Verify that the correct power-line fuse is installed.

If the fuse was damaged, please see the table below to replace the fuse for your power supply.

Model	Fuse Description (110VAC)	Fuse Description (220VAC)
SPS811	T5A 250V	T3.15A 250V
SPS812	T5A 250V	T3.15A 250V
SPS813	T5A 250V	T3.15A 250V
SPS831	T5A 250V	T3.15A 250V
SPS851	T10A 250V	T6.3A 250V
SPS852	T10A 250V	T6.3A 250V
SPS853	T10A 250V	T6.3A 250V
SPS871	T15A 250V	T10A 250V
SPS872	T15A 250V	T10A 250V
SPS873	T15A 250V	T10A 250V
SPS874	T15A 250V	T10A 250V

4. How to replace the power-line fuse

Open the plastic cover which locates at below the power input socket in the rear panel of the power supply by screwdriver, then you will see the fuse. Please replace the damaged fuse with the matched fuse.

3.4 How to Adjust the Carrying Handle

To adjust the position, grasp the handle by the sides and pull outward. Then, rotate the handle to the desired position. There are following three positions for you to choose:

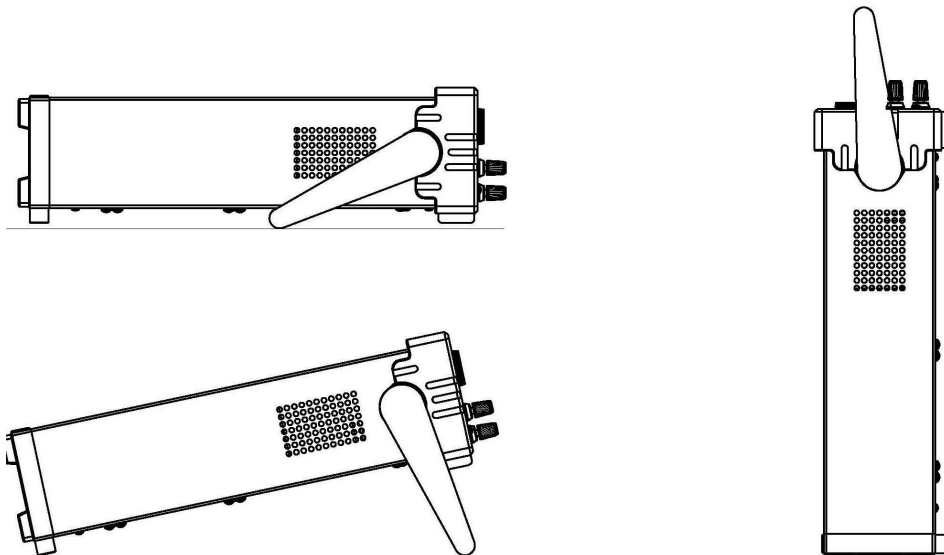

Diagram 3.3 SPS8 series Power Supply Viewing Positions

3.5 How to Rackmount the Instrument

The power supply can be mounted in a standard 19-inch rack cabinet and be easily applied to your testing system. If you want to rackmount the SPS8 series, please buy M151 rack kit.

Note: Remove the carrying handle and the rubber coating on the front panel before rackmounting the instrument.

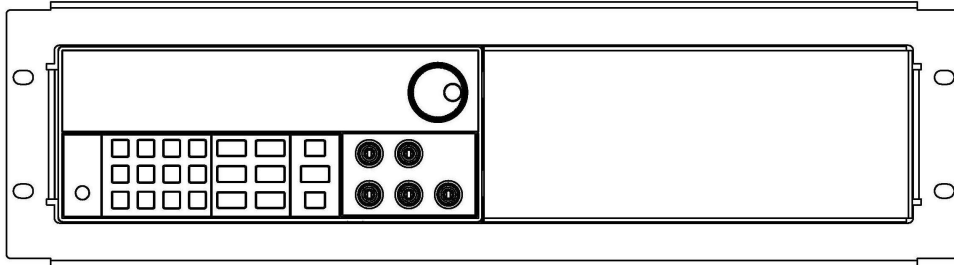

Diagram 3.4 Rackmount a Single Instrument

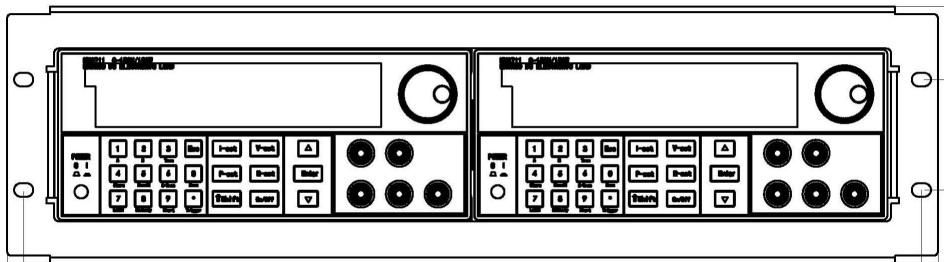

Diagram 3.5 Rackmount two Instruments Side by Side

Chapter 4 Panel Operation

This chapter mainly introduces the front-panel operation in detail from the following parts:

- Key Layout
- The Front Panel Operation Overview
- Voltage Set Operation
- Current Set Operation
- Saving and Recalling Operation
- Menu Operation
- Output ON/OFF Operation
- Remote Measurement Function
- Milliohmmeter Function
- Voltmeter Function

4.1 Key Layout

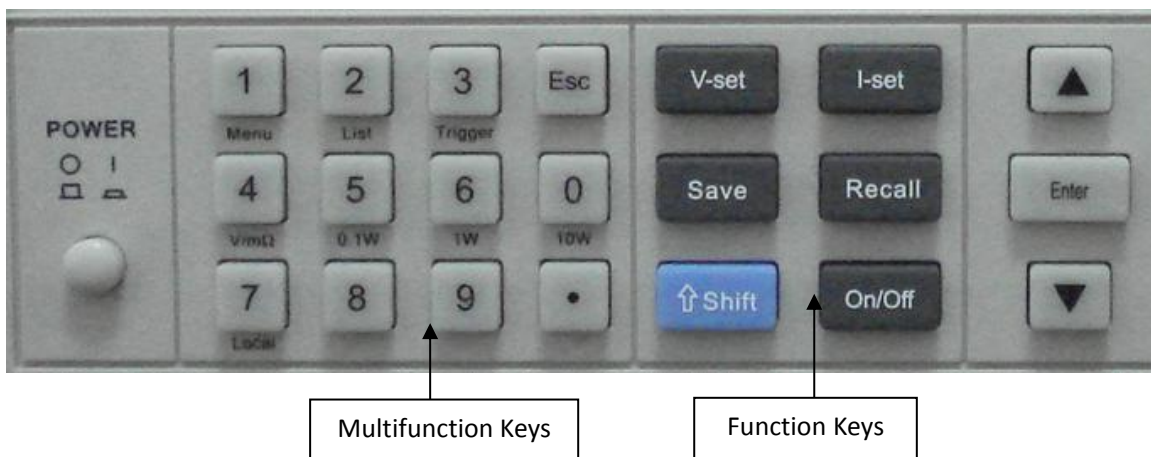



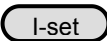

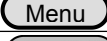
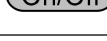
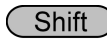



Diagram 4.1 Operation Panel

Multifunction Keys Description

0-9	Numeric keys
Menu	Menu operation key
List	List output operation
Trigger	Trigger key
V/mΩ	Voltmeter and milliohmmeter switch button
0.1W	Choose 0.1W power output operation when the instrument is used as an milliohmmeter
1W	Choose 1W power output when the instrument is used as an milliohmmeter
10W	Choose 10W power output when the instrument is used as an milliohmmeter
Local	Local operation

Esc	Esc key (can be exited from any working condition)
-----	--

Function Keys Description

	Set the voltage value
	Set the current value
	Save the current settings to a specified storage location
	Recall the saved settings from a specified storage location
	Menu operation: set the parameter of the power supply
	Control the output on/off state
	Used together with the multifunction keys to perform diversity functions and applications(for example: <i>shift+Menu</i> can perform menu function)
	Up-key: choose menu item in menu operation or to increase the output voltage
	Down-key: choose menu item in menu operation or to reduce the output voltage
	Enter the selected value or setting

4.2 Front-panel Operation Overview

The following section describes an overview of the front-panel keys before operating your power supply.

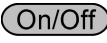
- The power supply is shipped from the factory configured in the front-panel operation mode. At power-on, the power supply is automatically set to operate in the front-panel operation mode. When in this mode, the front panel keys can be used.
- When the power supply is in remote operation mode, you cannot use the front-panel. A change between front-panel and remote operation modes will not result in any change in the output parameters. You can change the front-panel and remote operation modes by PC.
- The output of the power supply can be enabled or disabled from the front panel by pressing the key .
- The VFD display shows the current operating status of the power supply with annunciators. When it is powered on, the VFD will display two lines of data. The first line shows the actual voltage value, actual current value and power supply's status while the second line shows the voltage value that can be measured by voltmeter and output setting value of the power supply.

4.3 Constant Voltage Operation

The constant voltage range is from 0V to the maximum voltage value of each model. It is very easy for you to set the constant voltage output. You have 2 solutions to set the constant voltage value.

Solution 1:

Press the ▲ and ▼ keys to change the value when the SPS8 series power supply is powered on.

Solution 2:

Step1. Power on the SPS8 series instrument

Step2. Press **V-Set** key

Step3. Press the numeric keys **0** to **9** to enter the voltage value you wanted

Step4. Press **Enter** to confirm the value

When you close **Knob Lock** function in **Config** menu, the following two operations also can be used:

- 1) Use upper revolving encoder directly to adjust voltage;
- 2) Press **V-Set** key then use upper revolving encoder to adjust voltage

4.4 Constant Current Operation

The constant current output range is from 0 A to the maximum current value of each type. It is very easy for you to set the constant current output.

Step1. Power on the SPS8 series instrument

Step2. Press **I-Set** key

Step3. Use the numeric keys **0** to **9** to enter the voltage value you wanted

Step4. Press **Enter** key to confirm the value

If you close knob lock function in config menu, please use following operation:

Press **I-Set** key then use upper revolving encoder to adjust voltage

4.5 Saving and Recalling Operation

You can store up to 50 different output states in storage register locations(0~49) so that you can recall the saved settings quickly. This kind of store operation can be performed by the keys **Save** and **Recall** located in the front panel. When the fast recalling is activated, you can press the numeric keys **0** to **9** to invoke the corresponding data.

Each output state includes: 1. Constant voltage value, 2. Constant current value, 3. Maximum voltage setting value, 4. Step voltage value.

After you setting an output state (CV value, CC value and Maximum voltage), press the **Save** key and the numeric keys **0** to **9** to store the output value in a specified memory location.

Press the **Recall** key and the numeric keys **0** to **9** to recall the output value from a specified memory location.

4.6 Menu Operation

4.6.1 Menu Description

Press the key **MENU** to access to the menu function and at the moment the VFD display screen shows the menu items. You can select the menu items by pressing the **▲** and **▼** keys or by rotating the knob, and then press the key **ENTER** to enter in the menu item you wanted. Or you can press the key **Esc** to get back to the higher level menu.

The first level menu includes:

Config: set the function of power supply

System set: set the system parameter

List Set: set list operation

Auto test: set auto test operation

Output Timer: set the duation of output

SN: the serial number of the power supply

Exit: exit the first-level menu

When accessing to **Config** item, the following menu items will be displayed on the VFD display screen by pressing the keys ▲ and ▼.

Init: set all settings to factory default set

Out Memory: set the power supply's output state when it is powered on

On	Setting the same state as last time you turned off the power supply.
Off(Default)	Setting the output to OFF state when the power supply is powered on.

TRI KeepOut: set TRI as preseved output port

On	When TRI is in low voltage level, the output state of power supply is ON. When TRI is in high voltage level, the output state of power supply is OFF. When the TRI KeepOut is enabled, the ON/OFF on the front panel is invalid. The TRI Keepout is only valid to ordinary operation mode. It is invaid to list opeartion and auto test mode.
Off(Default)	Disabled

Fast Recall: set key shortcut function

On	In the main interface (not enter any menu of the power supply), press the key 0~9 to recall the parameters set by Save function
Off(Default)	Disabled

Key Sound: set the key sound

On(Default)	The buzzer will sound when any key was pressed.
Off	The buzzer will not sound when any key was pressed

Knob Lock: set the knob lock state

On	The knob is locked and rotating the knob will not cause any change of the setting value.
Off(Default)	The knob is unlocked and rotating the knob will cause change of the setting value.

Remote Sense: set the remote sense mode

On	Activating the remote sense mode (Rear-panel measurement mode)
Off(Default)	Activating the front-panel measurement mode

Curr Unit: set the unit of current

mA	Set the unit of current is mA
A(Default)	Set the unit of current is A

Match Power: set the matching power

50 HZ(Default)	Match 50HZ
60 HZ	Match 60HZ

Baudrate Set: set the baud rate

4800	Setting the baudrate as 4800bps
9600(Default)	Setting the baudrate as 9600bps
19200	Setting the baudrate as 19200bps
38400	Setting the baudrate as 38400bps

Comm. Parity: set the communication parity

None(Default)	Setting no parity bit
Even	Setting comm. parity as even parity bit
Odd	Setting comm. parity as odd parity bit

Key Lock Set: set the key lock and password function

Password=	When set the password as 0 or pressing the key Enter directly, the Key Lock Set is disable. When the Key Lock Set is enable, the Key Lock Set get locked if no keyboard operation within 60 seconds, the Key Lock Set gets enable only if you input the correct password.
-----------	---

Exit: exit from the current menu

When accessing to **System Set** item, the following menu items will be displayed on the VFD display screen by pressing the keys ▲ and ▼.

Max Volt: set the maximum voltage of the power supply

Max Volt=	Setting the maximum voltage
-----------	-----------------------------

Step Volt: set the step voltage

Step=	After the step voltage set, the voltage value increases or decreases equal to each step voltage by pressing the key ▲ or ▼ once.
-------	--

Exit: exit from the current menu

When accessing to the **List Set** item, the following menu items will be displayed on the VFD display screen by pressing the keys ▲ and ▼.

Load List File: read list file

Edit List File: edit list file

Continuous	Continuous mode, start from the first step to the last step.
Loop Mode	Loop mode, repeatedly execute the steps in accordance with the order of the list.
Step Mode	Step mode, execute single step for one trigger.

Edit File Format: format file in list operation

1X200 Steps	Set list file as 1X200 step
2X100 Steps	Set list file as 2X100 step
4X50 Steps	Set list file as 4X50 step
8X25 Steps	Set list file as 8X25 step

Exit: exit from the current menu

When accessing to the **Auto Test** item, the following menu items will be displayed on the VFD display screen by pressing the keys ▲ and ▼.

Load Atest File: read auto test file

Edit Atest File: edit auto test file

Exit: exit the auto test menu

When accessing to the **Output Timer** item, you can see the item **Close Delay**, which means to set the output timing.

Close Delay: set the duration of the output

The unit of the **Close Delay** is second, the accuracy is 0.001 second; The output switch to OFF state when the duration is over.

The function is disable when the duration is set 0 second. The disable state is the default state.

The function is invalid when the TRI KeepOut is used in ordinary working modes.

When accessing to the **SN** item, the 18 digits serial number shows on the VFD display. For example: SN= 080010960121229001

Note: When accessing to the *Menu* item, you can press  or *Exit* to exit the menu operation.

No matter which function the instrument is performing, you can exit the function operation status by pressing the key .

4.6.2 Menu Function

The output state setup after the instrument powered on (>Out Memory)

This instruction is used to set the output state when the power supply is powered on. If you select the item *On*, the power supply will set the output to OFF state when the power supply is powered on. If you select the item *Off*, the output will remain the same state as last time you turned off the power supply.

Setting the Key Sound (Key Sound)

This instruction can switch on/off the buzzing sound when you press any key. If you select the item *On*, the buzzer will sound when any key was pressed. If you select *Off*, the buzzer will not sound when the keys were pressed. Default setting is the item *On*; the buzzer will sound when you press any key.

Setting the Baudrate (>Baudrate Set)

This instruction can change the communication baud rate of the power supply; the baud rate range is 4800bps, 9600bps, 19200bps, 38400bps. Before the communication, you must make sure that there is same baud rate between the power supply and the computer. Default baud rate is 9600bps.

Setting Password for Function Keys (>Key Lock Set)

This instruction can set a password (1 through 8 digits) to lock the function keys operation. After setting the password, the key *V-Set, Save, Recall, Menu* will be locked if no operation on keyboard in 60 seconds. Only if you put the correct password, the above keys are able to unlock. If you don't want to lock the function keys, please don't press any number key or just put **0** when you enter the *Key Lock Set* item, just press  key to unlock it.

List Operation (>List Set)

You can set every single-step value and duration time by new list operation so as to get different output list. The parameters of the list operation include the name of the list file which are input, input single step numbers (200steps at most), single step duration time (1mS at least) and the setting value of every single step.

When list operation is under *Continuous* mode, the power supply will begin the list operation until the list operation is finished or until receiving the next trigger signal.

Before editing the list, if you want to change the file storage format, please operate as the following steps:

- 1) Press the keys  and  to access to the menu function.

- 2) When VFD display screen shows the item **Menu Config**, press the key ▼ twice to select the item **List Set**, press the key **Enter** to confirm.
- 3) When VFD display screen shows the item **Load ListFile**, Press the key ▼ twice, select the item **Edit File Format**, press the key **Enter** to confirm.
- 4) When VFD display screen shows **8*25 Steps**, Press the key ▼, select a list mode you want from **1*200 Steps, 2*100 Steps, 4*50 Steps**, press the key **Enter** to confirm.
 1*200 steps means to set list file as 1X200 step
 2*100 steps means to set list file as 2X100 step
 4X50 steps means to set list file as 4X50 step
 8X25 steps means to set list file as 8X25 step
- 5) Press ▼ to select the item **Edit List File**, press the key **Enter** to confirm.
- 6) When VFD display screen show the item **Edit List File 1**, press the key ▲ and ▼ to select sequential number you want to edit, press the key **Enter** to confirm.
- 7) When VFD display screen show the item List x Steps= xxx, press numeric keys to set the total list steps. Press the key **Enter** to confirm.
- 8) When VFD display screen show the item **List File x Loop Mode**, press the key ▲ and ▼ to select operation mode:
Continuous means to start from the first step to the last step, stop the existing executing until next trigger
Loop Mode means to looping execute list file
Step Mode means excute one stpe after the trigger
- 9) When VFD display screen show the item **Step 1 Time= xxxxx mS**, press numeric keys to set time for step 1, press the key **Enter** to confirm.
- 10) When VFD display screen show the item **Step 1 Volt= xxxxx V**, press numeric keys to set voltage for step 1, press the key **Enter** to confirm.
- 11) When VFD display screen show the item **Step 1 Curr= xxxxx A**, press numeric keys to set current for step 1, press the key **Enter** to confirm.
- 12) Repeat step 9, 10, 11 to complete all steps in list file
- 13) Repeat step 5 to 15 to edit other list files if needed
- 14) Press ▼ to select **Load ListFile**, press the key **Enter** to confirm.
- 15) Press the key ▲ and ▼ to select sequential number you want to load, press the key **Enter** to confirm.
 The instrument is in the List mode. The VFD display screen shows OFF in the right when output is on. VFD display screen shows List1 in the right when output is off. Press the key **On/Off** to execute. Press key **Shift+2** or **Esc** to exit. Press key **Shift+2** direct to excute the last list file.
- 16) Under loop mode, the instrument looping executes automatically. Please find the following table at

Continuous Mode and Step Mode:

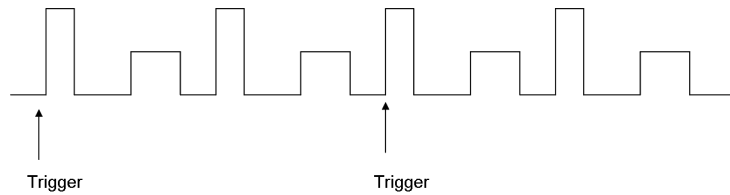

Diagram 4.2 Continuous Trigger (2 Times Cyclical)

When the list operation is under the **Step Mode**, the power supply will not be changed to next step until receiving a trigger signal. Please refer to the following diagram:

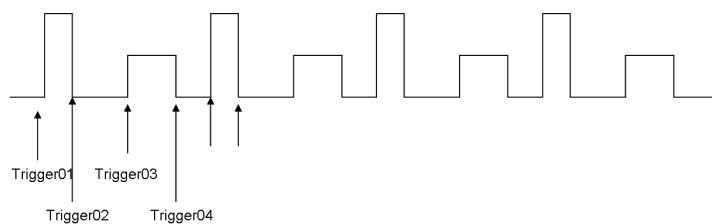

Diagram 4.3 Step Mode

Automatic Test (>Auto Test)

You can check if the equipment is qualified by editing the automatic test files, such as the value set, comparison parameters, delay time, inputting the step number (50 steps at most). 4 data of automatic test files can be edited.

How to edit automatic test files:

- 1) When the VFD display shows the item **Menu Config**, press the key ▼ tripple to select the item **Auto Test**, followed by pressing the key **Enter** to confirm.
- 2) When the VFD display shows the item **Load Atest File**, press the key ▼ and choose the item **Edit Atest File**, followed by pressing the key **Enter** to confirm.
- 3) When the VFD display shows the item **Edit Atest File 1**, press the keys ▲ and ▼ and select the sequential number that need to be edited, followed by pressing the key **Enter** to confirm.
- 4) When the VFD display shows **Atestx Steps= xxx**, press the numeric keys to set the total steps of list file, followed by pressing the key **Enter** to confirm.
- 5) When the VFD display shows **Step 1 Test Curr**, press the keys ▲ and ▼ to select one of the following testing types:
 - **Volt** means to test the output voltage.
 - **Curr** means to test the current.
 - **DVM** means to test voltmeter input.

- 6) When the VFD display shows **Step 1 Time= xxxxx S**, press the numeric keys to set the test duration, followed by pressing the key **Enter** to confirm. Please note that the duration range is 0.2S-25.5S. If delay time is set as 25.5S, the power supply will be automatically in the pause mode and go on executing only when another trigger is input.
- 7) When the VFD display shows **Step 1 Volt= xxxxx V**, press the numeric keys to set the voltage, followed by pressing the key **Enter** to confirm.
- 8) When the VFD display shows **Step 1 Curr= xxxxx A**, press the numeric keys to set the current, followed by pressing the key **Enter** to confirm.
- 9) When the VFD display shows **Step 1 Max= xxxxx X**, press the numeric keys to set the maximum value for the qualified test, followed by pressing the key **Enter** to confirm.
- 10) When the VFD display shows **Step 1 Min= xxxxx X**, press the numeric keys to set the minimum value for the qualified test, followed by pressing the key **Enter** to confirm.
- 11) Repeat from step 5 to step 10 to set all the other steps.
- 12) Repeat from step 2 to step 11 to edit other automatic test files according to your need.
- 13) Press the key **▼** to select the item **Load Atest File**, followed by pressing the key **Enter** to confirm.
- 14) Then the instrument enter into the automatic test mode, showing **AUTI** at the right upper corner of the VFD display and **OFF** at the right lower corner of the VFD display. That means to wait for a trigger.
- 15) There are three trigger modes for automatic test
 - Press the key **On/Off** to trigger.
 - Press the key **Shift+3** to trigger.
 - Become the high voltage level to the low voltage level by **Trig_in** at the rear panel and last more than 5mS.
- 16) When the power supply is having the automatic test, the word **Wait** will be showed at the right lower corner of the VFD display. When in pause mode, the word **Stay** will be showed at the right lower corner of the VFD display. When one test is finished, the test result **Pass** or **Fail** will be showed at the right lower corner of the VFD display.
- 17) When one test is finished, users can press the up-down keys to make one single step worked manually. At the moment, **step n** will be showed on the VFD display, indicating the step which is working; then **Han** is showed, indicating that the instrument is in hand-operated single step test state, followed by the test results being showed at the right lower corner of the VFD display.

4.7 Output On-Off Operation

When in front-panel operation, you can press the key **On/Off** to control the output state. The key **On/Off** does not affect the present setting values. When the TRI is enable, the key **On/Off** is invalid. When TRI is in OFF state, the TRI can be used to switch the OFF/ON state.

4.8 Remote Measurement Function

When the load consumes high current, the power supply will produce voltage drop in the connecting wire between power supply and load terminals. In order to guarantee the measurement accuracy, remote measurement terminals is installed at the rear-panel of the power supply. Users can measure the output terminals voltage of the instrument under test by these terminals.

Before performing the remote measurement function, you need to set the power supply as the remote measurement mode.

Please refer to the diagram 4.4 for the trigger terminals and measurement terminals.

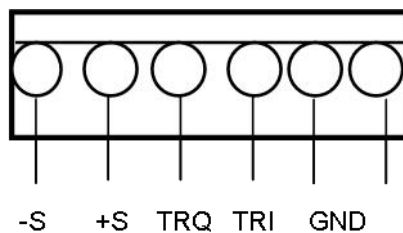

Diagram 4.4 Remote Measurement Terminals

-S and +S are remote measurement terminals; TRQ and TRI are trigger terminals, GND is ground terminal.

The TRQ is trigger output port under auto test mode. The TRQ is default as low voltage level. The TRQ provides +5V for external use when the trigger event happens.

As a multifunction extended port, TRI port is designed for trigger test in the list mode and auto test mode, TRI is also used to switch the ON/OFF state and used as TRI KeepOut port. The TRI is default as high voltage level of +5V. The TRI completes trigger when it change to low voltage level.

4.9 Milliohmmeter Function

The power supply provides the four-line electrical resistance measurement, just as showed in following diagram 4.5, which can measure accurately the low resistance and the maximum measurement resistance is 10Ω. In order to avoid the damage of the resistance under test, please make sure the resistance under test is within the measurement range.

Three measurement ranges can be optional: 0.1W, 1W, 10W.

Operation Method:

1) Press the keys **Shift** and $V/m\Omega$ (VFD display screen shows----,----mΩ, Range:0.1W) to measure the resistance.

2) Press the keys **Shift** and $0.1W$ or $1W$ or $10W$ to set different measurement range of Milliohmmeter.

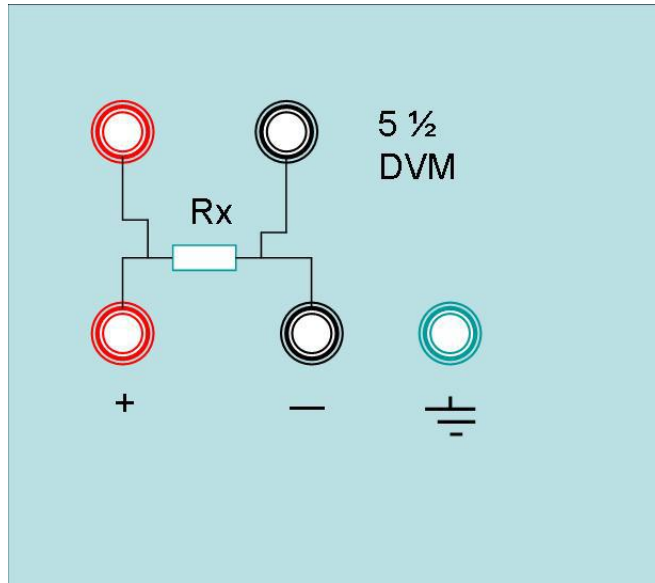

Diagram 4.5 Milliohmmeter Measuring Resistance

4.10 Voltmeter Function

The voltage of the instrument under test can be measured if the wires are connected together just as the diagram 4.6. The power supply can be worked as a voltmeter as long as it is not measuring the resistance. The accuracy of the voltmeter is 5 1/2.

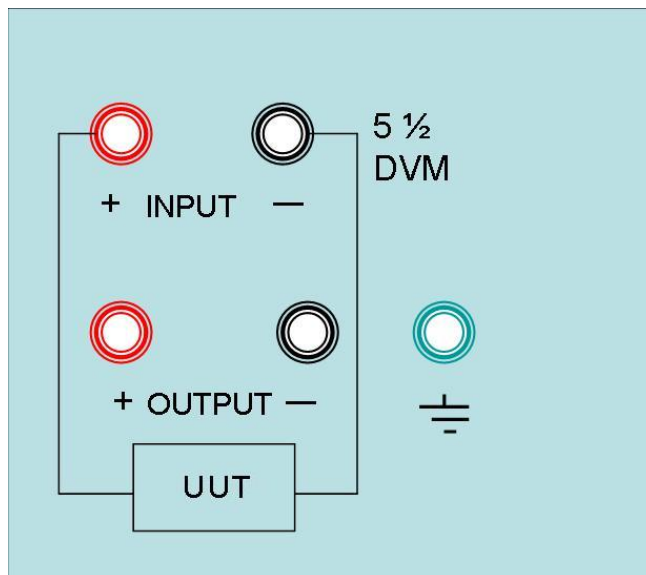

Diagram 4.6 Measuring the Voltage of the Instrument under Test

Chapter 5 Remote Operation Mode

The DB9 interface connector on the rear panel of the power supply can be transferred to RS232 interface through the voltage level convertor cable (M131), the following information will tell you how to use the computer to control the output of the power supply.

Before carrying out the remote operation mode, please use the voltage level converter cable (M131) provided by Saluki to connect the DB9 interface connector of the power supply and the RS232 interface connector of the computer for the communication. The M131 aslo can be replaced by the M132 (RS485) cable and M133 (USB) cable for different application.

5.1 M131/M132/M133 Communication Cable

The DB9 interface connector on the rear panel of power supply is TTL voltage level, you can use the communication cable (M131, M132 or M133) to connect the DB9 interface connector of the power supply with the computer's interface for the communication. Please refer to the following figures for interface connector.



Diagram 5.1 M131



Diagram 5.2 M133



Diagram 5.3 M132

Note: It will not work if you connect the DB9 interface connector of the power supply to the RS232 interface connector of computer directly by a standard RS232 cable. Please use M131 to connect them.

5.2 Communication between Power Supply and PC

The DB9 interface connector on the rear panel of the power supply can be transferred to the interface connector of the computer through the voltage level converter cable (M131/M132/M133). The following instructions can help you understand how to control the output of power supply by PC.

1. Communication Setting

Before using the remote operation mode, please make sure that the baudrate and communication address in power supply is the same as that in the computer software; otherwise, the communication will fail. You can change the baudrate and communication address from the front panel or from computer.

- (1) Baudrate: 9600(4800, 9600, 19200, 38400, which are selectable from the menu on the front panel of power supply).
- (2) Parity: NONE (NONE, EVEN, ODD)
- (3) Data bit: 8, Stop bit: 1(fixed value)

2. DB9 Serial Interface

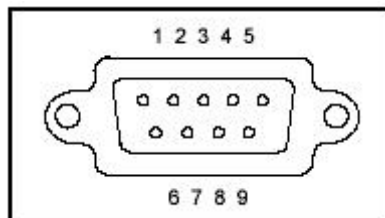

Diagram 5.4 DB9 Serial Interface

The output of DB9 interface on the rear panel of the power supply is TTL voltage level, so the voltage level convertor cable (M131/M132/M133) must be applied before connecting the DB9 interface with the serial interface on PC.

3. The Definition of the DB9 Interface

One end of the M131/M132/M133 cable is TTL voltage level, which is connected to the power supply. Another end is different.

The Definition of the DB9 Interface as follows:

Power Supply Side

TTL	
1	VCC (+5V)
2	RXD (receive)
3	TXD (send)
4	NC
5	GND (ground)
6	NC
7	NC
8	NC
9	NC

PC side

M131 (RS232)		
1	NC	<p>Notes: The pin 4 and 7 are paralleled. Each is provided +12V power.</p> <p>The pin 4 is provided +12V when the DTR is enable in process of programming.</p> <p>The pin 7 is provided +12V when the RTS is enable in process of programming.</p> <p>The DTR default is set enable in most serial communication controls.</p>
2	RXD (receive)	
3	TXD (send)	
4	VCC1	
5	GND (ground)	
6	NC	
7	VCC2	
8	NC	
9	NC	

M132 (RS485)		
1	A (+)	<p>Notes: Only to connect the pin 1 and pin 2 is able to get the RS485 communicate normally well.</p> <p>The pin 5 and pin 6 provides 5V/100Ma for external use.</p>
2	B (-)	
3	NC	
4	NC	
5	GND (ground)	
6	Vout (+5V)	

M133 (USB)		
1	VCC (+5V)	<p>Notes: The type A interface of the standard USB can be directly connected USB interface of the PC. The USB driver can be installed.</p>
2	-D	
3	+D	
4	GND (ground)	

Chapter 6 SCPI Communication Protocol

6.1 SCPI Communication Command Introduction

SPS8 series programmable DC power supply supports SCPI communication protocol.

SCPI communication protocol is a standard commands for programmable instruments, which defines a standard set of communication commands. Command for SPS8 series power supply can be divided into two categories: basic commands (IEEE-488.2 Common Command Set) and command specified by SPS8 series power supply.

SCPI command is ordered arrangements of tree constructs. Each command contains a number of strings (mnemonic) . Layers separated by a colon (:). At the top of the command in the command tree known as the "root shell" or simply "root." Access to the next command, you must specify a path. Ordered tree is structured as follows:

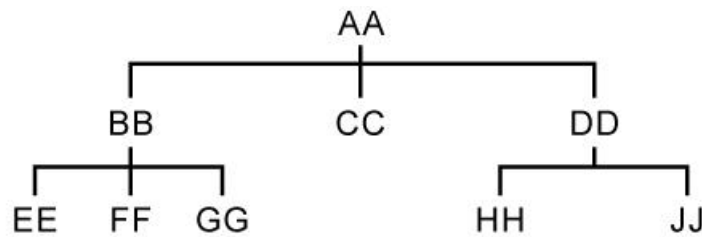

In the above table: AA represents the root path; BB, CC, DD represents the direct sub-path of root path AA. EE, FF, GG said that the path is a sub-sub-path under the BB. HH, JJ said that the path is a sub-sub-path under DD.

Command description:

- 1) `[:/] AA: CC` means the current root path for the AA, visit the CC under the AA.
- 2) `[:/] AA: BB: FF` means the current root path for the AA, visit the FF of the sub-path BB under the AA.
- 3) `[:/] AA: DD: HH` means the current root path for the AA, visit the HH of the sub-path DD under the AA.

This command can send more than one order in a message and use a semicolon (;) between each order.

Example:

`[:/]AA:BB:EE;FF;GG` means access to the EE, FF, GG under the BB.

`[:/]AA:BB:FF;:AA:DD:HH` means access to FF under the BB and HH under the DD.

SCPI language mnemonic (keywords) has two format: long format and short format. Short format is actually short for long format. It uses the following rules:

- Short format mnemonic is the first four characters of long format mnemonic. If the length of the long-form mnemonic characters less than or equal to 4, then the long mnemonic is the same as short

format mnemonic.

- If the length is greater than the length of 4 mnemonic, and the fourth character is a vowel, short mnemonic will discard the fourth vowel character and become three characters.

Example:

Short-type mnemonic of ERRor is ERR, rather than the ERRO.

Some command needs parameters, for example, setting value command. There is a space (ASCII code is 32) between the command and the first parameter.

Example:

Setup voltage value command **[:] VOLT 12.000**

There is a space (ASCII code is 32) between 12.00 and VOLT.

SCPI is case-insensitive, namely commands are not case sensitive and each command has an EOI end:

Instruction end <LF> (that ASCII code character '\n', that is, line breaks decimal ASCII code 10, hex 0x0A).

Note: All of the following commands to send back all require add <LF>. The following statement appears in [] represents the characters can be written in commands, or you can not write.

6.2 Command Introduction of SPS8 Power Supply

6.2.1 Basic command (IEEE-488.2 Common Command Set)

Basic command includes all general functions in IEEE-488.2. These functions are usually applied to support the IEEE488.2 standard measuring instruments. The group command begin at an asterisk (*) and has no hierarchy.

Command * IDN?

Command * IDN is used to read the relative information of power supply, including manufacturer, product model number, serial number, and version number.

Return command: return parameter contains four fields separated by comma(,).

Example:

Sending command * **IDN?**, the corresponding expressed as a hexadecimal is 0x2A 0x49 0x44 0x4E 0x3F 0x0A, if return command is SALUKI,SPS811, 080010960121229001, V1.0, it means:

SALUKI	manufacturer
SPS811	product model number
080010960121229001	product serial number
V1.0	fireware version number

6.2.2 System Command

Commands described in this section are under the root path [:] SYSTem commands. The following commands are used short-type mnemonic format.

Command [:]SYSTem:ERRor?

Command [:]**SYSTem:ERRor** is used to read the error code and error message.

Return command: Error code, error message.

Example:

If you send command ***[:]SYST:ERR?***, then return command ought to be "0, 'No Error'", or "50, 'Error Para Count'", or "70, 'Invalid Command'" etc..

Command *[:]SYSTEM:REM*

Command ***[:]SYSTEM:REM*** is used to set remote control mode, namely the PC control mode.

Return command: None

Example:

If you send command ***[:]SYSTEM:REM***

After sending command successfully, the power supply has been in the remote control mode, "REM" characters appears in the right corner front panel and the front panel operation is not valid. And please return the front panel control model by pressing the key Shift + the number 7, or sending the command ***[:]SYST:LOC***.

Command *[:]SYSTEM:LOC*

Command ***[:]SYST:LOC*** is used to set the front panel control mode.

Return command: None

Example:

Sending command ***[:]SYST:LOC*** if the power supply in the remote control (PC) mode. After sending successfully, the power has been in the front panel control mode while "REM" disappears from the right corner of the front panel.

Command *[:]SYSTEM:SENSe <bool>*

Command ***[:]SYST:SENSe <bool>*** is used to set the power is under remote measurement.

Return command: None

Parameters: bool-type parameter (0-OFF, 1-ON)

Example:

Sending command ***[:]SYST:SENS 1***, if sending successfully, the power supply is set in the remote measurement.

6.2.3 Measurement Command

Commands described in this section are under the root path ***[:]MEASure*** commands. The following commands are used short-type mnemonic format.

Command *[:]MEASure: VOLTage?*

Command ***[:]MEASure: VOLTage?*** is used to read output voltage value.

Return command: Numeric

Return parameters Unit: V

Example:

Sending command ***[:]MEAS: VOLT?***, if return command is 12.560, it means the present output voltage is

12.560V.

Command [:]MEASure:CURRent?

Command *[:]MEASure:CURRent?* is used to read output current value.

Return command: Numeric

Return parameters Unit: A

Example:

Sending command *[:]MEAS:CURR?*, if return command is 1.245, it means the present output current is 1.245A.

Command [:]MEASure:DVM?

Command *[:]MEASure: DVM?* is used to read input voltage of the voltmeter in the power supply.

Return command: Numerical

Return parameters Unit: V

Example:

Sending command *[:]MEAS:DVM?*, if return command is 12.560, it means the current voltmeter input voltage is 12.560V.

Command [:]MEASure:VCM?

Command *[:]MEASure:VCM?* is used to read three value: output voltage value, output current value, and input voltage of the voltmeter in the power supply.

Return command: Numerical list, using corner(,) among the three values

Return parameters Unit: V and A

Example:

Sending command *[:]MEAS:VCM?*, if return command is 10.0000,0.00000,5.0000, it means the present output voltage is 10.0000V, the present output current is 0.00000A, and the current voltmeter input voltage is 5.0000V.

6.2.4 Setting Command

Command [:]OUTPut <bool>

1. Command *[:]OUTPut <bool>* is used to set the output ON/OFF status.

Return command: None

Parameters: bool-type parameter (0-OFF, 1-ON)

Example:

If sending command *[:]OUTP 1*, the power supply output is ON if you set successfully.

2. Related command *[:]OUTPut?*, to query output status of power supply.

Return command parameter: <bool>.

Command [:] MODE <mode>

1. Command *[:]MODE <mode>* is used to set the power operating mode. That is, command set mode or sequential list mode, or milliohmmeter mode.

Parameter: mode has three following modes,

FIXed	command set mode
LIST	sequential list mode
DRM	milliohmmeter mode

Return command: None

Example:

Sending command ***[:]MODE LIST***, the power supply is in sequential list mode.

2. Related command ***[:] MODE?***, to query working mode of power supply.

Return command parameter: <mode>

Command *[:]VOLTage <Value>*

1. This command is used to set the voltage value of power supply.

Parameters: numeric |MAX|MIN

Unit: V

Return Command: None

Example:

1) Sending command ***[:]VOLT 30***

Means to set the voltage value of the power supply is 30V.

2) Sending command ***[:]VOLT MAX***

Providing the maximum output voltage is 76.000V, it means to set the voltage value is the maximum voltage 76.000V.

3) Sending command ***[:]VOLT MIN***

Providing the minimum output voltage is 0.000V, it means to set the voltage value is the minimum voltage 0.000V.

2. Related Command ***[:]VOLT? MAX|MIN***, the command is used to query the setup voltage value, the maximum setup voltage value and the minimum setup voltage value.

Return command parameters: numeric

Example:

1) If you want to query the setup voltage value, please send command ***[:]VOLT?***, if the return command is 10.0000, it means the setup voltage of power supply is 10.0000V.

2) If you want to query the maximum setup voltage value, please send command ***[:]VOLT? MAX***, if the return command is 76.0000, it means the maximum setup voltage value of power supply is 76.0000V.

3) If you want to query the minimum setup voltage value, please send command ***[:]VOLT? MIN***, if the return command is 0.0000, it means the minimum setup voltage value of the power supply is 0.0000V.

Command *[:]CURRENT <Value>*

1. This command is used to set the current value.

Parameters: numeric |MAX|MIN

Unit: A

Return command: none

Example:

1) Sending command **[:]CURR 3**, it means to set the current value as 3A.

2) Sending command **[:]CURR MAX**

Providing the maximum setup current value of the power supply is 2.0000A, it means to set the present current value as the maximum current value 2.0000A.

3) Command sent **[:]CURR MIN**

Providing the current minimum setup current is 0.0000A, it means to set the present current as the minimum current 0.0000 A.

2.Related Command **[:]CURR? MAX|MIN**, the command used to query the setup current value, the maximum setup current value and the minimum setup current value

Return command parameters: numerical value

Example:

1) If you want to query the setup current value, please send command **[:]CURR?**, if the return command is 1.0000, it means the setup current of power supply is 1.0000A.

2) If you want to query the maximum setup current value, please send command **[:]CURR? MAX**, if the return command is 2.0000, it means the maximum setup current value of power supply is 2.0000A.

3) If you want to query the minimum setup current value, please send command **[:]CURR? MIN**, if the return command is 0.0000, it means the minimum setup current value of the power supply is 0.0000A.

Command [:]VOLTage:PROTection <Value>

1. This command is used to set the upper limit voltage of the power supply, namely the maximum output voltage.

Parameters: numeric |MAX|MIN

Unit: V

Return command: none

Example:

1) If sending command **[:]VOLT:PROT 30**, it means to set 30.000V as the upper limit voltage of the power supply.

2) If sending command **[:]VOLT:PROT MAX**, it means to set the upper limit voltage as the maximum output voltage value of the power supply.

3) If sending command **[:]VOLT:PROT MIN**, it means to set the upper limit voltage as the minimum output voltage value of the power supply.

2. Related command **[:]VOLTage:PROTection? [MAX]**, it means to query the upper limit voltage

Return command parameters: numerical value

Example:

1) If sending command **[:]VOLT:PROT?**, If the return command is 20.000, it means the upper limit voltage of

the power supply is 20.000V.

2) If sending command `[:]VOLT:PROT? MAX`, If the return command is 76.000, it means the maximum setup voltage value of the power supply is 76.000V.

6.2.5 List Operation Related Command

Command `[:]LIST:AREA <num>`

1. This command is used to set the list location division mode.

Parameter: 1|2|4|8

1. Set 1 file of 200 list steps in the list operation
2. Set 2 files of 100 list steps in the list operation
4. Set 4 files of 50 list steps in the list operation
8. Set 8 files of 25 list steps in the list operation

Example:

If sending command sent `[:]LIST:AREA 8`, it means to set 8 files of 25 list steps.

2. Related command `[:]LIST:AREA?`, it means to query the location division mode of the list operation.

Return parameters: <num>

Command `[:]LIST:RCL <num>`

This command is used to recall the saved files from a certain location so as to make them executed in the list.

Parameter: 1~8

Return command: none

Example:

If sending command `[:]LIST:RCL 2`, it means to recall the list file from the storage register location 2 and make the file executed.

Command `[:]LIST:COUNt <count>`

1. This command is used to set the step number of list.

Parameter: count range : 1~200

Return command: none

Example:

If sending command `[:]LIST:COUN 20`, it means the step number of the list is set as 20.

2. Related command `[:]LIST:COUNt?`, it means to query the step number of the current list.

Return parameter: <count>

Command `[:]LIST:MODE <mode>`

1. This command is used to set the working mode of the list.

Parameters: *mode* has 3 types:

CONTinuous: continuous mode

STEP: 1 step mode (once mode)

LOOP: loop mode

Return command: none

Example:

If sending command `[:]LIST:MODE CONT`, it means the working mode of list files is set as continuous mode.

2. Related command `[:]LIST:MODE?`, it means to query the working mode of the current list.

Return parameters: <mode>

Command `[:]LIST:VOLTage <count>,<value>`

1. This command is used to set the setup voltage value of the appointed step in the list.

Parameter: *count* is appointed step number; *value* is the setup voltage.

Unit: V

Return command: none

Example:

If sending command `[:]LIST:VOLT 1,5`, it means to set the setup voltage value of the first step of the list file as 5.000V.

2. Related command `[:]LIST:VOLTage? <count>`, it means to query the setup voltage value of the appointed step in the list.

Return parameters:<value>

Example:

If sending command `[:]LIST:VOLT? 1`, it means to query the setup voltage value of the first step in the current list.

Command `[:]LIST:CURREnt <count>,<value>`

1. This command is used to setup current value of the appointed step in the list.

Parameters: *count* is appointed step number; *value* is the setup current.

Unit: A

Return command: none

Example:

If sending command `[:]LIST:CURR 1,2`, it means to set the setup current value of the first step in the list as 2.000A.

2. Related command `[:]LIST:CURREnt? <count>`, it means to query the setup current value of the appointed step in the list.

Return parameter: <value>

Example:

If sending command `[:]LIST:CURR? 1`, it means to query the setup current value of the first step in the current list.

Command `[:]LIST:WIDTh <count>,<time>`

1. This command is used to set the delay time of the appointed step in the list.

Parameters: *count* is the appointed step number; *time* is the setup delay time.

Unit: mS

Return command: none

Example:

If sending command `[:]LIST:WIDTh 1,2000`, it means to set the delay time of the first step of the list file as 2000mS.

2. Related command `[:]LIST:WIDTh? <count>`, it means to query the delay time of the appointed step in the current list.

Return parameters: <time>

--- END OF DOCUMENT ---