



S3531 Series Spectrum Analyzer

User Manual

Saluki Technology Inc.

The manual applies to the spectrum analyzer of the following models:

- S3531A spectrum analyzer (9kHz-1.8GHz).
- S3531B spectrum analyzer (9kHz-3.0GHz).

Standard Accessories of S3531 spectrum analyzer:

Item	Name	Qty
1	Main Machine	1 Set
2	Power Cord	1 pcs
3	CD	1 pcs

Options of the S3531 spectrum analyzer:

Option Number	Item
S3531-01	100kHz - 1.5GHz/ 100kHz – 3.2GHz tracking source
S3531-02	Dual source: tracking source + normal signal source (100kHz – 1.8GHz, 100kHz – 3GHz)
S3531-03	FFT 1Hz RBW. Extend the RBW to 1Hz – 3MHz, standard RBW is 10Hz – 3MHz
S3531-04	Audio demodulation & Measurement
S3531-05	Frequency discriminator
S3531-06	RFID test box
S3531-07	EMI near field probe

Preface

Thanks for choosing S3531 series spectrum analyzer produced by Saluki Technology Inc. Please read this manual carefully for your convenience.

Manual No.

S3531-03-01

Version

Rev01 2017.03 Saluki Technology

Manual Authorization

The information contained in this Manual is subject to change without notice. The power to interpret the contents of and terms used in this Manual rests with Saluki.

Saluki Tech owns the copyright of this Manual which should not be modified or tampered by any organization or individual, or reproduced or transmitted for the purpose of making profit without its prior permission, otherwise Saluki will reserve the right to investigate and affix legal liability of infringement.

Product Quality Assurance

The warranty period of the product is 18 months from the date of delivery.

Product Quality Certificate

The product meets the indicator requirements of the manual at the time of delivery. Calibration and measurement are completed by the measuring organization with qualifications specified by the state, and relevant data are provided for reference.

Quality/Environment Management

Research, development, manufacturing and testing of the product comply with the requirements of the quality and environmental management system.

Precautions



Warning

"Warning" indicates danger. It reminds the user to pay attention to a certain operation process, operation method or similar situations. Noncompliance with the rules or improper operation may result in personal injuries. You must fully understand the warning and all the conditions in it shall be met before the next step



Attention

"Attention" indicates important prompts and no danger. It reminds the user to pay attention to a certain operation process, operation method or similar situations. Noncompliance with the rules or improper operation may result in damage to the instrument or loss of important data. You must fully understand the caution and all the conditions in it shall be met before the next step.

Contacts

Service Tel:	886.2.2175 2930
Website:	www.salukitec.com
Email:	info@salukitec.com
Address:	No. 367 Fuxing N Road, Taipei 105, Taiwan (R.O.C.)

Content

1	Overview	8
1.1	Brief Introduction	8
1.2	Key Feature	8
1.3	Typical Applications	8
1.4	Measurement Functions	8
2	Safety Instructions	10
2.1	Device safety	10
2.2	Precautions on personal safety	11
3	Brief Instruction	12
3.1	Unpacking.....	12
3.1.1	Model Confirmation	12
3.1.2	Appearance Inspection.....	12
3.1.3	Operating Environment	12
3.1.4	Electrostatic Protection.....	13
3.1.5	First Power Up.....	13
3.2	Routine Maintenance.....	14
4	Front and Rear Panels	8
4.1	Front Panel	8
4.1.1	Function Keys.....	8
4.1.2	Input Keys	9
4.1.3	Enter key	10
4.1.4	Front Panel Interfaces	10
4.2	Rear Panel.....	11
4.3	UI	11
5	Typical Operation	8
5.1	Prepare.....	8
5.2	Continuous Signal Measurement.....	8
5.3	Measure two signals with small frequency interval.....	9
5.3.1	Resolving Two Signals of Equal Amplitude.....	9
5.3.2	Resolving Signals of Different Amplitudes.....	11
5.4	N dB Bandwidth Measurement	13
5.5	Adjacent Channel Power	14

5.6	Channel Power Measurement	15
5.7	Occupied Bandwidth Measurement	16
5.8	Use Pre-amplifier to Capture Weak Signals	17
5.9	Harmonic Distortion Measurement	17
5.10	TOI Distortion Measurement	18
6	Menu Description	21
6.1	Menu Structure	21
6.2	AMPT	23
6.3	BW	24
6.4	Detect	25
6.5	Demod	26
6.6	FILE	27
6.7	FREQ	28
6.8	Marker	30
6.9	Marker->	32
6.10	[Marker Function]	33
6.11	Meas	34
6.12	PEAK	37
6.13	Print	38
6.14	SAVE	38
6.15	SOURCE	39
6.16	Span	41
6.17	Sweep	42
6.18	System	43
6.19	Trace	44
6.20	Trig	46
7	Remote Control	47
7.1	OS supported	47
7.2	Software Installation Procedures	47
7.3	Connection	50
7.3.1	USB Port Connection	50
7.3.2	LAN connection	51
7.4	UI	52
7.4.1	Key Zone	52
7.4.2	Softkey Zone	52
7.4.3	SCPI control Zone	53

7.4.4	Display Zone	53
7.4.5	Menu Bar.....	53
8	Specification Details.....	56
8.1	Frequency.....	56
8.2	Amplitude.....	56
8.3	Input /Output.....	56
8.4	RBW	57
8.5	DANL (0dB attenuation , RBW=1Hz)	57
8.6	Phase Noise	57
8.7	Sweep Time.....	57
8.8	Spurious Response	58
8.9	Tracking Generator (Option).....	58
8.10	General.....	58
9	Appendix A Programming Manual.....	59

1 Overview

1.1 Brief Introduction

S3531 is an economic spectrum analyzer for 3GHz span. It has good specification and multiple functions within a good looking small box. It is a good solution for RF R&D, test, maintenance and education.

1.2 Key Feature

- Frequency range
 - S3531A: 9kHz – 1.8GHz
 - S3531B: 9kHz - 3.0GHz
- DANL: < - 148 dBm for full span, min. <-158dBm (typ.)
- Phase noise: < - 100 dBc/Hz at 100 kHz offset
- Optional dual source, tracking source and normal source up to 3GHz
- Standard pre-amplifiers.
- SCPI supported.

1.3 Typical Applications

- EMI debugging
- RF design debugging
- Interference analysis (spectrogram)
- Education and training
- Spectrum monitoring
- Signal location
- RF transmitter testing and maintenance

1.4 Measurement Functions

- Spectrum Analyzer
- Interference Analyzer (Waterfall diagram)
- Field Strength
- Limit Line
- User-defined mask
- Channel Power
- OBW(Occupied Bandwidth)
- ACPR (Adjacent Channel Power Ratio)
- AF/FM demodulation

- Audio demodulation
- Scalar network measurement

2 Safety Instructions

Please read safety instruction carefully and Strictly follow !

We will spare no efforts to ensure that production process comply with latest safety standards so as to safeguard the safety of our users. The design and tests of our products and accessory equipment comply with relevant safety standards. We have established quality assurance system so that we can better supervise product quality and ensure that all products accord with standards in the system. To maintain the sound state of equipment and ensure safe operation, please comply with the following instruction. Contact us if you have any questions.

It is also your responsibility to use this product in correct manner. Suitable for industrial, laboratory and field uses, this equipment, however, must be used in correct manner so as to prevent personal injuries and property damages. For problems caused by misuses, liabilities rest on users. By proper use, it means that users should use this product according to prescriptions in the product document and in the required conditions. As sufficient expertise is required, only professional technicians and people that have been strictly trained and have mastered necessary skills are qualified to use this product. Please keep safety manual and product document in a proper manner, and deliver them to the end user. To forestall personal injuries and property loss, please abide by these safety instructions. Prior to using this product, please read carefully and comply with these instructions accordingly.

2.1 Device safety

- 1) Use designated packing container in shipping and avoid falling or violent collisions in moving, which may cause damages to the device.
- 2) Use AC-DC adapter/ power cord shipped with the device to supply power/charge to the product. Using other power adapters/power cord may cause damages to internal hardware.
- 3) Ensure that power supply is well connected to the ground to prevent damages to the device caused by poor connection or false connection.
- 4) Injection of DC signal into input end is prohibited. Signal power needs to be lower than 0.5W. If not, damage to the device may occur.
- 5) Both insertions of objects into the gap of the device housing and dumping of liquids over device housing or into device are prohibited, which may cause short circuit, electric shock, fire or personal injuries.
- 6) Notches or gaps in the device, designed to help internal ventilation and whereby prevent overheat, must not be covered. The device must not be put on couch, wrapped with carpet, or placed in airtight housing unless ventilation is good
- 7) This device must not be placed on radiator, dish heater and other heating devices. Ambient temperature must not surpass the maximal temperature prescribed in this manual
- 8) Attention: Once this device is on fire, it may release toxic gases or liquids.
- 9) Please do not disassemble the instrument without permission
- 10) If any unusual phenomenon like smoke, smell, sparkle etc, occurs during start up, operation, please immediately turn off the instrument, cut off the power and contact Saluki.
- 11) Keep good ventilation and do not block the vent holes on the instrument. Check and clean the vent holes during routine maintenance.
- 12) Operate and store the instrument in the environment as required. Explosive matters are strictly forbidden
- 13) Pay more attention to ESD protection. Please use conductive mat and wrist ring during operation

2.2 Precautions on personal safety.

- 1) When moving the device, use proper tools and move the device softly so as to avoid personal injuries caused by the falling of the device.
- 2) Device should be proper grounded so as to prevent personal injuries caused by poor or false grounding
- 3) When cleaning the device, please unplug the device to avoid electric shock. Use dry or moist soft cloth to clean the device. Do not clean the internal of the device.
- 4) Before using this device, personnel need to be trained. When using the device, concentration is required. Operation by unqualified people may cause personal injuries and property losses.
- 5) Use of this device when power line is broken is prohibited. Regular check on power line is necessary. Proper measures should be taken to keep power line in good state and prevent stumble and electric shock.
- 6) Field use of the device when there is lightning is prohibited, which may cause personal injuries and property loss.

3 Brief Instruction

3.1 Unpacking

3.1.1 Model Confirmation

After opening the packing box, you will see the following items:

- S3531 spectrum analyzer x 1
- Three-wire Power Cord x 1
- CD x 1

Please check the above items against the Purchase Contract and the Packing List. If any problem, please contact Saluki and we will deal with the problem as soon as possible.

Attention

Since the instrument and packing box are very heavy, please join force with another person to handle with care.

3.1.2 Appearance Inspection

Inspect carefully whether the instrument has any damage during transportation. If the instrument has obvious damage, it is strictly forbidden to be powered on. Please contact Saluki and we will repair or exchange it be as soon as possible.

3.1.3 Operating Environment

Refer to the part of environment adaptability in the technical specifications of appendix 1. In addition, pay special attention to the following requirements:

Power supply: 110 – 220V $\pm 15\%$, 50Hz – 60Hz $\pm 5\%$, 20W

Power socket: a three-wire supply socket that must be grounded reliably.

Instrument power cord: packed three-wire power cord

Warning

Before connecting the spectrum analyzer with the power supply, please carefully verify if the power supply voltage. Otherwise, it is much possible to damage the instrument or even cause personal injuries.

**Warning**

To prevent or reduce the possible damage to the internal hardware of the spectrum analyzer due to the mutual interference caused by several sets of equipment through the power supply, especially the peak pulse interference caused by high-power equipment, it is best to use a 220V/110V AC stabilized-voltage power supply to supply power for the spectrum analyzer.

**Warning**

Bad grounding or failure of the power supply may cause damage to the instrument, even personal injury. Before connecting the power supply of spectrum analyzer, make sure ground wires of the instrument and its power supply are in good contact.

Use a power socket with protective grounding and do not substitute the protective ground wire with an external cable.

3.1.4 Electrostatic Protection

ESD can damage or destroy electronic components and equipment. Antistatic measures are usually taken to prevent ESD damage: conductive table-mat and wrist-strap combination as well as conductive floor-mat and heel-strap combination. Both types, when used together, provide a significant level of ESD protection. Among the two, only the table-mat and wrist-strap combination provides adequate ESD protection when used alone. To ensure user safety, the static-safe accessories must provide at least 1 M Ω resistance to ground.

Please use the following antistatic measures correctly to reduce the damage of electrostatics:

Ensure all the instruments are grounded correctly to prevent the electrostatics being generated.

Before touch the joint and core wire or do any assembly operation, do wear antistatic wrists or take other antistatic measures.

**Warning**

The above antistatic measures shall not be taken where the voltage is larger than 500V.

3.1.5 First Power Up

- 1) Connect the provided power cord instrument end to the power socket on rear panel.
- 2) Ensure the AC power is compliant to requirement.
- 3) Connect the other end to AC power
- 4) Press the power button on front panel.
- 5) Screen lighted and it will take around 30 sec to run the self-test and adjust. Waiting for the process to be done.
- 6) For an accurate measurement, please warm up the spectrum analyzer for 30min before measurement.

3.2 Routine Maintenance

It is required to check and clean the instrument after a period of use. Please proceed as the following procedures:

- 1) Shut down.
- 2) Unplug the power cord.
- 3) Use a clean and soft cloth with detergent to wipe the keys gently.
- 4) Wipe up the display with a clean and soft cloth.
- 5) Check other sides of the instrument and ensure no damage
- 6) Clean other sides of the instrument with a soft cloth. Please pay attention to the ports and interfaces, do not clean them and avoid any scratches may impact the measurement in future.
- 7) Plug in the power cord after the display is dried out.



Attention

There is a layer of Anti Static Coatings (ASC) applied on the surface of the display screen, so never use the cleaner containing fluoride, acidic cleaner or alkali cleaner. Never spray cleaner over the display panel, otherwise the cleaner may seep into and damage the instrument.

4 Front and Rear Panels

4.1 Front Panel

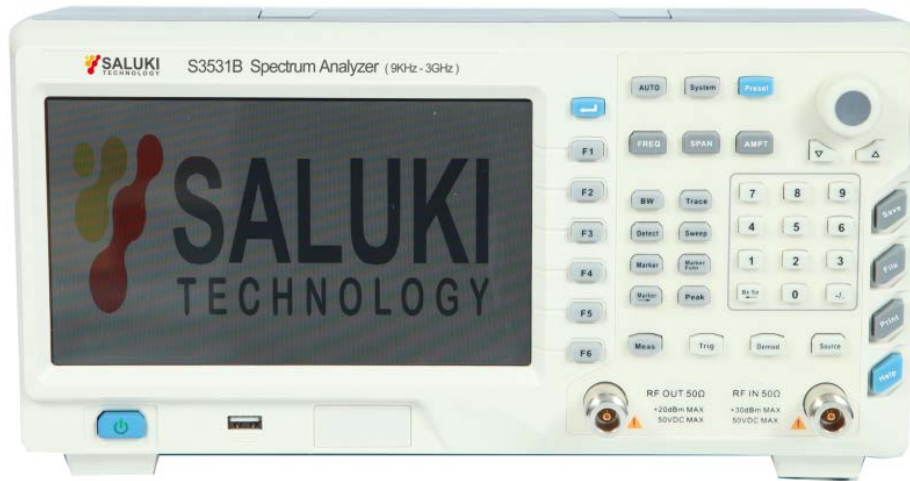

Figure 4-1 S3531 Front Panel

No.	Description	No.	Description
1	LCD screen	7	Number Key Zone
2	Soft Keys	8	Tracking Source Output
3	Function Keys	9	RF IN port
4	Preset Key	10	USB port
5	Power Button		
6	Knob and navigation keys		

4.1.1 Function Keys

Keys	Function
AUTO	Auto measurement
System	System settings
Preset	Preset the instrument
FREQ	Frequency settings. Include Start Frequency, Stop frequency, center frequency
SPAN	Frequency span setting
AMPT	Amplitude Settings. Include Reference level, attenuator, pre-amplifier, scale settings.
BW	Bandwidth Include RBW, VBW
Trace	Trace settings: Include detector, max hold, min hold settings
Detect	Set the detector

Keys	Function
Sweep	Sweep settings. Include sweep point, sweep time settings.
Marker	Marker Functions
Marker Fctn	Marker analysis functions
Marker->	Take marker as a reference to move the trace
Peak	Peak search functions
Meas	Measurement functions, spectrum, ACPR, OBW included
Trig	Trigger settings
Demod	Demodulation functions, AM/FM included
Source	Setting of the tracking source or normal source

4.1.2 Input Keys

S3531 has numeric keys, knob and navigation keys to do the input.

4.1.2.1 Knob and navigation keys



- **Knob functions:**
 - When entering numbers, step up (clockwise) or down (anticlockwise) the instrument parameters as specified;
 - To move the selection bar in the Focus area (such as list);
 - To move markers or limit lines on the screen;
 - When pressed, it has the same function with Enter key.
- **Up/down key functions**
 - To increase or decrease instrument parameters in steps;
 - To roll up and down the items in the list;
 - To vertically move the selection bar in the table;
 - To move the scroll bar in windows or dialogs with the vertical scroll bar.

4.1.2.2 Numeric Keyboard



- Number 1 – 9

To input number parameters.

- Decimal point

To inset one "." at cursor position.

- "-" key

To change symbols(+,-) of numeric parameters.

- Backspace key

When alphanumeric character has been entered, this key will delete the character at the left of the cursor;

If no input field is active, this key will cancel recently entered value and restore the previous value. Therefore, users can switch between two values (such as frequency span).

4.1.3 Enter key



- To terminate the input of a dimensionless number and set it as a new value;
- For other inputs, this key may be used as unit key including "Hz/dB";

4.1.4 Front Panel Interfaces

4.1.4.1 USB



Use for external storage, U disk

4.1.4.2 RF IN



RF IN port is a 50ohm N type female port. This port will be connected to a test cable or an antenna to collect signal to be tested.

Damage level of this port is 30dBm and 50VDC

4.1.4.3 RF Out



RF IN port is a 50ohm N type female port. This port is used to output tracing signal and arbitrary signal. Need to purchase option 001

4.2 Rear Panel



Figure 4-2 S3531 Spectrum Analyzer Rear Panel

No.	Description	No.	Description
1	10MHz Reference IN/OUT BNC	5	LAN port RJ45
2	External Trigger BNC	6	RS232 serial port
3	Ear phone port	7	VGA port
4	USB A type	8	Power port

4.3 UI

1	Display format	9	State bar
2	Scale	10	Center frequency
3	Reference level	11	RBW
4	Detector	12	Information bar
5	Attenuator	13	VBW

1	Display format	9	State bar
6	Time	14	Span
7	Marker	15	Sweep Time
8	Marker information	16	Soft Menu

5 Typical Operation

This chapter will show how to use S3531 series spectrum analyzer, following functions are included:

- Continuous signal measurement
- Measure two signals with small frequency interval
- N dB bandwidth measurement
- Chanel power measurement
- Occupied bandwidth measurement
- Weak signal capture
- Harmonic distortion measurement
- TOI distortion measurement

5.1 Prepare

Press the power button to turn on S3531 spectrum analyzer.

This chapter means to show the basic operations of S3531 spectrum analyzer. Signal generators are used to simulate the signal source. Signal can be transmitted/received via a test cable or a pair of antennas.

Warning

Before any test, please ensure power level of input signal should not exceed +30dBm(1W), otherwise the instrument would be damaged.

5.2 Continuous Signal Measurement

- 1) Set S1103 signal generator to generate a 300MHz, -10dBm continuous signal. Please refer to document S1103-03-01 for more details to set S1103 signal generator.
- 2) Connect S1103 signal generator output to S3531 series spectrum analyzer input. Or use antennas to transmit/receive the signal.
- 3) Preset the Instrument
 - Press **【PRESET】** key . The instrument will return to default settings。
- 4) Frequency settings
 - Press **【FREQ】** key.Frequency menu will show on the screen.
 - Select [Center Frequency].
 - Use number keys, knob or up/down arrow key to set the center frequency to 300MHz
- 5) Span setting
 - Press **【SPAN】** key . Span menu will show on the screen
 - Select [Span]
 - Use number keys, knob or up/down arrow key to set span to 5MHz

By now the signal is show in the screen as shown in figure 5-1.

- 6) User a marker to measure the frequency and amplitude of the signal
 - Press **【Marker】** key→[Marker]→1, activate Marker1.
 - Press **【Peak】** key, the marker will be moved to signal peak automatically. Marker information will be shown in up-right corner.
- 7) Readout the test result

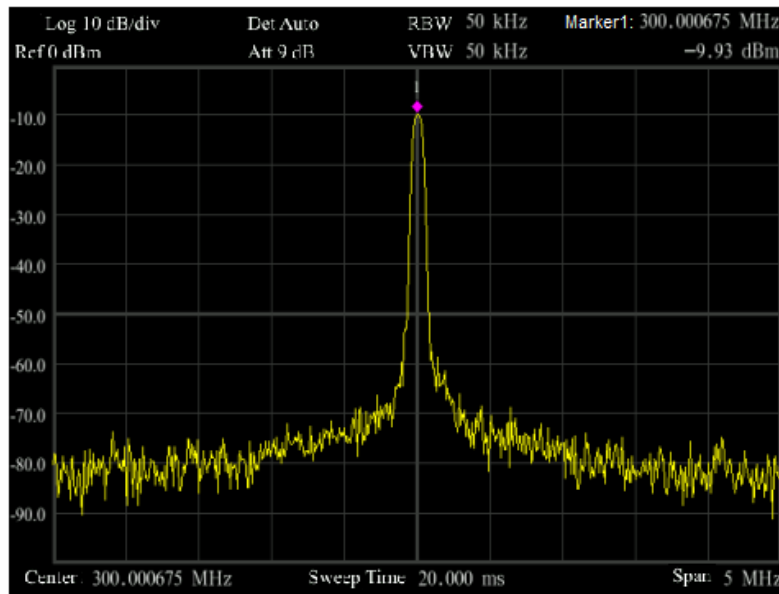

Fig 5-1: Continuous signal Test result

5.3 Measure two signals with small frequency interval

Signal resolution is determined by the resolution bandwidth (RBW). When a signal passes through the filter, the spectrum analyzer will use the signal to sweep and display the band pass shape of the IF filter. So, when the spectrum analyzer receives two signals with equal amplitude and close frequency interval, the top of one band-pass filter waveform nearly covers another one, making two signals like one. If two signals of different amplitudes but close frequency interval, small signals may be totally hidden by large signals.

5.3.1 Resolving Two Signals of Equal Amplitude

Generally, to resolve two signals of equal amplitude, the resolution bandwidth must be less than or equal to the frequency interval of the two signals. For example, to resolve two signals of equal amplitude and a frequency interval of 100 kHz, the resolution bandwidth of the spectrum analyzer should be set less than or equal to 100 kHz.

Example

Take measuring two signals of equal amplitude with a frequency interval of 100kHz as an example, the measurement steps are as follows:

- 1) Connect the outputs of two signal generators to the spectrum analyzer RF input port using a T-shaped connector, as shown in Figure below.



Fig 5-2: Equipment Connection for 2 signal capture

- 2) Set the frequency of one signal generator to 1800.4995MHz and the other to 1800.5005MHz. Set the output amplitude of both to -20dBm. Respectively adjust the signal output amplitude of two signal generators and view the signals displayed on the spectrum analyzer to make the displayed amplitudes of two signals equal.
- 3) Set up the spectrum analyzer to view signals.
 - Press **【Preset】** ,
 - Press **【Freq】** ,
 - Select [Center Freq] and input 1800[MHz],
 - Press **【Span】** key and select [Span], input 50[kHz];
 - Press **【BW】** , select [Res BW Auto Man], input 1[kHz].

At this moment, 2 signal peak can be seen on the screen of the spectrum analyzer but the 2 signals are not clearly separated, as shown in Figure below

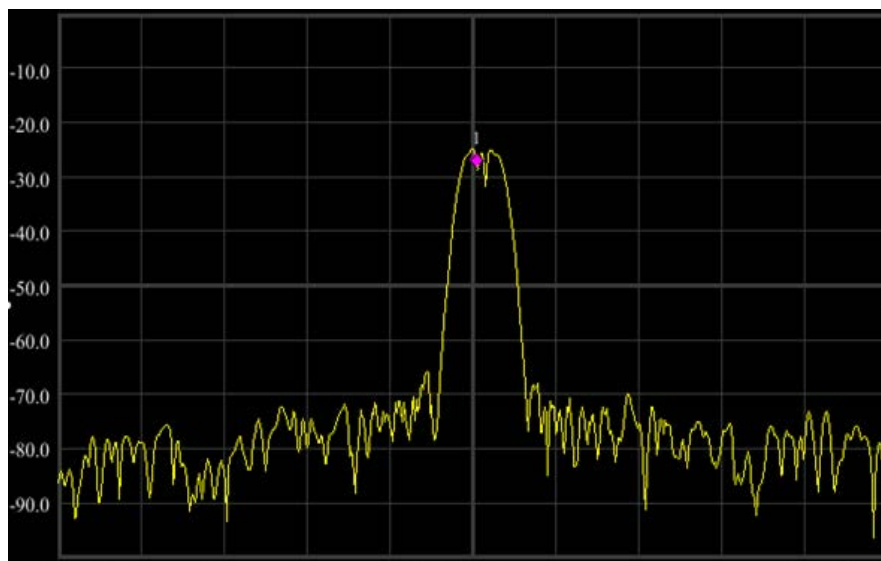

Fig 5-3: 1KHz RBW Trace

- 4) Optimize the test result. Lower the RBW to 100kHz.
 - Press **【BW】** , [Res BW Auto Man], input 100[Hz]

Then the 2 signals are clearly shown in screen as shown in figure below

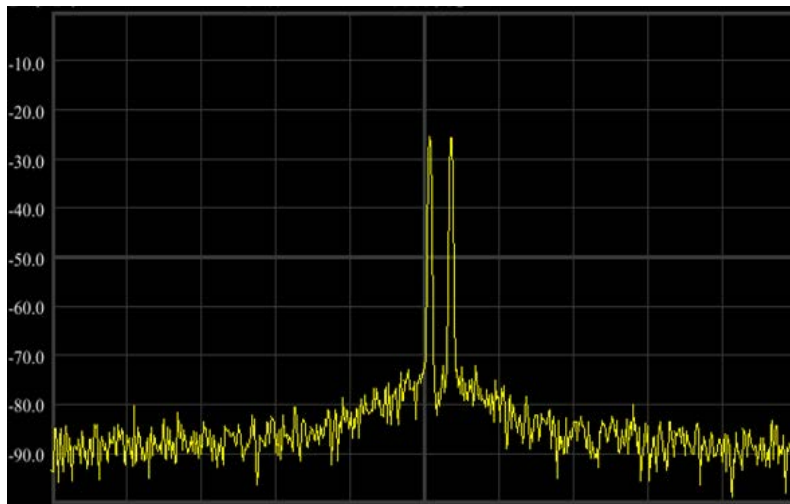

Fig 5-4: 100Hz RBW Trace

5.3.2 Resolving Signals of Different Amplitudes

To resolve two signals of different amplitudes, the resolution bandwidth must be equal to or less than the frequency interval of the two signals (same as resolving two signals of equal amplitude). But the maximum resolution bandwidth for resolving two signals with different amplitudes mainly depends on the squareness factor of IF filters other than the bandwidth 3dB.

Squareness factor is defined as the ratio of 60dB bandwidth to 3dB bandwidth of the intermediate frequency filter, as shown in Figure below.

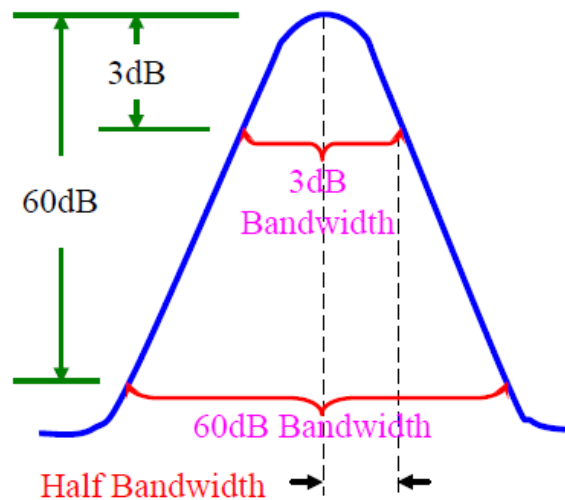

Figure 5-5 Schematic of Bandwidth and Squareness Factor

Example

Take resolving two signals of different amplitudes with frequency difference of 50 kHz and amplitude drop of 40dB as an example to explain the testing steps:

- 1) As shown in Figure 5-5, connect the outputs of two signal generators to the spectrum analyzer input.
- 2) Set the frequency of one signal generator to 1800MHz and amplitude to -10dBm. Set the frequency of the other signal generator to 1800.05MHz and signal output amplitude to -50dBm. Turn on the RF outputs of the two signal generators.

- 3) Set the spectrum analyzer to observe the signal:
 - Press **【Preset】** ;
 - Press **【Freq】** , [Center Freq], 1800.025[MHz].
 - Press **【Span】** , 500[kHz].
 - Press **【BW】** , [Res BW Auto Man], 30[kHz].

The squareness factor of the resolution bandwidth filter of S3531 Handheld Microwave Spectrum Analyzer is 5:1, when the resolution bandwidth is 30kHz, the bandwidth on 60dB point is 115kHz, the half bandwidth is 57.5kHz, which is wider than the frequency interval of 50kHz, so the two input signals cannot be resolved, as shown in Figure 4-6.

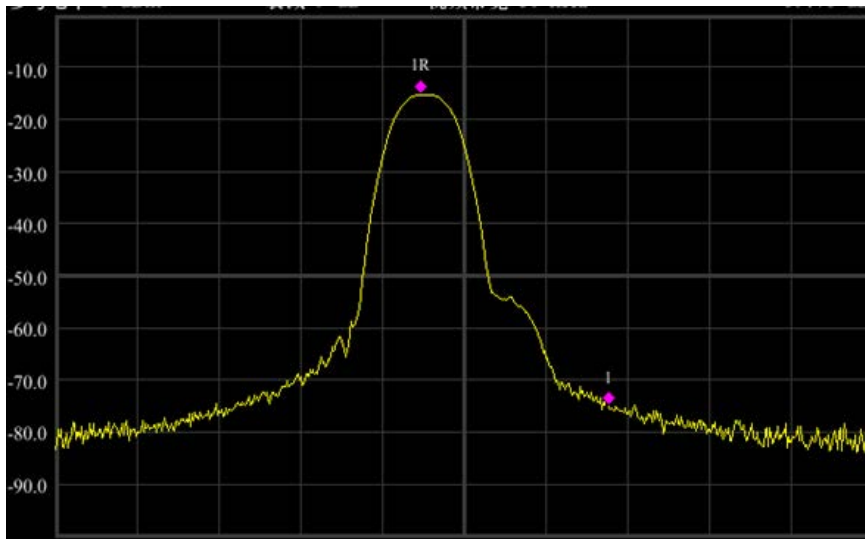

Figure 4-6: 30KHz RBW

- 4) Reduce the resolution bandwidth to view the small signals hidden.
 - Press **【BW】** , [Res BW Auto Man], 1[kHz].

At this moment, the half bandwidth is narrower than the frequency interval of 50 kHz, so the two input signals can be resolved. The two signals could be clearly seen on the screen.

- 5) Read the frequency difference and amplitude difference by the marker.
 - Press **【Peak】** and put the marker on the peak of the large signal;
 - Press **【Marker】** , [Delta], to enable the delta marker;
 - Press **【Peak】** , [Next Peak] to put the delta marker on the peak of small signal.

Now, the frequency difference and amplitude difference of the two signals with difference amplitudes can be read, as shown in following figure.

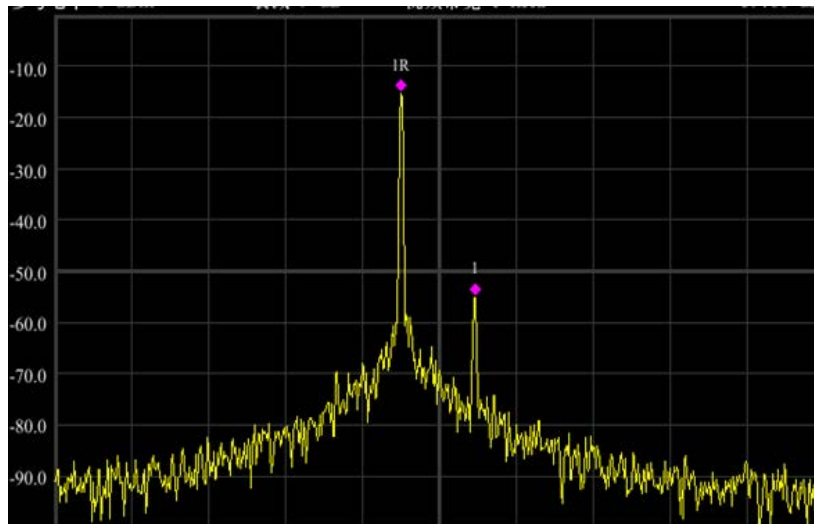

Figure 4-7: 1KHz RBW

5.4 N dB Bandwidth Measurement

Following example uses a S1103 signal generator and generates a 500MHz, -10dBm continuous signal.

Example

- 1) Connect the signal generator output port to S3531 RF test port.
- 2) Press **【Preset】** key to return the instrument to default status
- 3) Set test frequency.
 - Press **【FREQ】** key
 - Select [Center FREQ] and input 500MHz
 - Press **【SPAN】** key
 - Select [Span] and input 1MHz
- 4) Press **【BW】** key,
 - Select [Res BW Auto Man] and input 30kHz.

Now the signal trace is displayed on screen as shown in following figure.

- 5) Press **【Marker FUCT】**
- 6) Select [NdB On Off], turn on the NdB bandwidth measure function. The default value of NdB is 3dB. The value can be changed by selecting [NdB] and input the required value.
- 7) Read out the result

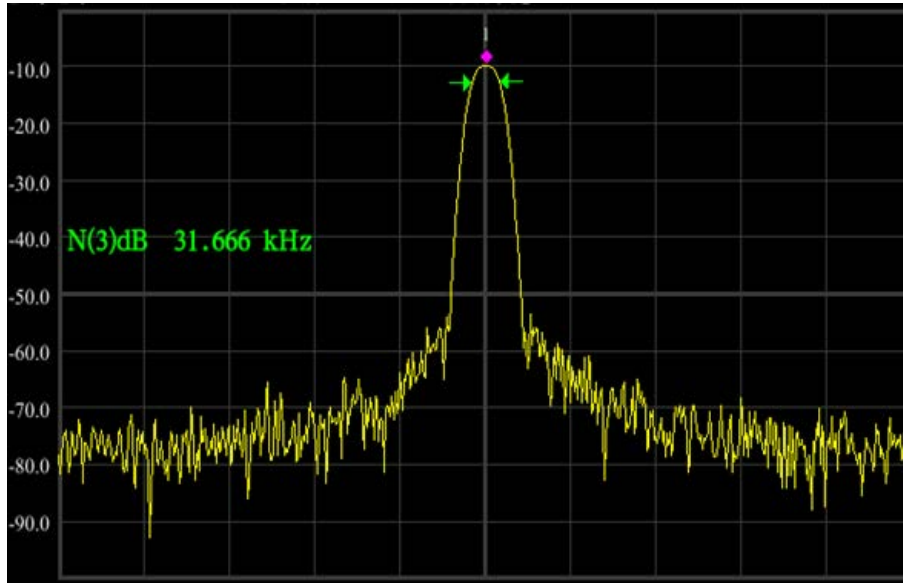

Figure 5-8: 3dB Bandwidth Test Result

5.5 Adjacent Channel Power

Following example uses a S1103 signal generator and generates a 500MHz, -10dBm continuous signal.

Example

- 1) Connect the signal generator output port to S3531 RF test port.
- 2) Press **【Preset】** key to return the instrument to default status
- 3) Set test frequency.
 - Press **【FREQ】** key
 - Select [Center FREQ] and input 500MHz

- 4) Press **【Meas】** key. Select [Adjacent Power]

The trace will be displayed as shown in the figure below.

- 5) Read out the result

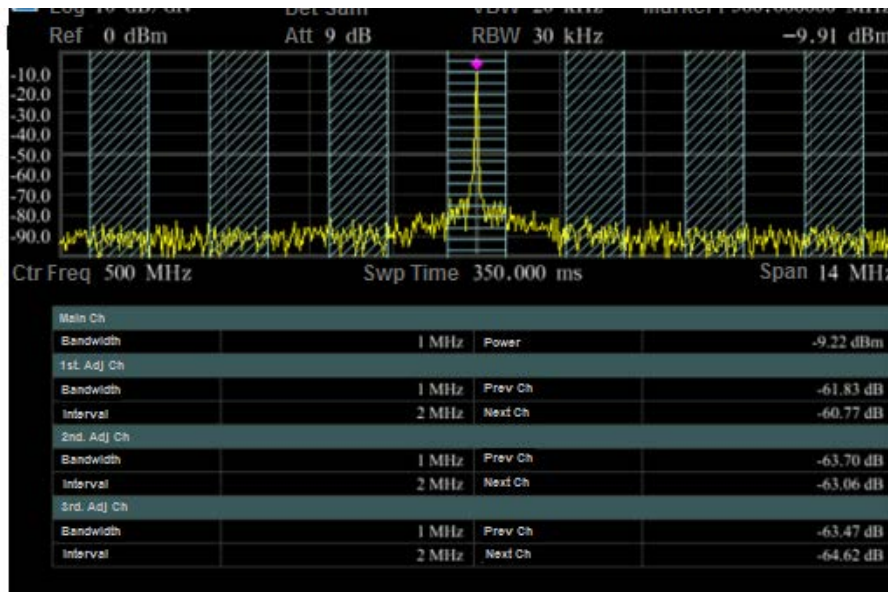

Figure 5-9: Adjacent Channel Measurement

5.6 Channel Power Measurement

Following example uses a S1103 signal generator and generates a 500MHz, -10dBm continuous signal.

Example

- 1) Connect the signal generator output port to S3531 RF test port.
- 2) Press **【Preset】** key to return the instrument to default status
- 3) Set test frequency.
 - Press **【FREQ】** key
 - Select [Center FREQ] and input 500MHz
- 4) Press **【Meas】** key. Select [Channel Power On Off], turn on the function
- 5) Select [Meas Settings], set the channel bandwidth to 1MHz

The trace will be displayed as shown in the figure below.

- 6) Read out the result

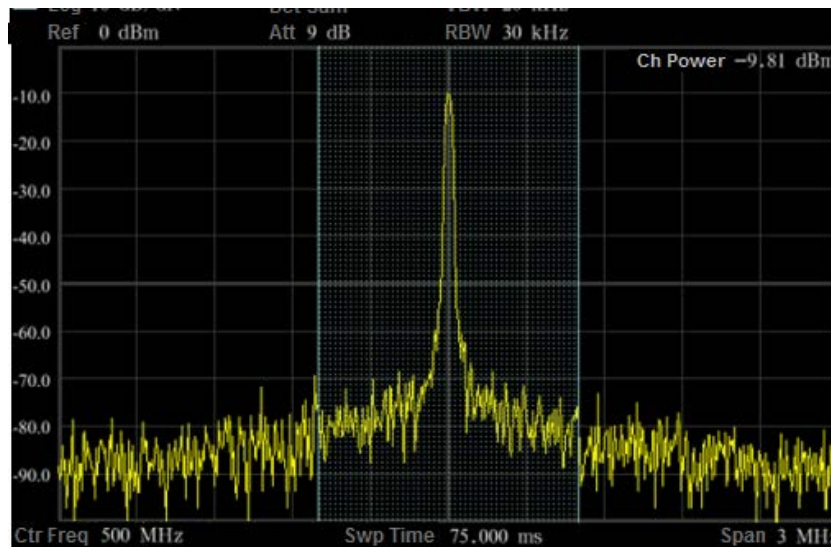

Figure 5-10: Channel Power Measurement

5.7 Occupied Bandwidth Measurement

Following example uses a S1103 signal generator and generates a 500MHz, -10dBm continuous signal.

Example

- 1) Connect the signal generator output port to S3531 RF test port.
- 2) Press **【Preset】** key to return the instrument to default status
- 3) Set test frequency.
 - Press **【FREQ】** key
 - Select [Center FREQ] and input 500MHz
- 4) Press **【Meas】** key. Select [Occupied BW On Off], turn on the function

The trace will be displayed as shown in the figure below.

- 5) Read out the result

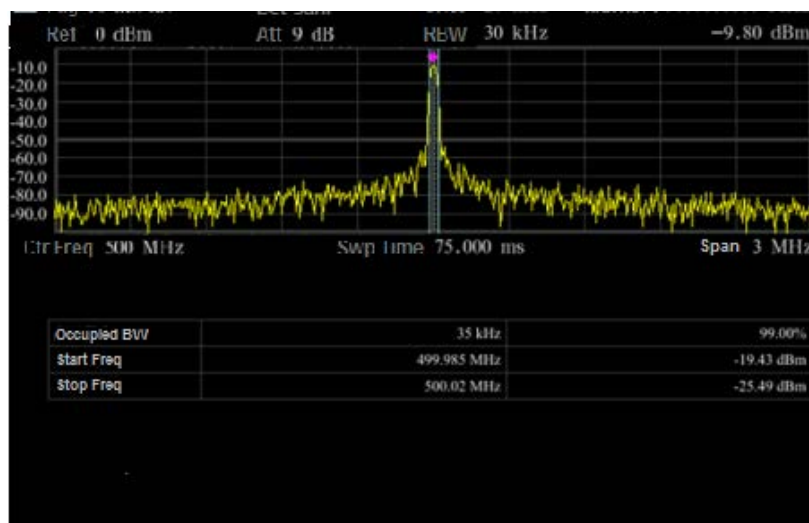

Figure 5-11: Occupied Bandwidth Measurement

5.8 Use Pre-amplifier to Capture Weak Signals

Following example uses a S1103 signal generator and generates a 500MHz, -80dBm continuous signal.

Example

- 1) Connect the signal generator output port to S3531 RF test port.
- 2) Press **【Preset】** key to return the instrument to default status
- 3) Set test frequency.
 - Press **【FREQ】** key
 - Select [Center FREQ] and input 500MHz
 - Press **【Span】** key
 - Select [Span] and input 10MHz
- 4) Enable the pre-amplifier
 - Press **【AMP】** key
 - Select [Ref level] and input -20dBm
 - Select [Pre Amp On Off], enable the pre-amplifier

The trace will be displayed as shown in the figure below.

- 5) Read out the result

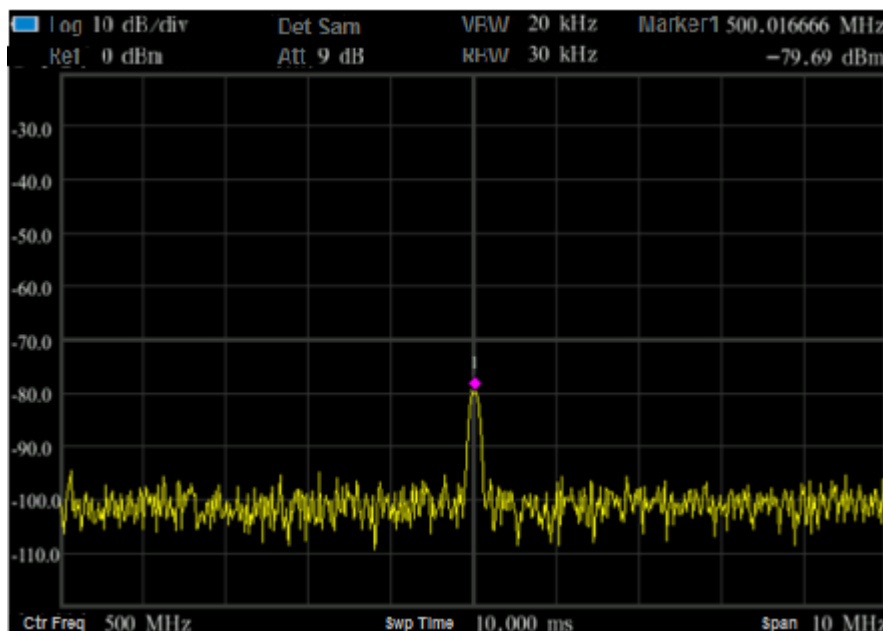

Figure 4-12: Pre-amplifier On Measurement

5.9 Harmonic Distortion Measurement

Following example uses a S1103 signal generator and generates a 300MHz, -10dBm continuous signal.

Example

- 1) Connect the signal generator output port to S3531 RF test port.
- 2) Press **【Preset】** key to return the instrument to default status
- 3) Set test frequency.
 - Press **【FREQ】** key
 - Select [Start FREQ] and input 200MHz
 - Select [Stop FREQ] and input 1GHz

The trace will be displayed as shown in the figure below. There are 3 peaks, signal, the second harmonic and the third harmonic.

- 4) Use **【Peak】** and **【Marker】** keys to do the analyze.
 - Press **【Peak】** key, S3531 will search the MAX value and mark it with a marker 1. In this example, the marker 1 is located at 300MHz and -10dBm signal which is the input signal.
 - Press **【Marker】** key
 - Select [Delta], a Marker 2 is activated and it is a Delta marker, the reference marker is Marker 1.
 - Press **【Peak】** key. Then Marker 2 will be located to the second harmonic. Read out the frequency and amplitude difference.
 - Press **【Peak】** key and select [Next Peak], then marker 2 will move to the third harmonic. Read out the frequency and amplitude difference.

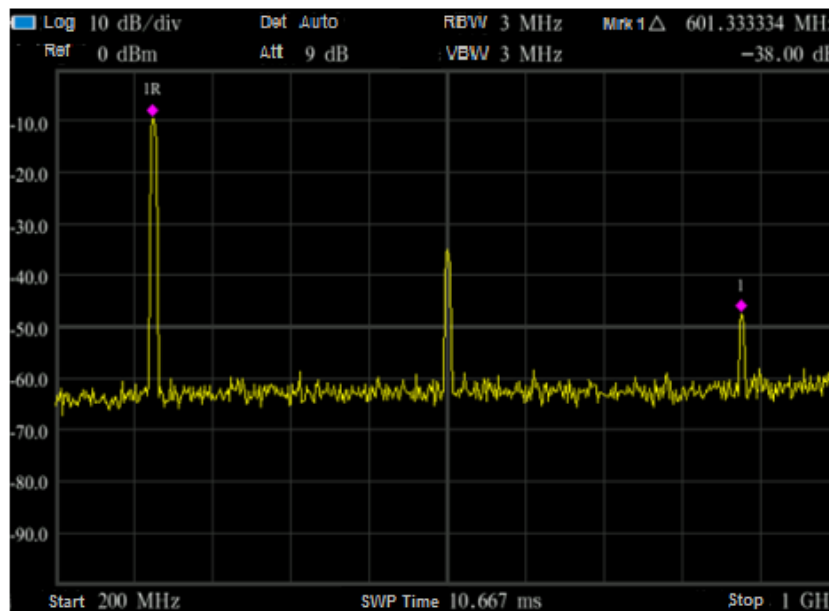

Fig5-13: Harmonic Distortion Measurement

5.10 TOI Distortion Measurement

In following example, use 2x signal generator to generate a 500MHz, -10dBm Sine signal and a 501MHz, -10dBm sine signal.

Example

- 1) Connect the outputs of two signal generators to the spectrum analyzer RF input port using a T-shaped connector, as shown

in Figure below.



Fig 5-14: TOI Distortion Measurement Connection

- 2) Press **【Preset】** key to return the instrument to default status
- 3) Set test frequency.
 - Press **【FREQ】** key
 - Select [Ctr FREQ] and input 500MHz
 - Press **【SPAN】** key
 - Select [SPAN] and input 5MHz
 - Press **【BW】** key
 - Select [Res BW Auto Man] and input 1kHz
- 4) Use **【Peak】** and **【Marker】** keys to do the analyze.
 - Press **【Peak】** key, S3531 will search the MAX value and mark it with a marker 1.
 - Press **【Marker】** key
 - Select [Delta], a Marker 2 is activated and it is a Delta marker, the reference marker is Marker 1.
 - Press **【Peak】** key. Select [Next Peak].
- 5) Readout the value of Marker 2. It is the TOI distortion

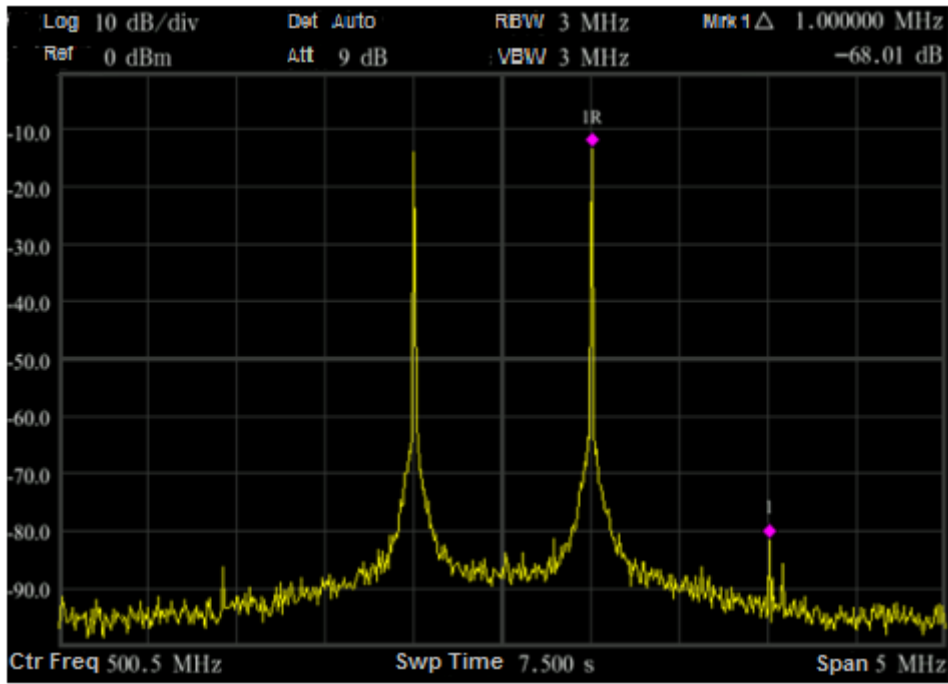

Fig 5-15: TOI Distortion Measurement

6 Menu Description

This chapter will provide a full function – menu mapping and will give description of each menu option.

6.1 Menu Structure

This section provides the structure of all buttons and soft-keys.

S3531 has following function keys on front panel. Following paragraphs will show the menu structure of these keys.



- AMPT
- BW
- DETECT
- DEMOD
- FILE
- FREQ
- MARKER
- MARKER→
- MARKER FCTN
- MEAS
- PEAK
- PRINT
- SAVE
- SOURCE
- SPAN
- SWEEP

- SYSTEM
- TRACE
- TRIG

In following paragraphs, F1-F6 are corresponding keys to operate the menu shown in the screen. Different menu levels will be shown in different colors.



6.2 AMPT

Pop up menus related to parameter setting of Amplitude, including [Reference Level], [Attenuator▶], [Preamplifier ON OFF], [Scale Type Logarithm Linear], [Scale/Division], [Ref Unit], [Ref Offset]. Please refer to following diagram for the menu structure.

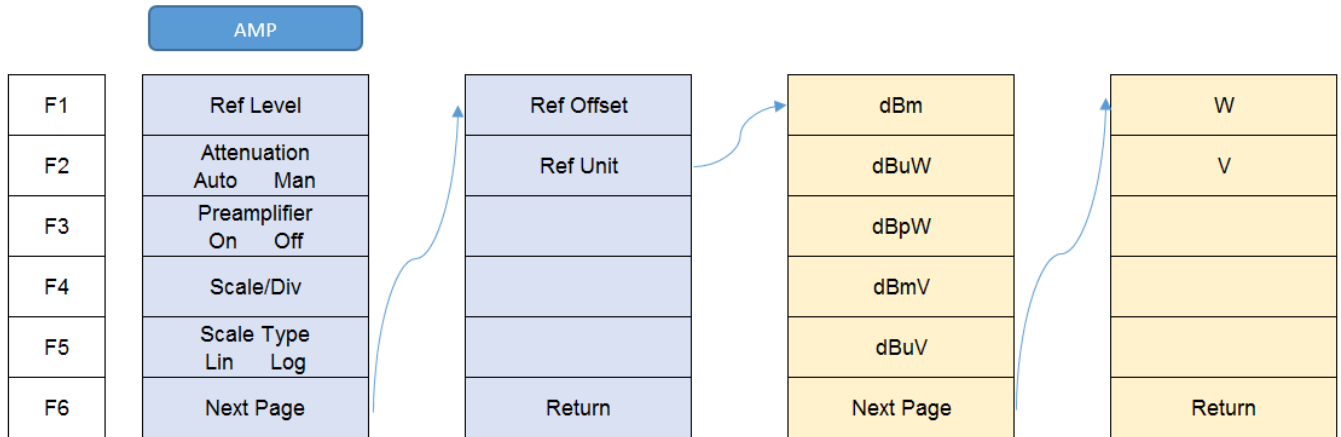

- **Ref Level**

Menu description: The reference level can be adjusted with the number keys, step keys or knob. The reference level corresponds to the top of the coordinate top. Measure signal at reference level position to get highest accuracy. The input attenuator of the signal/spectrum analyzer is coupled to the reference level, which can be automatically changed to avoid compression of input signal.

- **[Attenuator Auto Man]**

Menu description: In the manual mode, set attenuator to lower the distortion of large signal. Maximum can be set to 39dB

- **[Preamplifier ON OFF]**

Menu description: to control the ON OFF status of the preamplifier. Preamplifier is provided as a standard component.

- **[Scale/Div]**

Menu description: to select the scale/division 1, 2, 4, 10dB/division. This menu is only valid when the scale type is logarithm.

- **[Scale type Log Lin]**

Menu description: to select the Y Axis Scale Type as Logarithm or Linear. In general, the logarithm scale unit is dBm and the linear scale unit is mV. Other unit types will be manually selected through the [Ref Unit].

- **[Ref Unit]**

Menu description: to select the Ref unit from [dBm], [dBuW], [dBpW], [dBmV], [dBuB], [W], [V]. The instrument will automatically calculate the trace data and marker readout based on the Y axis scale unit.

- **[Ref Offset]**

Menu description: to introduce offset for all amplitude readout (e.g., reference level and marker amplitude). It will not change the trace position on the screen. This offset unit is dB and is not affected by the scale and unit. Use number keys, stepping keys or knob to input the offset value.

6.3 BW

Pop up the soft menus for setting of resolution bandwidth , video bandwidth, including [RBW Auto Manual], [RBW Mode Def Count], [VBW Auto Manual], [Average], [EMI BW]

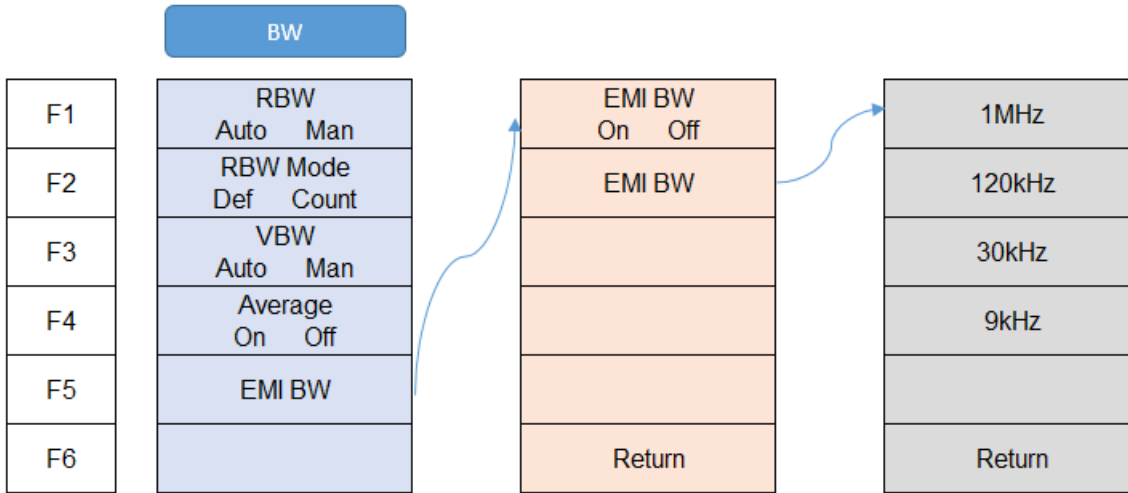

- [RBW Auto Manual]

Menu description: to change the resolution bandwidth of spectrum analysis, ranging from 1Hz to 3MHz, which is stepped by 1, 3, 5. The resolution bandwidth can be changed with the number keys, step keys and knob. The shaded character indicates the currently selected mode.

- [RBW Mode Def Count]

Menu description: Manually change the RBW by step or continuously.

- [VBW Auto Manual]

Menu description: to change the video bandwidth within the active function area, ranging from 10Hz to 20MHz, which is stepped by 1, 3, 5. Use number keys, stepping keys or knob to change The current mode is shaded.

- [Average]

Menu description: to smooth the trace based on the average factor N.

- [EMI BW]

Menu description: to enable/disable EMI BW function. When [EMI BW] is enabled, user can select EMI bandwidth from 1MHz, 120kHz, 30kHz, 9kHz

6.4 Detect

Pop up soft menus related to setting the detector type for the currently selected trace, including [Auto], [Normal], [Pos Peak], [Sample], [Neg Peak].

Detect	
F1	Auto
F2	Normal
F3	Pos Peak
F4	Neg Peak
F5	Sample
F6	

- [Auto]

Menu description: to set the detector command for the currently selected trace as Auto. That means, the signal/spectrum analyzer will automatically select most suitable detector based on the parameter setting of currently selected trace, including trace processing method, trace average type, noise marker function, etc.

- [Normal]

Menu description: to set the detector command for the currently selected trace as Normal. i.e., display the measurement results of positive peak and negative peak at the same time to achieve display effect similar to the analog instrument.

- [Positive Peak]

Menu description: to set the detector command for the currently selected trace as Positive Peak. i.e., take the maximum value from sampling data assigned to each trace point.

- [Sample]

Menu description: to set the detector command for the currently selected trace as Sample. i.e., take the last value from sampling data assigned to each trace point.

- [Negative Peak]

Menu description: to set the detector command for the currently selected trace as Negative Peak. i.e., take the minimum value from sampling data assigned to each trace point.

6.5 Demod

Menu Description: Audio analysis function. Support audio signal input from [FMW], [FM], [AM], [USB], [LSB], user can hear the audio output via the load speaker or a earphone.

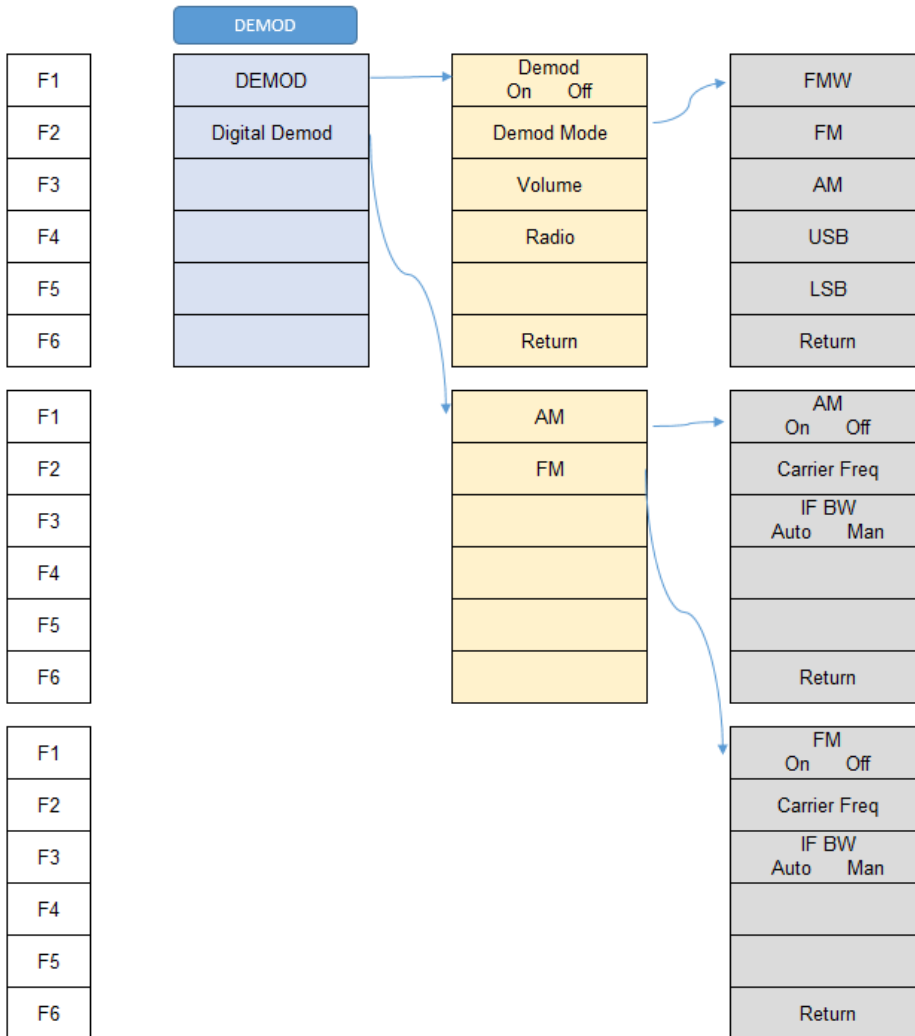

- [Demod On Off]

Menu Description: Turn On Off Audio analysis function

- [Demod Mode]

Menu Description: Select the audio input

- [Volume]

Menu Description: Set the volume of load speaker/earphone

- [Radio]

Menu Description: Preset Radio frequencies.

- [Digital DEMOD]

Menu Description: Analog demodulation functions. FM/AM are supported

6.6 FILE

Pop up the soft menus for file operations. User can view, sort, export, delete, recall the saved files.

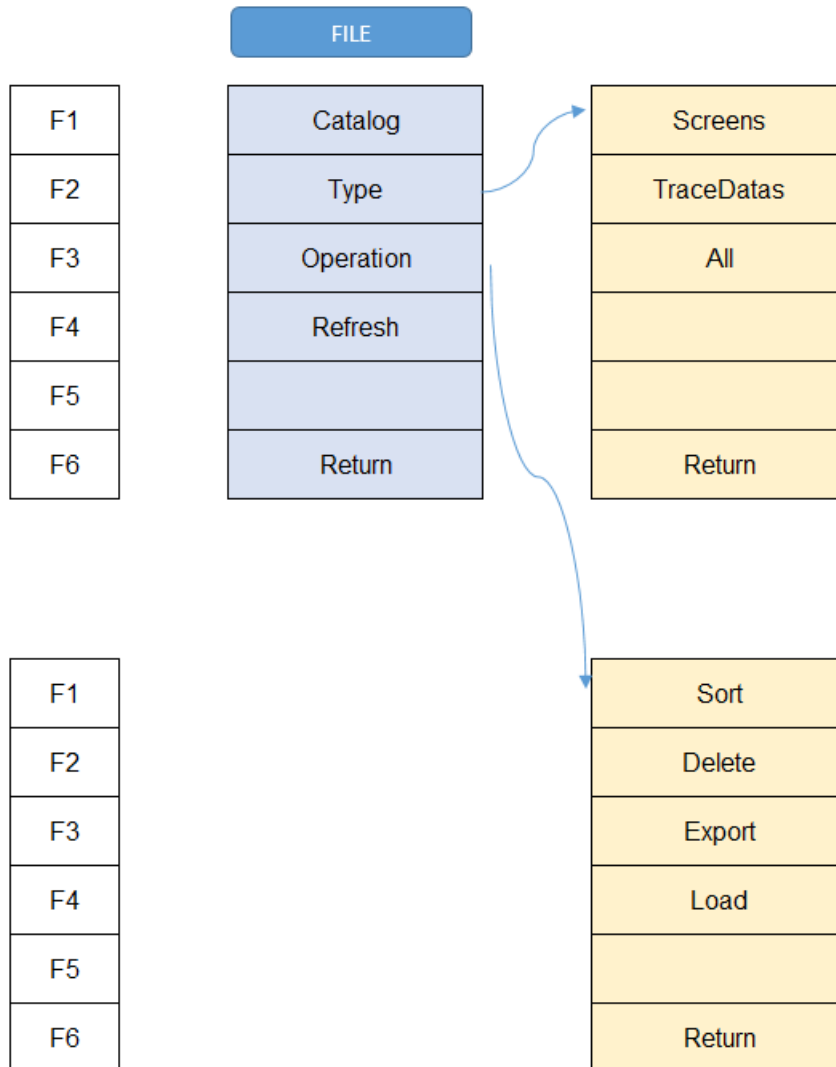

- [Catalog]

Menu description: View all saved screenshot or datafiles. [First Page], [Prev Page], [Next Page], [Last Page] buttons are provided.

- [Type]

Menu description: View files in different types. Following types are provided [Screens], [TraceDatas], [All].

- [Operation]

Menu description: User can sort all files for easy view. Delete file, Export file to USB and recall a file also provided in the submenu.

6.7 FREQ

The [Frequency] key on the front panel is used to set parameters related to the signal/spectrum analyzer frequency, including [Center Frequency], [Start Frequency], [Stop Frequency], [CF Step Auto ON OFF], [Frequency Offset]. User can configure the frequency measurement scope through the [Start Frequency] and [Stop Frequency], or through the [Center Frequency] and [Span]. Press the [Frequency] key to enable any soft menu from [Center Frequency], [Start Frequency] and [Stop Frequency], and corresponding parameter input area will display current parameters.

Following diagram gives a direct view of the menu structure

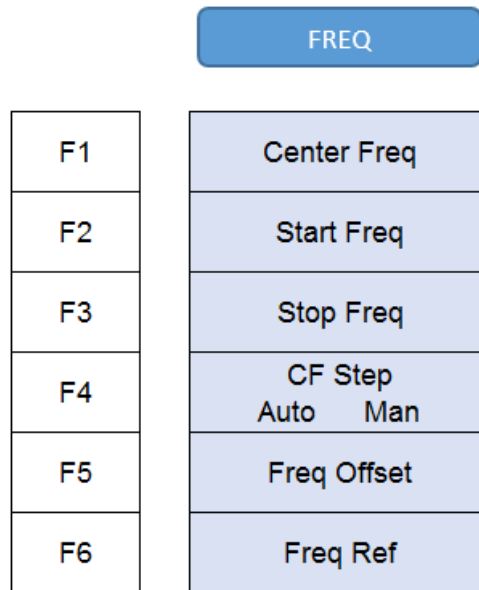

- [Center Freq]

Menu description: to enable the center frequency and set the signal/spectrum analyzer into the center frequency/span mode. Use number keys, stepping keys or knob to change the center frequency. If the set center frequency is inconsistent with the current span, the settings will automatically adjusted to the value best suitable for desired frequency

- [Start Freq]

Menu description: to enable the start frequency and set the signal/spectrum analyzer into the start frequency/stop frequency mode. Use number keys, stepping keys or knob to change the start frequency. In changing the start frequency, if the selected start frequency is larger than the stop frequency, the latter one will automatically increase till equaling to the sum of start frequency plus minimum span

- [Stop Freq]

Menu description: to enable the stop frequency and set the signal/spectrum analyzer into the start frequency/stop frequency mode. Use number keys, stepping keys or knob to change the stop frequency. In changing stop frequency, if the selected stop frequency is less than the start frequency, the latter one will automatically decrease till equaling to the difference of stop frequency minus minimum span.

- [CF Step Auto Manual]

Menu description: to change the steps of center frequency, start frequency or stop frequency. When the center frequency is active, press the step key, the frequency step changes 1/10 of the span. When it is under Manual mode, use the number keys, stepping keys or knob for change. At this time, reactivate the [Center Frequency], and press the step key, the center frequency

will change by setting step. This function is very useful to quickly change the center frequency to the input signal harmonic. For example, observe the harmonic of 300MHz input signal, and set the [CF Step Auto Manual] as Manual, and input 300MHz. If the current center frequency is 300MHz, press the stepping key to increase the center frequency to 600MHz. Press the stepping key again to increase the center frequency by 300MHz to 900MHz. The shaded status of [CF Step Auto Manual] menu indicates whether the step is set as Auto or Manual. When the step is under Manual, select the Auto from [CF Step Auto Manual] to return to Auto status.

- [Frequency Offset]

Menu description: to add the set frequency offset to the displayed frequency value, including marker frequency value, but this does not affect the sweep span. Use number keys, stepping keys or knob to change the offset.

- [Frequency Ref]

Menu description: to switch between internal reference signal and external reference signal. When use external reference, need to connect a 10MHz reference source to the Ext Ref port.

6.8 Marker

Pop up the soft menu related to markers, including [Marker 1 2 3 4 5], [Trace 1 2 3 4 5], [Delta], [Normal], [OFF], [All off], [Marker Table ON/OFF].

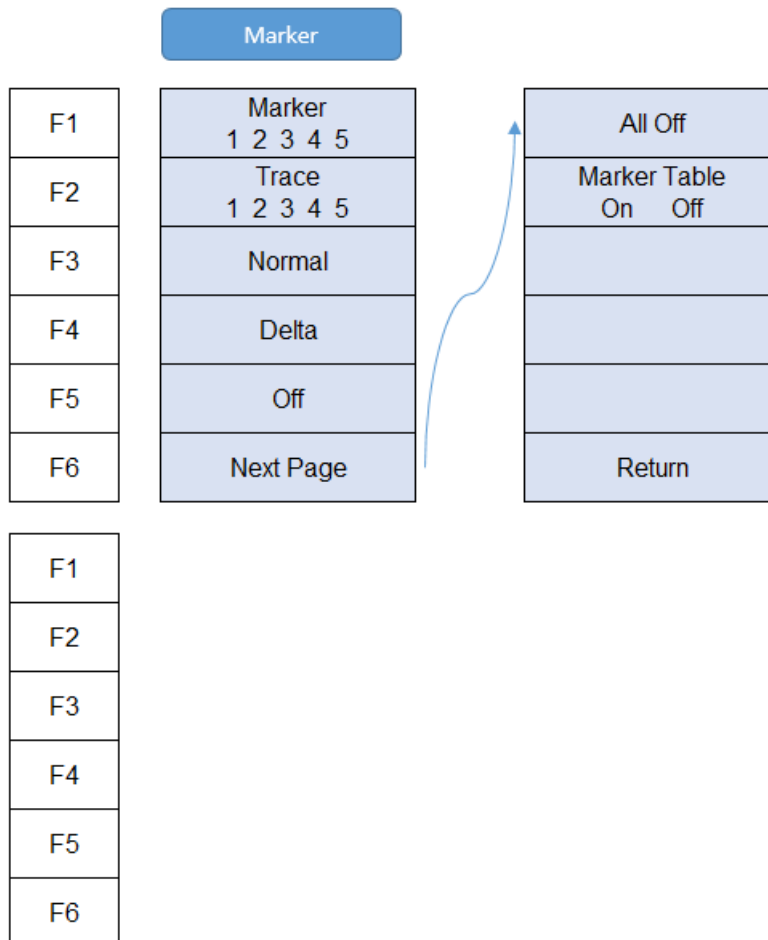

- **[Marker 1 2 3 4 5]**

Menu description: S3531 supports 5 markers simultaneously. Only one is activated. [Marker 1 2 3 4 5] is used to select the activated marker. If the selected marker is not created, user can use [Normal] or [Delta] to create and activate the marker.

- **[Trace 1 2 3 4 5]**

Menu description: Move the selected marker to other traces.

- **[Normal]**

Menu description: Create a new normal maker, or change the active marker from a delta marker to a normal marker. Normal marker will information is displayed on screen (X axis value, Y axis value)

- **[Delta]**

Menu description: Create new reference marker/delta marker, or add a reference marker to the active normal marker. The reference marker will be set at the same X-axis value of the delta maker. If user want to move the reference marker, first move the delta marker to the wanted place then press [Delta] again, then the reference marker will move to the same position. Delta marker information will be display on screen (X axis, Y axis value difference between reference marker and delta marker).

- [Off]

Menu description: Turn off the selected marker.

- [All Off]

Menu description: Turn off all markers.

- [Marker Table On Off]

Menu description: to turn on/off the marker table display. Where there are many markers, it is convenient for data measurement.

6.9 Marker->

Pop up soft menus related to Marker->Function. Such menus are related to the frequency, span and marker type

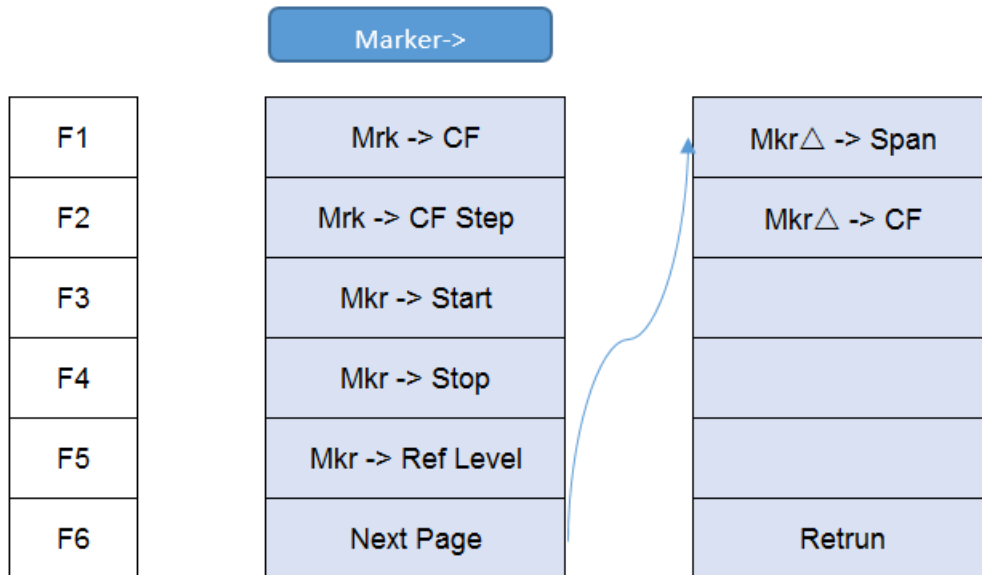

- **[Marker → CF]**

Menu description: to set the Center Frequency equal to the Marker Frequency. It can quickly move the signal to the center position of the screen.

- **[Marker → CF Step]**

Menu description: to set the Frequency Step equal to the Marker Frequency. The menu changes the value of frequency step.

- **[Marker → Start]**

Menu description: to set the Start Frequency equal to the Marker Frequency. The menu changes the value of start frequency.

- **[Marker → Stop]**

Menu description: to set the Stop Frequency equal to the Marker Frequency. The menu changes the value of stop frequency.

- **[Marker → Reference Level]**

Menu description: to set the Reference Level equal to the Marker Amplitude. The menu changes the value of reference level.

- **[Delta Marker → Span]**

Menu description: to set the Span equaling to frequency difference of the Delta Marker. The menu changes the value of frequency span.

- **[Delta Marker → CF]**

Menu description: to set the Center Frequency equal to frequency difference of the Delta Marker. The menu changes the value of center frequency.

6.10 [Marker Function]

The [Marker Function] key is used for turning on the control instrument marker functions. The Marker Function performs post-processing on the marker data. Its soft menu includes [Marker Noise ON/OFF], [NdB ON/OFF], [Freq Count]

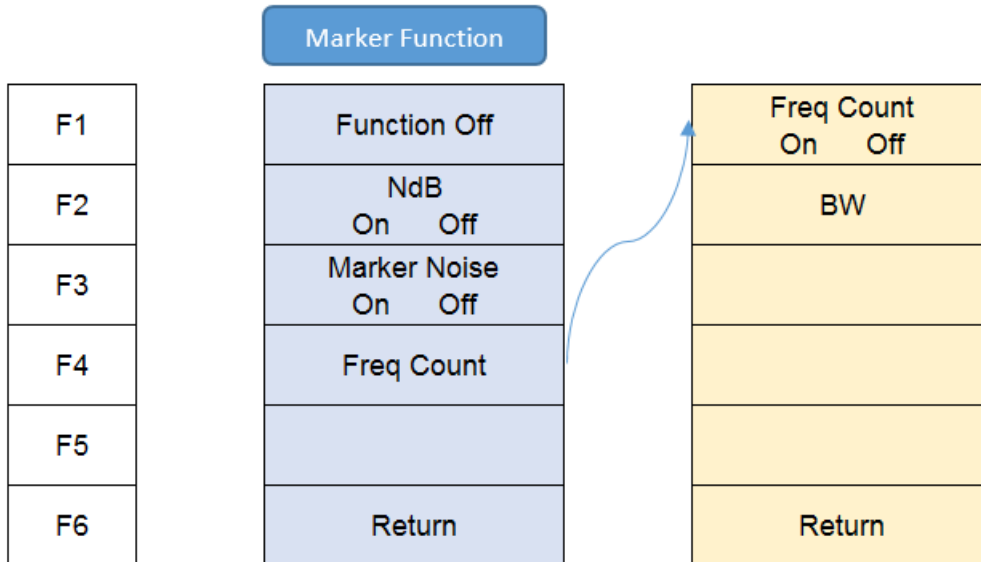

- [Marker Noise On Off]

Menu description: when this menu is ON, it activates the noise maker. Read out the noise power that normalizes the noise into 1Hz bandwidth near the active marker. At that time, the detector is under Sample Detector mode.

- [Freq Count]

Menu description: to turn on or off marker Freq Count. If there is no active marker, enabling this function will activate an active marker at the center of screen. The Marker Count readout is not affected by the Frequency Offset. To facilitate normal function of Freq Count, the SPAN/RBW should be less than 500.

- [NdB ON/OFF]

Menu description: to turn on or off the NdB measurement of bandwidth values descending from signal peak point. You can input the NdB value to be measured from the front panel.

6.11 Meas

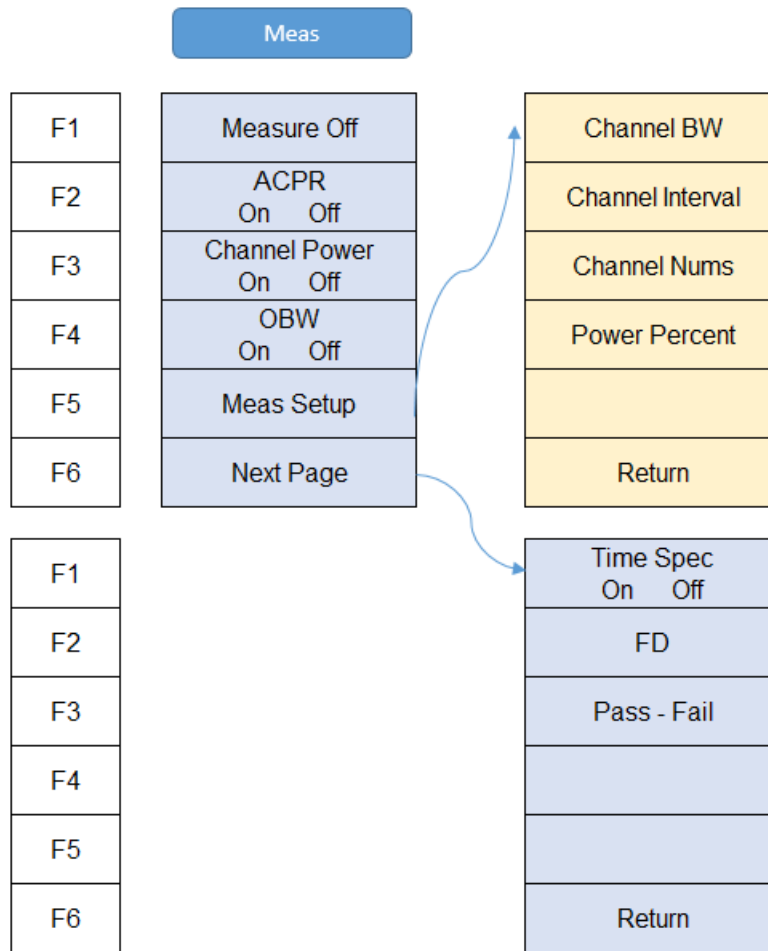

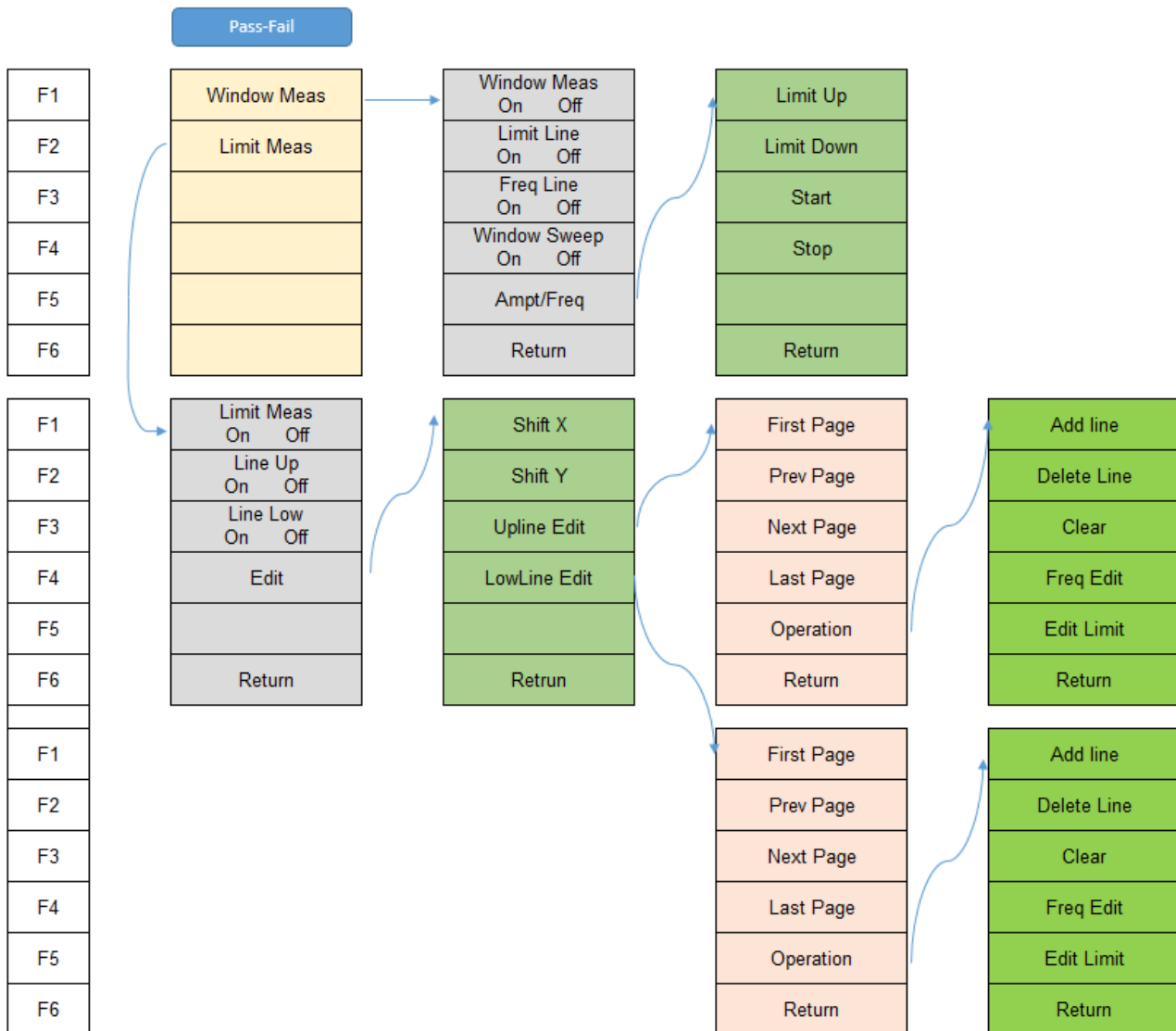

- [Measure Off]

Menu description: Turn off current measurement functions.

- [ACPR]

Menu description: Turn on adjacent channel power rate measurement function. Detailed settings to be done in [Meas Setup]. ACPR is used to measure the power rate between the adjacent channel and the main channel.

- [Channel Power]

Menu description: Turn on channel power measurement function. Detailed settings to be done in [Meas Setup]. The channel power is measured based on the channel bandwidth settings.

- [OBW]

Menu description: Turn on occupied bandwidth measurement function. Detailed settings to be done in [Meas Setup]. User can set the power percent in [Meas Setup] to calculate the occupied bandwidth.

- [Meas Setup]

Menu description: Settings for measurement functions. These settings are channel bandwidth, channel interval, channel qty and power percent.

- [Time Spec]

Menu description: This function will provide a waterfall diagram to show the possibility of a signal. It is very helpful to do interference analysis.

- [Pass-Fail]

Menu Description: S3531 provide a powerful Pass-fail function with [Window Meas] and [Limit Meas]

- [Window Meas]

Menu Description: [Window meas] will provide 4 limit lines (2 vertical, 2 horizontal) and create a [Pass- Fail] window.

- ◆ [Window Meas On Off]

Menu Description: Turn on/off the window meas function

- ◆ [Limit Line On Off]

Menu Description: Turn on/off the horizontal limit lines (for amplitude)

- ◆ [Freq Line On Off]

Menu Description: Turn on/off the vertical limit lines (for frequency)

- ◆ [Window Sweep On Off]

Menu Description: If turn on window sweep, only the trace in the limit window is free-run, trace outside the window is hold.

- ◆ [Ampt/Freq]

Menu Description: Adjust the limit line position

- [Limit Meas]

Menu Description: Limit Meas provides 2 lines to set limit on amplitude. User can add or delete point on each line to make it to a user-defined mask.

- ◆ [Limit Meas On Off]

Menu Description: Turn on/off the limit meas function

- ◆ [Line Up On Off]

Menu Description: Turn on/off the upper line

- ◆ [Line Low On Off]

Menu Description: Turn on/off the lower line

- ◆ [Edit]

Menu Description: User can add/delete/move any point of the limit line to make it a user-defined mask.

6.12 PEAK

The [Peak] key on the front panel. is used to turn on the peak search for traces by the control instrument and turn on marker for display, including [Next Peak], [Right Peak], [Left Peak], [Marker->CF], [Continuous Max ON OFF], [Min Search].

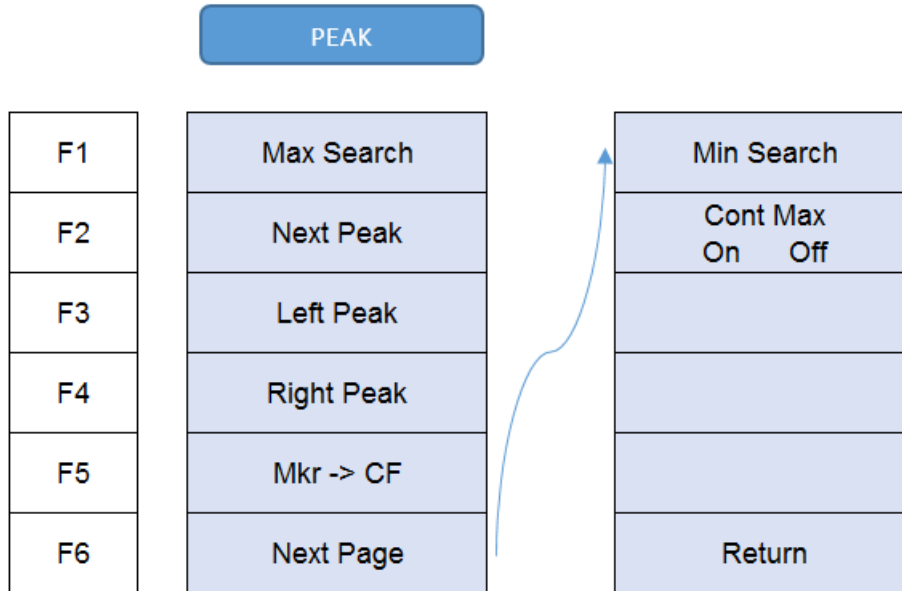

- [Next Peak]

Menu description: Taking the Amplitude of the point where the current marker is located, search for the next peak of current test trace.

- [Right Peak]

Menu description: to search for the peak to the right of the current test trace marker position.

- [Left Peak]

Menu description: to search for the peak to the left of the current test trace marker position.

- [Marker → CF]

Menu description: to set the Center Frequency equal to the Marker Frequency. It can quickly move the signal to the center position of the screen.

- [Continuous Max On Off]

Menu description: when Continuous Max is ON, the current marker will perform one Peak Search after each sweep. If the Continuous Peak Search is OFF, no operation is made.

- [Min Search]

Menu description: to turn on the Min Search.

6.13 Print

Pop up the printing settings, user can select the paper size, the paper orientation etc.

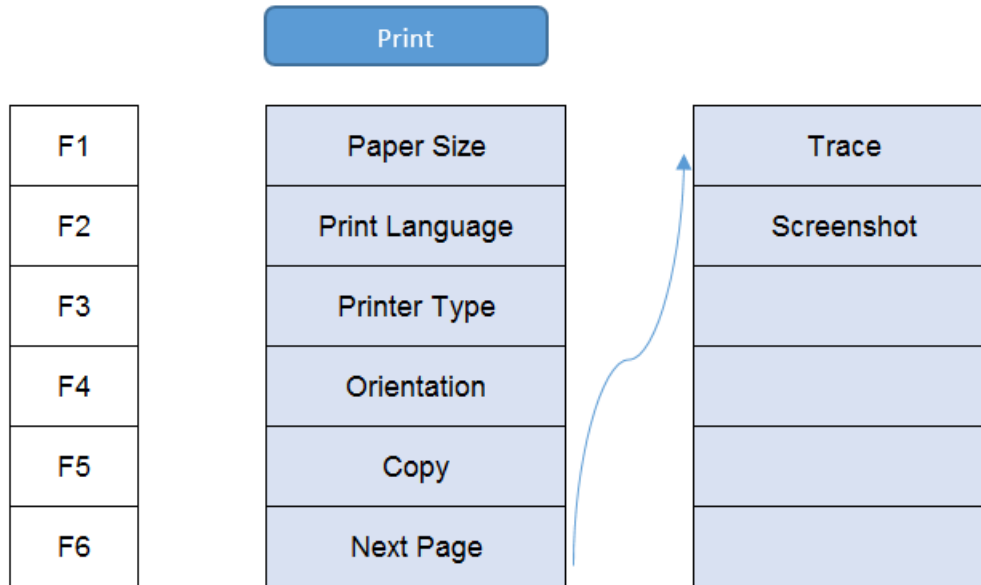

6.14 SAVE

Save function can help user to save measurement data like screenshot or trace data. Meanwhile it can also save the state file and settings. It is very helpful for data analysis and repeat tests.

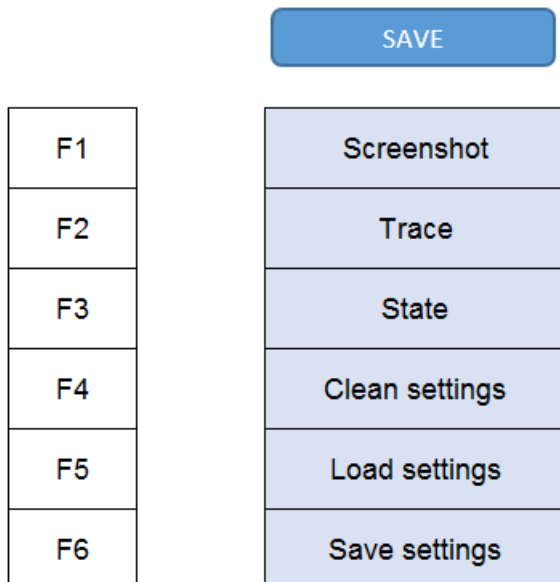

6.15 SOURCE

Source key will activate the source menu, user can set build-in signal generator and the tracking generator.

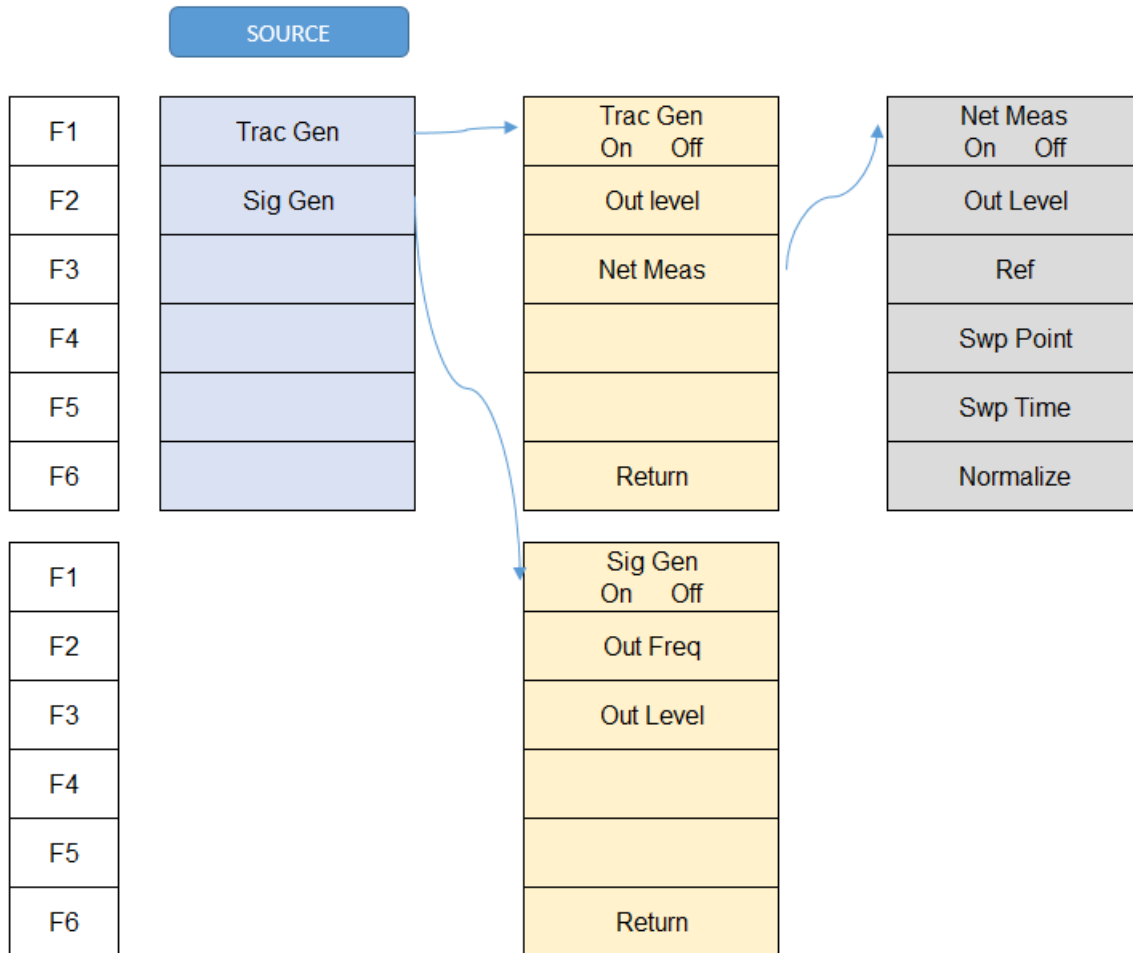

- [Trac Gen]

Pop out the submenu for tracking generator

- [Trac Gen On Off]

Menu description: to turn on/off the tracking generator.

- [Out Level]

Menu description: to set the output power level of tracking generator.

- [Net Meas]

Menu description: Pop out the submenu for network measurement

- ◆ [Net Meas On Off]

Menu description: To turn on/off the network measurement function.

- ◆ [Out Level]

Menu description: To set the output power level.

- ◆ [Ref]

Menu description: To set the reference.

◆ [Swp Point]/[Swp Time]

Menu description: Set the sweep point and sweep time

◆ [Normalize]

Menu description: To normalize the test result.

● [Sig Gen]

Pop out the submenu for signal generator settings

■ [Sig Gen On Off]

Menu description: to turn on/off the build-in signal generator.

■ [Out Level]

Menu description: to set the output power level of signal generator.

■ [Out Freq]

Menu description: to set the output frequency of signal generator.

6.16 Span

Press the [Span/X Axis] on the front panel to enable the span function and set the signal/spectrum analyzer into center frequency/span mode. Press the [Span] key to pop up [Span], [Full Span], [Zero Span] and [Previous Span] at the same time.

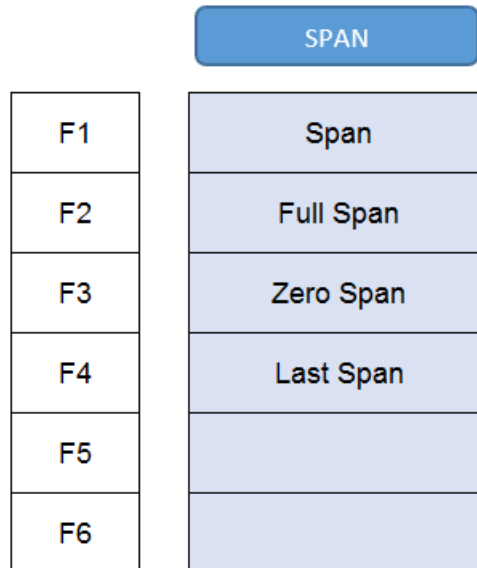

- **[Span]**

Menu description: the span can be set by number keys, stepping keys or knob. Use number keys or select [Zero Span] to set the span as zero.

- **[Full Span]**

Menu description: to set the signal/spectrum analyzer into the center frequency/span mode. Set the span as maximum value.

- **[Zero Span]**

Menu description: to set span as 0Hz. It is good for observing signal at time domain, in particular, good for observation of modulating signal.

- **[Last Span]**

Menu description: to set the signal/spectrum analyzer back to the previous span.

6.17 Sweep

Pop up the soft menus for setting of sweep, including [Sweep Time], [Sweep Point], [Sweep Single], [Sweep Count]

SWP	
F1	Sweep Time Auto Man
F2	Sweep Single
F3	Sweep Cont
F4	
F5	
F6	Sweep Point

- [Sweep time Auto Manual]

Menu description: to change the sweep time of signal/spectrum analyzer by number keys, stepping keys or knob. When it is under Manual mode, it indicates that sweep time can be set manually. When it is under Auto mode, the sweep time will be automatically coupled based on resolution bandwidth, span and video bandwidth

The sweep time is coupled with the sweep type, resolution bandwidth, video bandwidth, average function and span. Changing those parameters will result in change of the sweep time or triggering of the limit setting of sweep time.

- [Sweep Continuous] / [Sweep Single]

Menu description: to set continuous sweep or single sweep. Continuous sweep is the default measurement control method; when enable [Sweep Single], sweep will be done only one time.

6.18 System

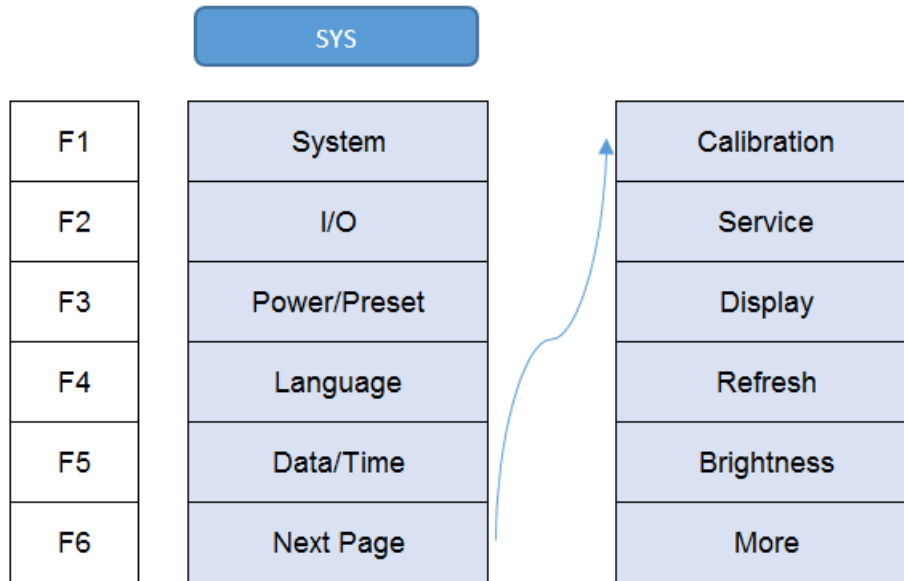

- [System]

Menu description: To check system information and system log. Including serial number, device type, hardware version, network settings, power supply etc.

- [I/O]

Menu description: To configure the LAN port and the serial port, like IP address etc.

- [PowerOn/Preset]

Menu description: To customize the preset configuration

- [Language]

Menu description: To change the language.

- [Date/Time]

Menu description: To change the time settings

- [Calibration]

Menu description: Calibrated the instrument

- [Service]

Menu description: This function is not open for end user.

- [Display]

Menu description: Display settings, include full window display, zoom settings, grim settings etc

- [Brightness]

Menu description: Set the screen brightness

6.19 Trace

Press [Trace] key on the front panel to pop up corresponding soft menu. Including: [Trace 1 2 3 4 5], [Clear Write], [Max. Hold], [Min. Hold], [Blank], [View], [Detector], [Operation].

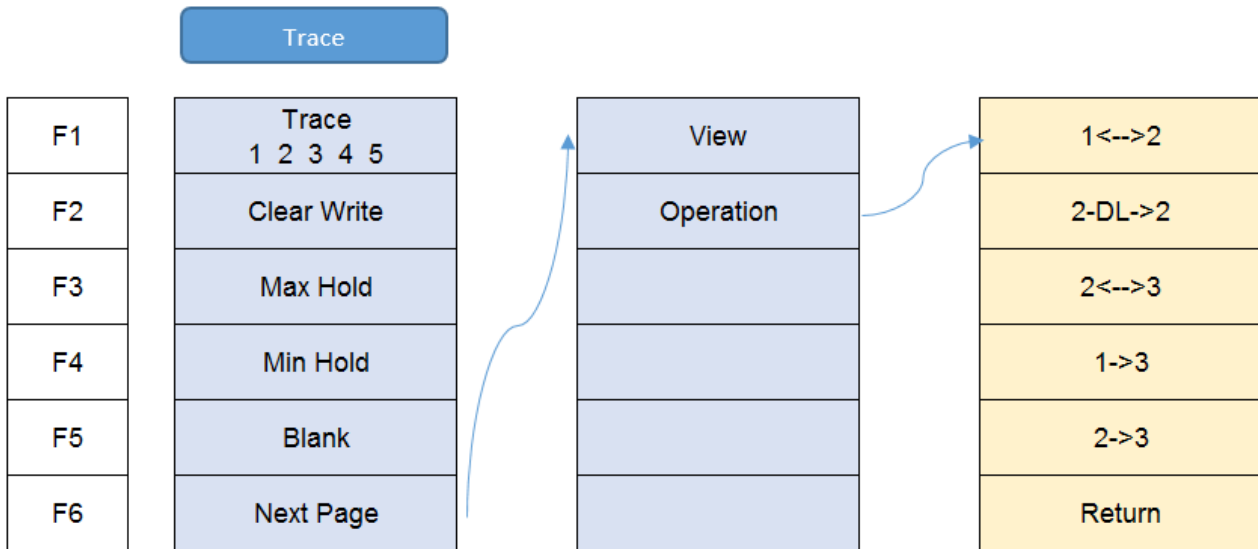

- [Trace 1 2 3 4 5]

Menu description: to select trace. The signal/spectrum analyzer provides 5 trace lines Trace 1, Trace 2, Trace 3, Trace 4, Trace 5.

- [Clear Write]

Menu description: to set the current trace processing as Clear Write, i.e., clear all data of displayed trace and continue the signal trace receipt under sweep status.

- [Max. Hold]

Menu description: to set the current trace processing method as maximum hold, i.e., the new trace data will be assigned with maximum value of previous measured trace data.

- [Min. Hold]

Menu description: to set the current trace processing method as minimum hold, i.e., the new trace data will be assigned with minimum value of previous measured trace data.

- [Blank]

Menu description: Clear all displayed traces. Trace save in register will not be deleted.

- [View]

Menu description: Hold current trace and not refresh. Easy for checking.

- [Trace Operation]

Menu description: to start up trace mathematical operation and set the methods and rules. The soft menus include [1<-->2], [2-DL->2], [2<-->3], [1->3], [2->3].

- [1<-->2]

Menu description: Exchange the data in trace register 1 and trace register 2 and display

■ [2-DL->2]

Menu description: Data in trace register 2 minus current trace and save the result in trace register 2 and display.

■ [2<-->3]

Menu description: Exchange the data in trace register 2 and trace register 3 and display

■ [1->3]

Menu description: Put data in trace register 1 into trace register 3 and display.

■ [2->3]

Menu description: Put data in trace register 2 into trace register 3 and display.

6.20 Trig

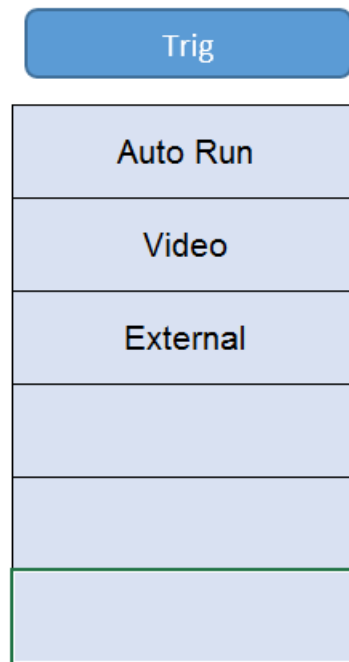

Menu Description: Set the trigger mode. S3531 supports both internal and external trigger.

- [Auto Run]

Menu Description: Free run

- [Video]

Menu Description: Set the trigger mode to Video trigger

- [External]

Menu Description: Tigger signal from external trigger source. [POS] rising edge and [NEG] falling edge are supported.

7 Remote Control

User can program the S3531 via the standard SCPI (Standard Commands for Programmable Instruments) command. For a detailed description of the commands and programming, refer to Appendix A S3531 Spectrum Analyzer Programming manual.

Users can also use the the PC software (SA Remote Control) provided by Saluki to get remote access to S3531 via LAN or USB port.

When S3531 is connected to controller, all operations should be done on controller. The keys on S3531 will not work. When disconnect S3531 from the controller, press ESC key to unlock other keys.

7.1 OS supported

- USB connection: Win XP, Win 7(32bit)
- LAN connection: Win XP, Win 7(32bit/64bit)

7.2 Software Installation Procedures

- 1) Copy the installation file zip pack into controller or a PC and un-zip it.

Saluki provide 2 installation for different Operation Systems

- SALUKI SARemoteControl_x64 for Windows 7 64bit
- SALUKI SARemoteControl_x86 for Windows 7 32 bit or Windows XP.

User may select the installation file based on their own operation system.

- 2) Open the folder and following items are contained in it.

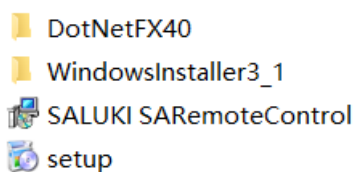

- DotNetFX40 is the netframe work 4.0, if the controller already have framework 4.0 or higher revision installed, user do not need to install it.
- WindowsInstaller3_1 is NI VISA support. It is a necessary component of the software
- SALUKI SARemoteControl: The installation file of the software.
- Setup: double click this file, it will run and detect the installation environment. Then install the software automatically.

- 3) Double click the "setup" file, following window pops out. Click "Next"

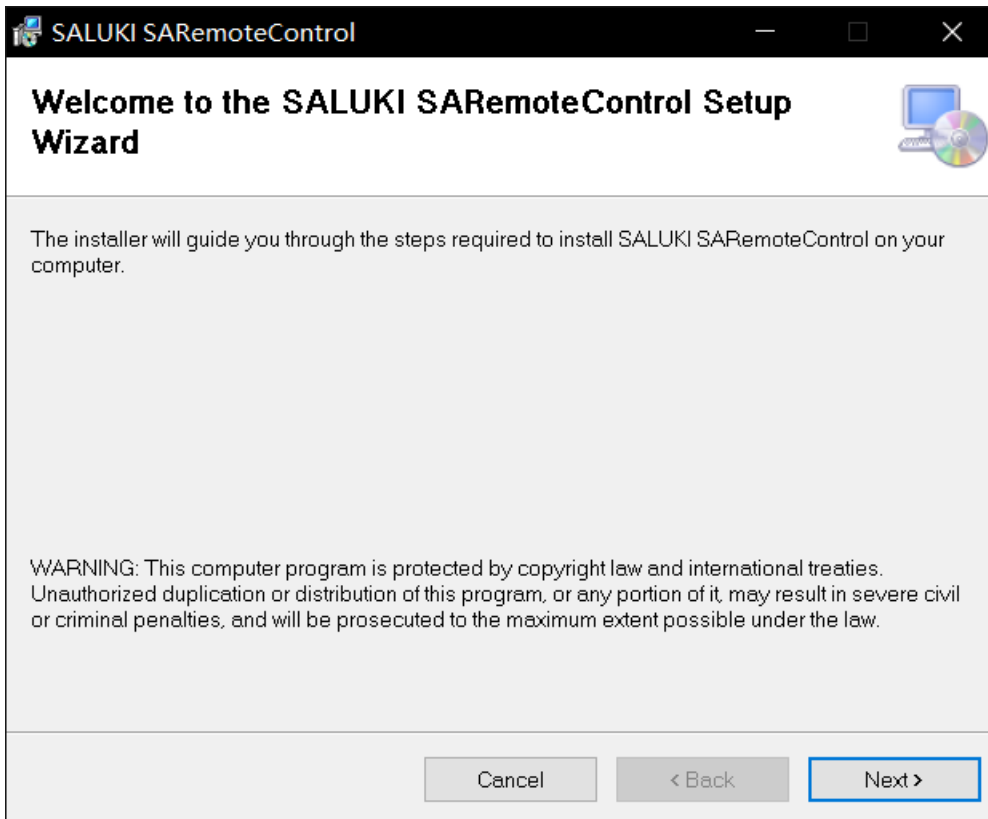

- 4) In following window, browse the folder to install the software, then click "Next"

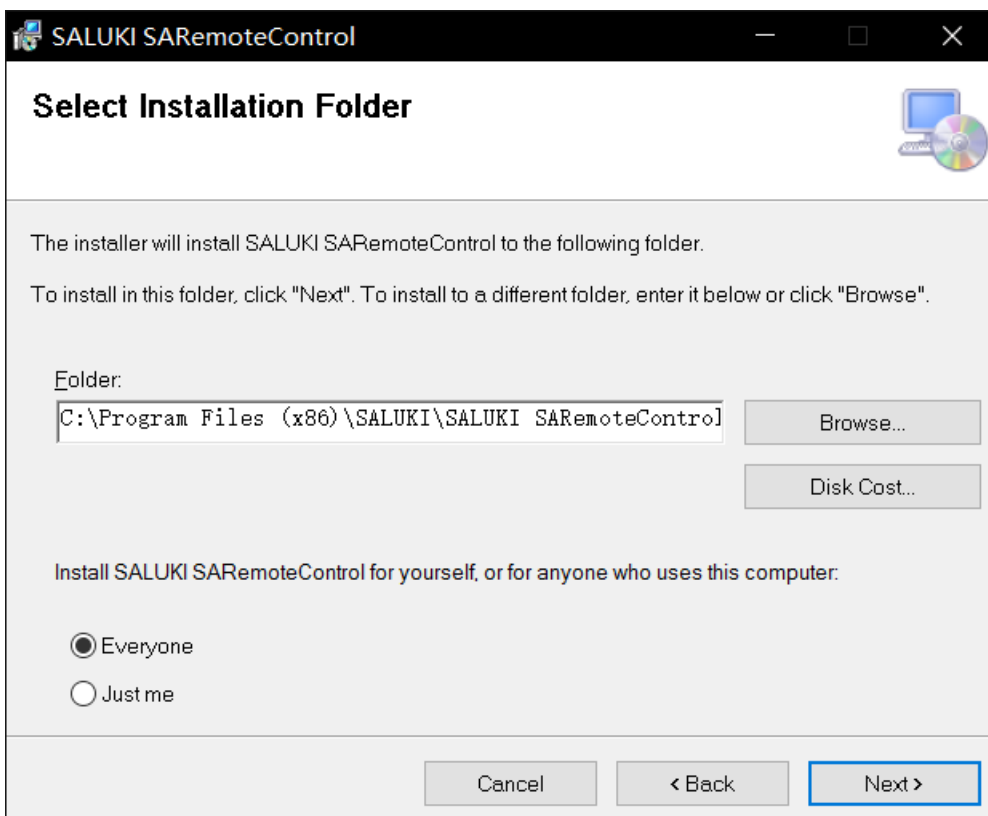

- 5) Click "Next" in following window and wait for the software to be installed.

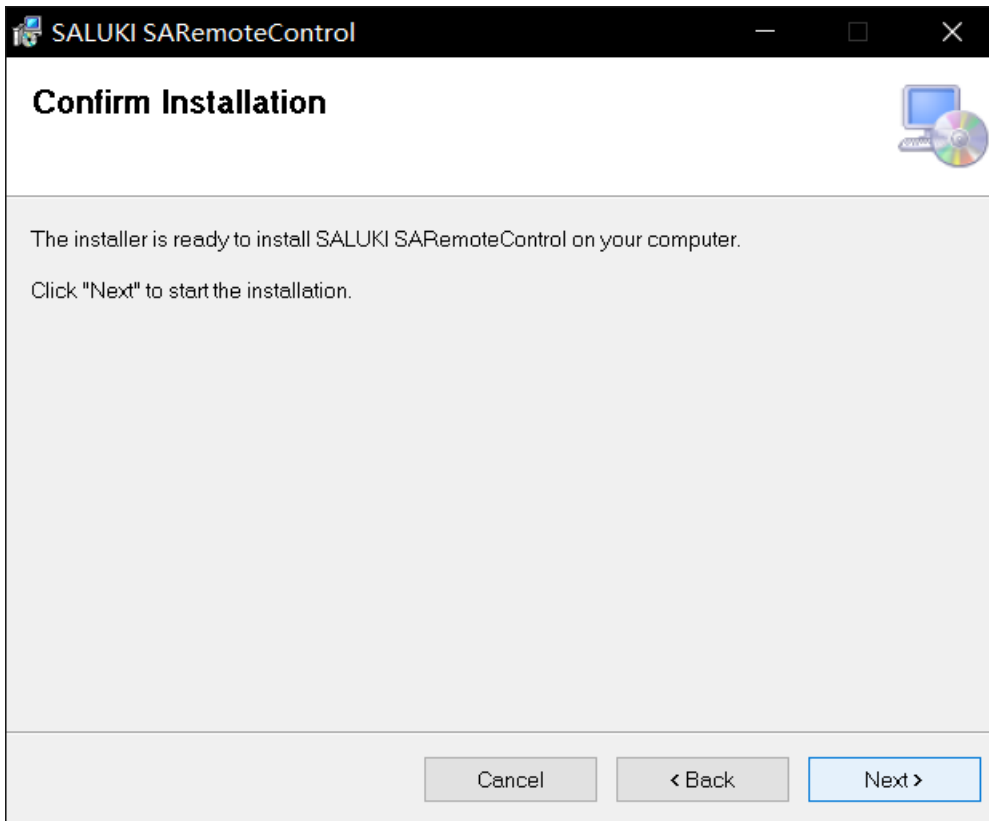

- 6) If framework 4.0 is not installed, framework installation wizard will pop out and please follow the wizard and complete the installation.
- 7) If NI VISA foundation is not installed, installation wizard will pop out and please follow the wizard to complete the installation
- 8) If user already get NI VISA foundation and Framework 4.0 or higher version installed, the Installation will complete and a shortcut will be created on desktop

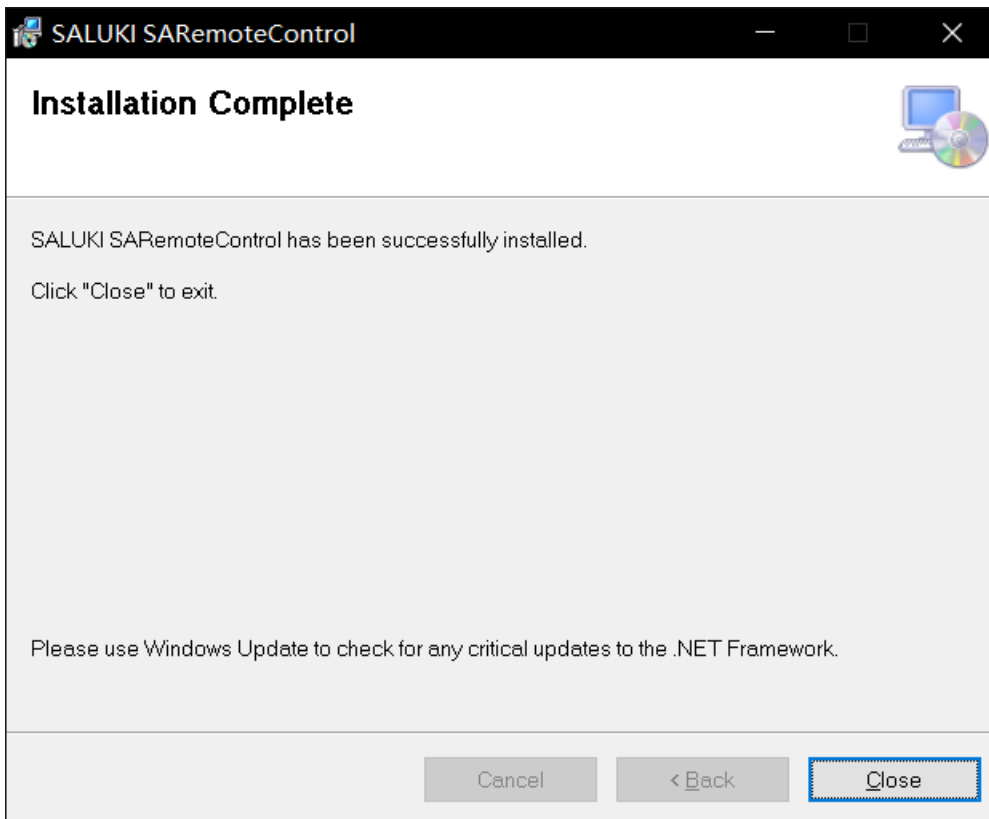

7.3 Connection

7.3.1 USB Port Connection

S3531 series spectrum analyzer can be connected to a controller via USB port. This function supports Window XP and Windows 7 32bit/64bit operation system. More OS will be supported in future. The USB connection support SCPI command control only.

1) Connect S3531 to PC via USB port

Connect the USB A type port (photo below) on the top of the instrument to a PC



2) Install the USB driver

When S3531 is connected to PC, a driver installation window will pop out. If the driver window is not pop out, please open the device manager, and find the USB device with a yellow triangle sign with an exclamation in it. Right click it and load the driver manually. All USB

drivers are saved in the installation directory folder. (default path is *C:\Program Files (x86)\SALUKI\SALUKI SARemoteControl\USB Driver\usb2030*). Please select the driver based on your operation system.

3) Check the device status

Open Device manager and check the device status. If the driver is installed successfully, it will under NI-VISA USB devices, please see the screen shot below:

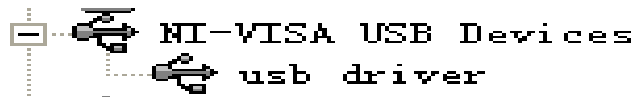

4) Telecommunication

Double click SARemoteControl software. Select USB table and click connect. No warning pops out and S3531 is connected. User can type in SCPI command to control or fetch data.

7.3.2 LAN connection

S3531 can be connected to LAN, user can use the Saluki remote control software to manage S3531. LAN connection not only provide SCPI command control, but also provide a UI. It is a mapping of the keys and display of the S3531.

1) Connect S3531 into LAN

Use CAT6 cable connect S3531 to a LAN or to PC directly.

2) Set PC and S3531 in the same sub-network

For example, set IP address to 192.168.1.1 (255.255.255.0), set S3531 IP address to 192.168.1.2 (255.255.255.0)

3) Double click the software icon

Fill S3531 IP address, use default port number and delay. Then click "Connect"

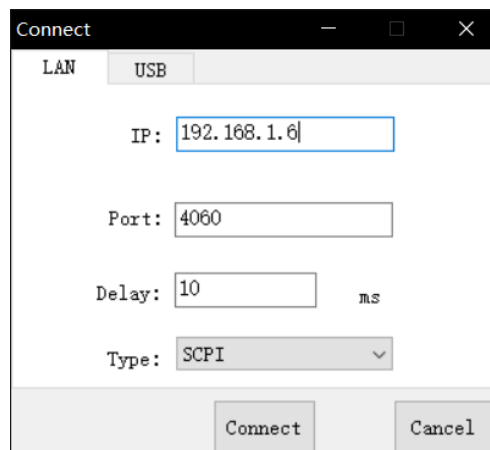

7.4 UI

Saluki SA Remote Control software provides 2 method for remote control.

- SCPI command (USB connection can only use this way)
- Keys and display (LAN connection only)

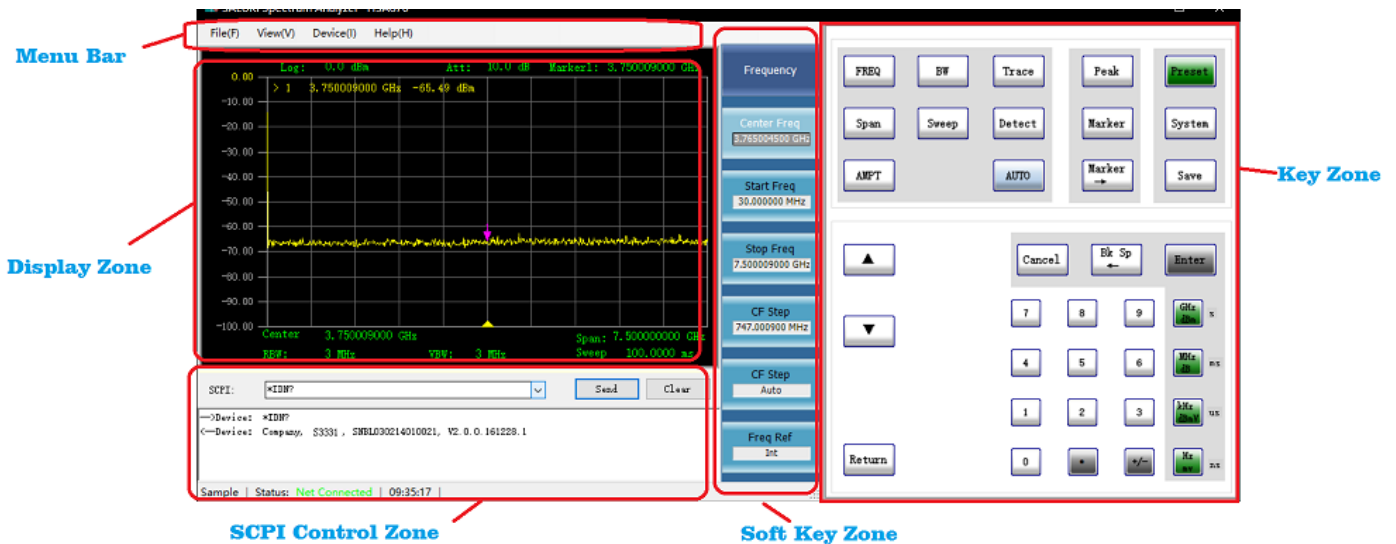

The UI can be divided into several zones

- Key Zone
- Soft Key Zone
- Menu Bar
- Display Zone

7.4.1 Key Zone

These keys are mapping to the physical keys on S3531 front panel. Please refer to section 3.1 Front Panel Overview and section 3.2 Function Keys Description for detail function of these keys.

7.4.2 Softkey Zone

This zone is used to display soft menu when any of keys in key zone is pressed. The function of this zone is similar to the Soft Keys described in section 3.3 Soft Keys.

7.4.3 SCPI control Zone

This zone is used to type in SCPI command and display the returned value. For more details of available command and returned value, please refer to Appendix A.

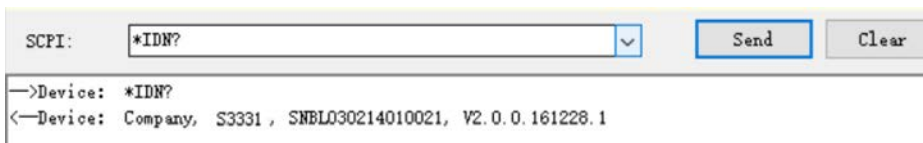

7.4.4 Display Zone

This zone is used to display the trace and information. It is a mapping of the display of the physical screen. Please refer to section 3.5 User Interface for more details.

7.4.5 Menu Bar

The menu bar will provide some system functions



7.4.5.1 File

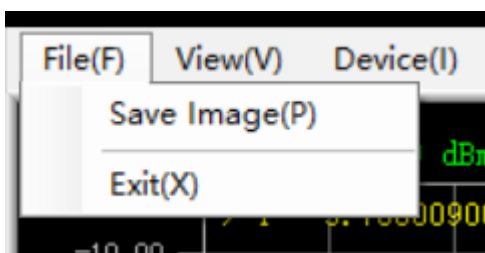

- Save image

It can be used to save the current display as a picture and save locally.

7.4.5.2 View

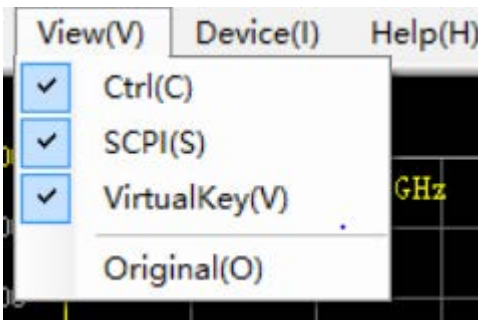

View menu is used to set the display of each function zone of the software. For example, if Ctrl, SCPI and Virtualkey is unpicked, the software UI will be like following screenshot and gives a better view for User to observe the measurement result

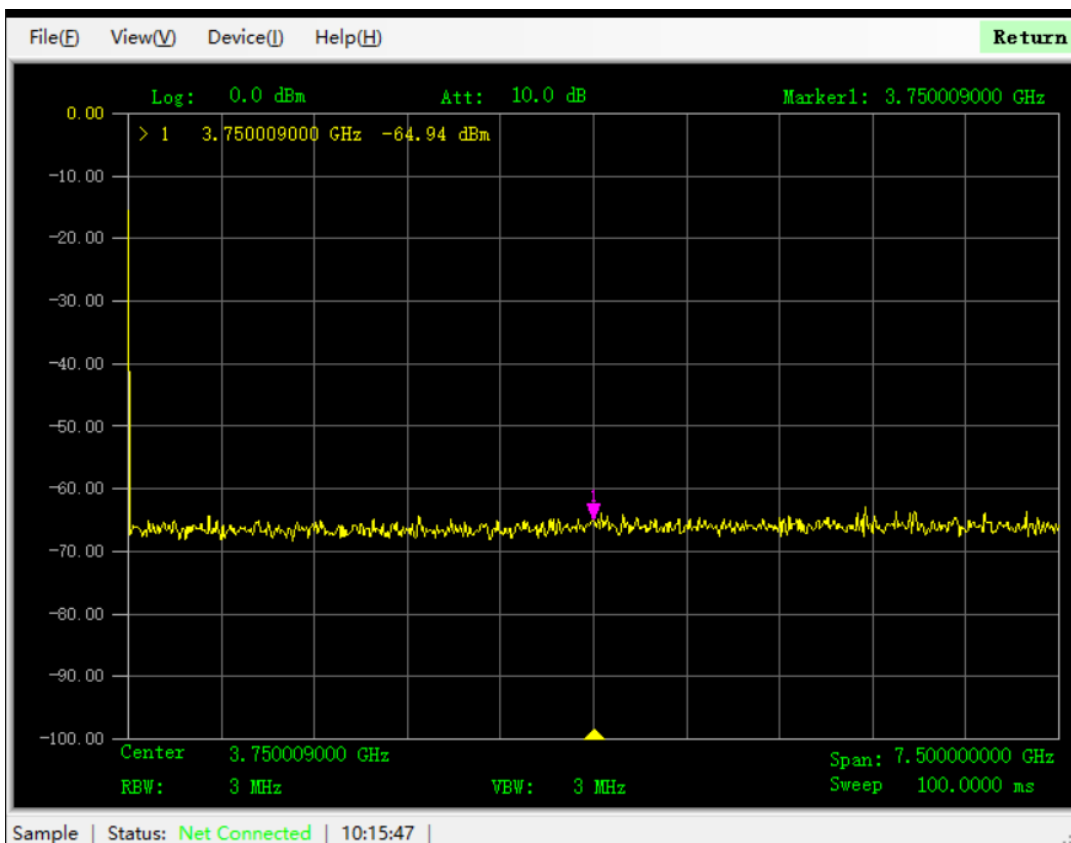

7.4.5.3 Device

Device menu is main used to control the connection

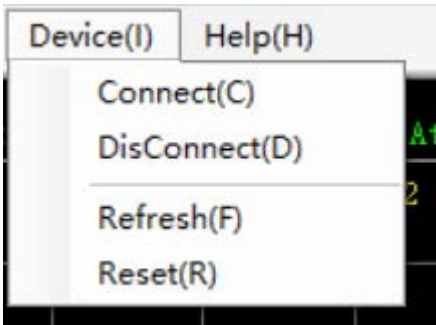

7.4.5.4 Help

Help menu is used to get the software information

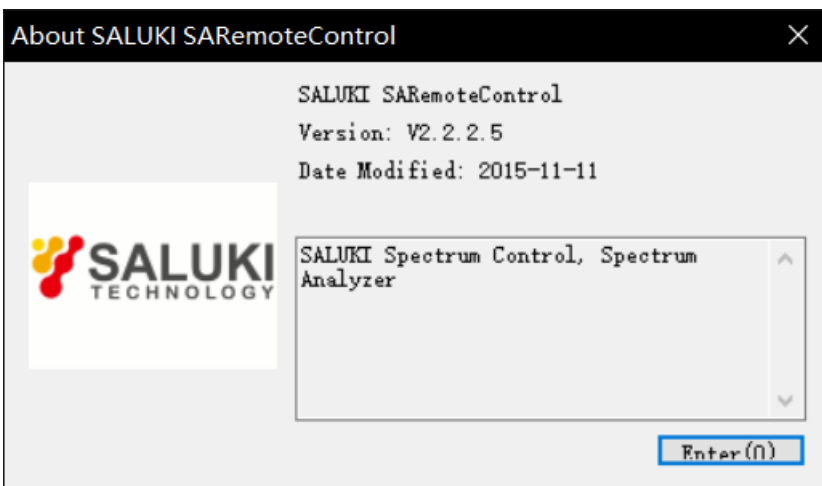

8 Specification Details

8.1 Frequency

	S3531A	S3531B
Frequency range	9kHz~1.8GHz	9kHz~3GHz
Resolution	1Hz	1Hz
Frequency readout accuracy	\pm (frequency indication \times frequency reference+1% \times span+10% \times RBW+0.5 \times [span/ (number of sweep points-1)]+1Hz)	\pm (frequency indication \times frequency reference+1% \times span+10% \times RBW+0.5 \times [span/ (number of sweep points-1)]+1Hz)
Aging Rate	\pm 1ppm/year	\pm 1ppm/year
Temperature stability	\pm 0.5ppm (15°C ~ 35°C)	\pm 0.5ppm (15°C ~ 35°C)

8.2 Amplitude

		S3531A	S3531B		
Amplitude					
Maximum safe input level	Average continuous power	+27dBm	+23dBm		
	DC voltage	50Vdc maximum	50Vdc maximum		
Input attenuator range		0 ~ 30dB, Steps of 3 dB	0 ~ 39dB, Steps of 1 dB		
1dB compression		+7dBm	+7dBm		
Amplitude Accuracy (20°C~ 30°C)					
Comprehensive amplitude accuracy (90%)		Input range: 0dBm to -50dBm	\pm 1.5dB	Input range: 0dBm to -50dBm	\pm 1.5dB

8.3 Input /Output

		S3531A	S3531B
RF Input/Output		Type -N female (50 Ω)	Type -N female (50 Ω)
USB		USB 1.1 B plug	USB 1.1 B plug
LAN		10/100 Base-T, RJ-45 Connectivity	10/100 Base-T, RJ-45 Connectivity
RS232		9-pin D-sub (M)	9-pin D-sub (M)
Reference input/output	10MHz, BNC female	Input level 0dBm ~ +10dBm	Input level 0dBm ~ +10dBm
		Output level 0dBm \pm 2dB	Output level 0dBm \pm 2dB

		S3531A	S3531B
Trig input	BNC female	5V TTL	5V TTL

8.4 RBW

	S3531A	S3531B
Range	1Hz - 3MHz	1Hz - 3MHz
Resolution filter shape factor(60dB/3dB)	<5: 1 (Typ.)	<5: 1 (Typ.)
Accuracy	<5% (Typ.)	<5% (Typ.)
Video bandwidth (VBW)	10Hz - 3MHz	10Hz - 3MHz

8.5 DANL (0dB attenuation , RBW=1Hz)

	S3531A		S3531B	
	Preamp off	Preamp on	Preamp off	Preamp on
100kHz ~ 1MHz	<-100dBm-3×(f/100kHz)dB	<-120dBm-3×(f/100kHz)dB	<-95dBm-3×(f/100kHz)dB	<-110dBm-3×(f/100kHz)dB
1MHz ~ 10MHz	<-130dBm	<-150dBm	<-130dBm	<-150dBm
10MHz ~ 1GHz	<-135dBm	<-155dBm	<-135dBm	<-155dBm
1GHz ~ 1.8GHz	<-130dBm	<-153dBm	<-130dBm	<-148dBm
1.8GHz - 3GHz	-	-	<-130dBm	<-148dBm

8.6 Phase Noise

	S3531A		S3531B	
SSB phase noise (RBW=1kHz, Sample detector, Trace average≥10)				
CF=500MHz	Carrier offset 30kHz	-90dBc/Hz	Carrier offset 30kHz	-90dBc/Hz
	Carrier offset 100kHz	-100dBc/Hz	Carrier offset 100kHz	-100dBc/Hz
	Carrier offset 1MHz	-115dBc/Hz	Carrier offset 1MHz	-115dBc/Hz

8.7 Sweep Time

	S3531A	S3531B
Sweep time		
Full Span	3ms ~ 3000s	3ms ~ 3000s
zero span	1ms ~ 3000s	1ms ~ 3000s

	S3531A	S3531B
Sweep mode	Continuous, single	Continuous, single

8.8 Spurious Response

	S3531A	S3531B
TOI >30MHz	+13dBm	+13dBm
SHI	+30dBm	+40dBm
Input related spurious	<-60dBc	<-60dBc
Inherent residual response	<-85dBm	<-85dBm

8.9 Tracking Generator (Option)

	S3531A	S3531B
Frequency range	100kHz - 1.8GHz	100kHz - 3GHz
Output level	-30dBm To 0dBm Stepped by 1 dB	-30dBm To 0dBm Stepped by 1 dB
Output flatness	±3dB	±3dB

8.10 General

		S3531A	S3531B
Display		8 inch TFT LCD	8 inch TFT LCD
Dimensions		335(H)×162(W)×116(D)mm	335(H)×162(W)×116(D)mm
Weight		4Kg	4Kg
Operating Temperature range		0°C to 50°C	0°C to 50°C
Storage Temperature range		-20°C to +70°C	-20°C to +70°C
Power	Input Voltage	100V-240V AC	100V-240V AC
	Input Frequency	40Hz - 60Hz	40Hz - 60Hz
	Consumption	Max 20W	Max 20W

9 Appendix A Programming Manual