

R&S® NGE100B

Power Supply

User Manual



5601134302
Version 09

ROHDE & SCHWARZ
Make ideas real



This manual describes the following R&S®NGE100B models with firmware version 1.55 and higher:

- R&S®NGE102B 2-Channel PSU (5601.3800.02)
- R&S®NGE103B 3-Channel PSU (5601.3800.03)

In addition to the base unit, the following options are described:

- R&S®NGE-K101 Ethernet Remote Control (5601.2204.03)
- ¹R&S®NGE-K102 Wireless LAN Remote Control (5601.2210.03)
- R&S®NGE-K103 Digital Trigger I/O (5601.2227.03)

¹ Only available for instrument with serial number below 110000

© 2022 Rohde & Schwarz GmbH & Co. KG
Muehldorfstr. 15, 81671 Muenchen, Germany
Phone: +49 89 41 29 - 0
Email: info@rohde-schwarz.com
Internet: www.rohde-schwarz.com

Subject to change – data without tolerance limits is not binding.

R&S® is a registered trademark of Rohde & Schwarz GmbH & Co. KG.

Trade names are trademarks of the owners.

5601.1343.02 | Version 09 | R&S®NGE100B

The following abbreviations are used throughout this manual: R&S®NGE100B is abbreviated as R&S NGE100B. R&S® is abbreviated as R&S.

Contents

1	Preface	7
1.1	Safety information.....	7
1.2	Korea certification class A.....	7
1.3	Documentation overview.....	7
1.3.1	Manuals.....	7
1.3.2	Data sheet.....	8
1.3.3	Calibration certificate.....	8
1.3.4	Release notes, open source acknowledgment.....	8
1.4	Conventions used in the documentation.....	9
1.4.1	Typographical conventions.....	9
1.4.2	Notes on screenshots.....	9
2	Welcome to R&S NGE100B	10
3	Important notes	11
3.1	Symbols.....	11
3.2	Ambient conditions.....	11
3.3	Measurement categories.....	12
3.4	Mains voltage.....	12
3.5	Limits.....	13
4	Getting started	14
4.1	Putting into operation.....	14
4.1.1	Safety.....	15
4.1.2	Intended operation.....	16
4.1.3	Unpacking and checking the instrument.....	18
4.1.4	Setting up the instrument.....	18
4.1.4.1	Bench operation.....	19
4.1.4.2	Rack mounting.....	19
4.2	Instrument tour.....	20
4.2.1	Overview of controls.....	20
4.2.1.1	Front panel.....	20
4.2.1.2	Rear panel.....	22

4.2.2	Switching on the instrument.....	24
4.3	Trying out the instrument.....	25
4.3.1	Selecting the channels.....	25
4.3.2	Setting the output voltage and current limit.....	25
4.3.3	Activating the channels output.....	26
4.3.4	Storing/Recalling of instrument settings.....	26
5	Operating basics.....	27
5.1	Display overview.....	27
5.1.1	Status bar information.....	27
5.1.2	Channel display area.....	28
5.2	Front panel keys.....	30
5.2.1	Function keys.....	30
5.2.1.1	Output and channel controls.....	31
5.2.1.2	Navigation keys.....	31
5.2.1.3	Instrument functions.....	31
5.2.1.4	Memory functions.....	32
5.2.2	Navigation controls.....	32
5.2.2.1	Rotary knob.....	32
5.2.2.2	Arrow keys.....	33
5.2.2.3	Live-mode.....	33
5.2.3	Menu key.....	33
5.3	On-screen keyboard.....	36
5.4	Power derating.....	36
5.5	Operation modes.....	37
6	Instrument functions.....	39
6.1	Setting the voltage and current.....	39
6.2	Activating the channels output.....	40
6.3	Electronic fuse.....	41
6.3.1	Activating fuse.....	41
6.3.2	Fuse delay, fuse linking.....	42
6.4	Tracking function.....	43
6.5	Protection.....	44
6.6	Digital trigger I/O.....	45

6.7	Advanced functions.....	48
6.7.1	EasyArb.....	49
6.7.2	EasyRamp.....	50
6.8	Store and recall.....	52
6.9	Interfaces and protocols.....	54
6.9.1	Network connection.....	54
6.9.1.1	LAN connection.....	54
6.9.1.2	Wireless LAN connection.....	56
6.9.2	USB connection.....	58
6.9.3	LXI.....	60
6.9.4	SCPI.....	62
6.9.5	VISA.....	62
6.9.6	Setting up remote control connection.....	62
6.10	General instrument settings.....	63
6.10.1	Instrument information.....	64
6.10.2	General instrument settings.....	65
6.10.3	Managing options.....	65
6.10.4	Reset instrument.....	66
6.10.5	System test.....	67
6.10.6	Updating the firmware.....	68
6.10.7	Help.....	69
7	Remote control commands.....	70
7.1	Common setting commands.....	70
7.2	System commands.....	73
7.3	Configuration commands.....	76
7.3.1	Channel selecting.....	76
7.3.2	Voltage setting.....	78
7.3.3	Current setting.....	79
7.3.4	Combined voltage and current settings.....	80
7.3.5	Output setting.....	80
7.3.6	Fuse setting.....	83
7.3.7	OVP setting.....	87
7.3.8	OPP setting.....	90

7.4	Measurement commands.....	93
7.5	Advanced operating commands.....	93
7.5.1	Arbitrary commands.....	94
7.5.2	EasyRamp commands.....	96
7.5.3	DIO commands.....	97
7.6	Data and file management commands.....	102
7.7	Firmware update.....	102
8	Maintenance and support.....	103
8.1	Maintenance.....	103
8.2	Contacting customer support.....	103
9	Applications.....	105
9.1	Parallel and series mode.....	105
9.1.1	Series mode.....	105
9.1.2	Parallel mode.....	106
	Annex.....	108
A	Additional basics on remote control.....	108
A.1	Messages and command structure.....	108
A.1.1	Messages.....	108
A.1.2	SCPI command structure.....	109
A.2	Command sequence and synchronization.....	113
A.2.1	Preventing overlapping execution.....	113
	List of commands.....	114
	Index.....	116

1 Preface

1.1 Safety information

The product documentation helps you use the R&S NGE100B safely and efficiently. Follow the instructions provided here and in the printed "Basic Safety Instructions". Keep the product documentation nearby and offer it to other users.

Intended use

The R&S NGE100B is intended for the development, production and verification of electronic components and devices in industrial, administrative, and laboratory environments. Use the R&S NGE100B only for its designated purpose. Observe the operating conditions and performance limits stated in the data sheet.

Where do I find safety information?

Safety information is part of the product documentation. It warns you about the potential dangers and gives instructions how to prevent personal injuries or damage caused by dangerous situations. Safety information is provided as follows:

- The printed "Basic Safety Instructions" provide safety information in many languages and are delivered with the R&S NGE100B.
- Throughout the documentation, safety instructions are provided when you need to take care during setup or operation.

1.2 Korea certification class A



이 기기는 업무용(A급) 전자파 적합기기로서 판매자 또는 사용자는 이 점을 주의하시기 바라며, 가정외의 지역에서 사용하는 것을 목적으로 합니다.

1.3 Documentation overview

This section provides an overview of the R&S NGE100B user documentation.

1.3.1 Manuals

You find the documents on the R&S NGE100B product page at:

www.rohde-schwarz.com/product/nge100b

Getting started

Introduces the R&S NGE100B power supply series and describes how to set up and start working with the instrument. The printed document is delivered with the instrument.

User manual

Contains the description of all instrument modes and functions. It also provides an introduction to remote control, a complete description of the remote control commands with programming examples, and information on maintenance and instrument interfaces. Includes the contents of the getting started manual.

The *online version* of the user manual provides the complete contents for immediate display on the internet.

Basic safety instructions

Contains safety instructions, operating conditions and further important information. The printed document is delivered with the instrument.

1.3.2 Data sheet

The datasheet contains the technical specifications of the R&S NGE100B power supply series. It also lists all options with their order numbers and accessories.

See www.rohde-schwarz.com/brochure-datasheet/nge100b

1.3.3 Calibration certificate

The document is available on <https://gloris.rohde-schwarz.com/calcert>. You need the device ID of your instrument, which you can find on a label on the rear panel.

1.3.4 Release notes, open source acknowledgment

The release notes list new features, improvements and known issues of the current firmware version, and describe the firmware installation. The open source acknowledgment document provides verbatim license texts of the used open source software. It can also be downloaded from the instrument.

See www.rohde-schwarz.com/firmware/nge100b.

1.4 Conventions used in the documentation

1.4.1 Typographical conventions

The following text markers are used throughout this documentation:

Convention	Description
"Graphical user interface elements"	All names of graphical user interface elements on the screen, such as dialog boxes, menus, options, buttons, and softkeys are enclosed by quotation marks.
[Keys]	Key and knob names are enclosed by square brackets.
Filenames, commands, program code	Filenames, commands, coding samples and screen output are distinguished by their font.
<i>Input</i>	Input to be entered by the user is displayed in italics.
Links	Links that you can click are displayed in blue font.
"References"	References to other parts of the documentation are enclosed by quotation marks.

1.4.2 Notes on screenshots

When describing the functions of the product, we use sample screenshots. These screenshots are meant to illustrate as many as possible of the provided functions and possible interdependencies between parameters. The shown values may not represent realistic usage scenarios.

The screenshots usually show a fully equipped product, that is: with all options installed. Thus, some functions shown in the screenshots may not be available in your particular product configuration.

2 Welcome to R&S NGE100B

The two or three-channel power supply series are based on a classical transformer concept with high efficiency electronic pre-regulators and secondary linear regulators. This concept allows the instrument to achieve the high output power within a minimum space, high efficiency and lowest residual ripple.

The R&S NGE100B power supply series feature galvanically isolated, floating overload and short-circuit proof outputs with adjustable power ratings. The outputs can be connected in series or in parallel, thus making high currents and voltages available.

Multi-purpose protection functions are available for each channel which you can set separately, such as overcurrent protection (FUSE), overvoltage protection (OVP), over-power protection (OPP) and overtemperature protection (OTP). If such a limit is reached, the affected output channel is automatically turned off and an indicator message (FUSE, OVP, OPP or OTP) is displayed. The overcurrent protection can be linked to other channel (FuseLink function). In this case, all linked channels are turned off when the set channel reaches its limit.

The EasyArb function allows channel 1 (Ch 1) to have freely definable voltage and current sequences with a timeframe as short as 10 ms. It allows you to vary the voltage or current limit during a test sequence, for example to simulate different charging conditions of a battery. With EasyRamp function, the R&S NGE100B provides the operating condition to simulate the continuous rise of the supply voltage within a defined timeframe of 10 ms to 10 s.







Four data lines of the digital I/O interface are mutually independent and can be used as trigger input or trigger output separately. Various trigger conditions (e.g. fuse tripped, voltage, current, indicator messages) can be used to turn off, on or invert the output state when the trigger condition is met.

All R&S NGE100B power supply series are equipped with a color LCD display (320 x 240 pixels resolution). The R&S NGE100B comes with a USB interface and optional LAN (LXI) interface.

This user manual contains a description of the functionalities that the instrument provides. The latest version is available for download at the product homepage (<http://www.rohde-schwarz.com/product/nge100b>).

3 Important notes

3.1 Symbols

	Caution, general danger zone
	Ground
	PE terminal
	ON (supply voltage)
	OFF (supply voltage)
	Ground terminal

3.2 Ambient conditions

The allowed operating temperature ranges from +0 °C to +40 °C (pollution category 2). The maximum relative humidity (without condensation) is at 80 %.

During storage and transport, the temperature must be between -20 °C and +70 °C. In case of condensation during transportation or storage, the instrument requires approximately two hours to dry and reach the appropriate temperature prior to operation. The instrument is designed for use in a clean and dry indoor environment. Do not operate with high dust and humidity levels, if danger of explosion exists or with aggressive chemical agents.

Any operating position may be used; however adequate air circulation must be maintained. For continuous operation, a horizontal or inclined position (integrated stand) is preferable.

Specifications with tolerance data apply after a warm-up period of at least 30 minutes at a temperature of 23 °C (tolerance -3 °C / + 7 °C). Specifications without tolerance data are average values.

The heat produced inside the instrument is guided to the exterior via temperature-controlled fan. Each channel has multiple temperature sensors which check the heat generation in the instrument and control the fan speed.

It is necessary to ensure that there is sufficient space around the instrument sides for heat exchange. If the temperature inside the instrument increases more than the

allowed limit, overtemperature protection is triggered and the affected outputs are switched off automatically.

CAUTION

Air circulation

Do not obstruct the ventilation holes!

3.3 Measurement categories

This instrument is designed for supplying power-on circuits that are only indirectly connected to the low voltage mains or not connected at all. The instrument is not intended for measurements within the measurement categories II, III or IV; the maximum potential against earth generated by the user must not exceed 150 VDC in this application.

The following information refers solely to user safety. Other aspects, such as the maximum voltage, are described in the technical data and must also be observed.

The measurement categories refer to transients that are superimposed on the mains voltage. Transients are short, very fast (steep) current and voltage variations which may occur periodically and non-periodically. The level of potential transients increases as the distance to the source of the low voltage installation decreases.

- Measurement CAT IV: Measurements at the source of the low voltage installations (e.g. meters)
- Measurement CAT III: Measurements in building installations (e.g. power distribution installations, power switches, firmly installed sockets, firmly installed engines etc.)
- Measurement CAT II: Measurements on circuits electronically directly connected to the mains (e.g. household appliances, power tools, etc.)
- 0 (instruments without measured measurement category): Other circuits that are not connected directly to the mains

3.4 Mains voltage

The instrument uses 50 Hz / 60 Hz mains voltages ranging from 115 VAC or 230 VAC (tolerance $\pm 10\%$). Mains voltage switching is not intended. The input line fuse is accessible externally. Power socket and fuse holder form a single unit.

You need to first disconnect the power cord from the connector before you can safely replace the fuse (as long as the fuse holder is undamaged). Next, the fuse holder must be pried out using a screwdriver. The starting point is a slot next to the contacts. The fuse can then be forced out of its mounting and must be replaced with an identical fuse (see information about the fuse type on the rear panel). The fuse holder is inserted against the spring pressure until it locks into place. The use of mended fuses or short

circuiting the fuse holder is prohibited. Resulting damages are not covered by the warranty.

NOTICE

Safe operation

If the instrument is not in use, it must be switched off at the mains switch for safety reasons.

3.5 Limits

The R&S NGE100B is equipped with a protective overload feature. The protective overload feature prevents damage to the instrument and is intended to protect against a possible electrical shock. The maximum values for the instrument must not be exceeded. The protection limits are listed on the front panel of the R&S NGE100B to ensure the safe operation of the instrument.

These protection limits must be adhered to:

Specification	Limits
Maximum output voltage	32 VDC
Maximum output current	3 A (max 33.6 W per channel)
Maximum voltage against earth	150 VDC
Maximum reverse voltage	33 VDC
Maximum inverse voltage	0.4 VDC
Maximum permitted current in case of inverse voltage	3.01 A
Power supply	115 VAC or 230 VAC (tolerance $\pm 10\%$)
Frequency	50 Hz / 60 Hz
Maximum power output	100 W (R&S NGE103B), 66 W (R&S NGE102B)

4 Getting started

4.1 Putting into operation

This chapter describes the steps to set up the R&S NGE100B for the first time.

⚠ WARNING**Risk of injury and instrument damage**

The instrument must be used in an appropriate manner to prevent electric shock, fire, personal injury, or damage.

- Do not open the instrument casing
- Read and observe the "Basic Safety Instructions" delivered as a printed brochure with the instrument. Note that the basic safety instructions also contain information on operating conditions that prevent damage to the instrument

In addition, read and observe the safety instructions in the following sections. Notice that the data sheet may specify additional operating conditions.

NOTICE**Risk of instrument damage during operation**

An unsuitable operating site or test setup can cause damage to the instrument and the connected devices. Ensure the following operating conditions before you switch on the instrument:

- The instrument is dry and shows no sign of condensation
 - The instrument is positioned as described in [Chapter 4.1.4.1, "Bench operation"](#), on page 19
 - The ambient temperature does not exceed the range specified in the data sheet
 - Voltage levels at the input connectors are all within the specified ranges
 - Voltage outputs are correctly connected and not overloaded
-

⚠ WARNING**Risk of radio interference**

This is a class A product. In a domestic environment, this product may cause radio interference in which case the user may be required to take adequate measures.

**EMI impact on measurement results**

Electromagnetic interference (EMI) may affect the measurement results.

To suppress the generated EMI:

- Use suitable shielded cables of high quality, for example, LAN cables
- Note the EMC classification in the data sheet

• Safety	15
• Intended operation	16
• Unpacking and checking the instrument	18
• Setting up the instrument	18

4.1.1 Safety**NOTICE****Recommendations on secure operation**

The R&S NGE100B is designed to operate at local workplaces or in secured networks (LAN). It should not be accessible from the internet, because of a potential security risk, e.g. attackers could misuse or damage your device.

Please always install the latest firmware.

It is highly recommended that you work closely with your IT department or system administrator to ensure compliance with your company policies when connecting devices to your company's network.

This instrument was built in compliance with DIN EN 61010-1 (VDE 0411 part 1), safety regulations for electrical instruments, control units and laboratory equipment. It has been tested and shipped from the plant in safe condition. It is also in compliance with the regulations of the European standard EN 61010-1 and the international standard IEC 61010-1.

To maintain this condition and ensure safe operation, you must observe all instructions and warnings given in this user manual. Casing, chassis and all measuring ports are connected to a protective earth conductor. The instrument is designed in compliance with the regulations of protection class I.

For safety reasons, the instrument may only be operated with authorized safety sockets. The power cord must be plugged in before signal circuits may be connected.

Never use the product if the power cable is damaged. Check regularly that the power cables are in perfect condition. Choose suitable protective measures and installation types to ensure that the power cord cannot be damaged and that no harm is caused by tripping hazards or from electric shock, for instance.

⚠ DANGER**Risk of electric shock**

It is prohibited to disconnect the earthed protective connection inside or outside of the instrument!

If it is assumed that a safe operation is no longer possible, the instrument must be shut down and secured against any unintended operation.

Safe operation can no longer be assumed as follows:

- Instrument shows visible damage
- Instrument includes loose parts
- Instrument no longer functions properly
 - After an extended period of storage under unfavorable conditions (e.g. outdoors or in damp rooms)
 - After rough handling during transport (e.g. packaging that does not meet the minimum requirements by post office, railway or forwarding agency)

⚠ DANGER**Exceeding the low voltage protection**

Use insulated wires and not bare wires for the terminal connection.

For the series connection of all output voltages, it is possible to exceed the low voltage protection of 42 V. Please note that in this case any contact with live components is life-threatening. It is assumed that only qualified and trained personnel service the power supplies and the connected loads.

Before switching on the product, it must be ensured that the nominal voltage setting on the product matches the nominal voltage of the AC supply network. If it is necessary to set a different voltage, the power fuse of the product must be changed accordingly.

4.1.2 Intended operation

The instrument is intended only for use by personnel familiar with the potential risks of measuring electrical quantities.

For safety reasons, the instrument may only be connected to properly installed safety socket outlets. Separating the ground is prohibited.

The power plug must be inserted before signal circuits may be connected.



Use only the power cord included in the delivery package. See "[Delivery package](#)" on page 18.

Before each measurement, measuring cables must be inspected for damage and replaced if necessary. Damaged or worn components can damage the instrument or cause injury.

The product may be operated only under the operating conditions and in the positions specified by the manufacturer, without the product's ventilation being obstructed. If the manufacturer's specifications are not observed, this can result in electric shock, fire and/or serious personal injury, and in some cases, death.

Provide adequate airflow

Do not block the air intake at the front and side of the instrument or the exhaust at the rear. Install the instrument on a location that allows sufficient space for air circulation at the air intake and exhaust. Recommended spacing to non-heat producing surface is at least 2.5 inches (63.5 mm) from the ventilation holes.

Applicable local or national safety regulations and rules for the prevention of accidents must be observed in all work performed.

The instrument is designed for use in the following sectors: Industrial, residential, business and commercial areas and small businesses.

The instrument is designed for indoor use only. Before each measurement, you need to verify at a known source if the instrument functions properly.



To disconnect from the mains, the low-heat device socket on the back panel has to be unplugged.

See [Table 4-1](#) for the general data on the instrument specification. For more information, see the instrument product brochure (PN: 5214.8748.12).

Table 4-1: General data on instrument specification

Mains nominal voltage	AC	115 V / 230 V (±10 %) 50 Hz / 60 Hz
Power consumption	Maximum input power	180 W
Mains fuses (fuse size: 5 mm x 20 mm)	115 V AC	IEC 60127-2/5 T 5 A 250 V
	230 V AC	IEC 60127-2/5 T 2.5 A 250 V
Temperature	Operating temperature range	0 °C to + 40 °C
	Storage temperature range	- 20 °C to + 70 °C
Humidity	Non-condensing	5 % to 80 %
Display		3.5 " (QVGA)
Rack mount capability	½ 19 "	R&S HZC95 option
Dimensions	W x H x D	222 mm x 88 mm x 280 mm (8.74 in x 3.46 in x 11.02 in)
Weight	R&S NGE102B	4.9 kg (10.80 lb)
	R&S NGE103B	5.0 kg (11.02 lb)

4.1.3 Unpacking and checking the instrument

Check the equipment for completeness using the delivery note and package contents list for the various items. Check the instrument for any damage and loose parts. If there is any damage, immediately contact the carrier who delivered the instrument.



Packing material

Retain the original packing material. If the instrument needs to be transported or shipped at a later date, you can use the material to protect the control elements and connectors.

NOTICE

Risk of damage during transportation and shipment

Insufficient protection against mechanical and electrostatic effects during transportation and shipment can damage the instrument.

- Always ensure that sufficient mechanical and electrostatic protections are provided
- When shipping an instrument, the original packaging should be used. If you do not have the original packaging, use sufficient padding to prevent the instrument from moving around inside the box. Pack the instrument in antistatic wrap to protect it from electrostatic charging
- Secure the instrument to prevent any movement and other mechanical effects during transportation

Delivery package

The package contents contain the following items:

- R&S NGE100B power supply preloaded with two 230 V fuses
- Four power cables
- Two 115 V fuses (replace the preloaded fuses with these fuses depending on the mains voltage, see [Chapter 4.2.2, "Switching on the instrument"](#), on page 24 for more information)
- One 5-pin plug (P/N: 3643.6463.00) for digital I/O port connections
- One Getting Started manual
- One document folder containing Basic Safety instructions guide and CE certificate

4.1.4 Setting up the instrument

The R&S NGE100B is designed for benchtop and rackmount.

4.1.4.1 Bench operation

On a benchtop, the R&S NGE100B can either lie flat or stand on its feet. As shown in [Figure 4-1](#), feet on the bottom can be folded out to set the instrument in an inclined position.



Figure 4-1: Operating positions

NOTICE

Positioning of instrument

The instrument must be positioned in a manner that allows the user to disconnect the unit from the mains at any time and without restrictions.

WARNING

Risk of injury if feet are folded out

The feet can fold in if they are not folded out completely or if the instrument is shifted. Collapsing feet can cause injury or damage the instrument.

- Fold the feet completely in or out to ensure stability of the instrument. Never shift the instrument when the feet are folded out.
 - When the feet are folded out, do not work under the instrument or place anything underneath.
 - The feet can break if they are overloaded. The overall load on the folded-out feet must not exceed 250 N.
-

4.1.4.2 Rack mounting

The instrument can be installed in a 19" rack-mount using a rack adapter kit.

NOTICE**Ambient temperature**

Operate R&S NGE100B power supply in an area where the ambient temperature is within +0 °C to +40 °C. The R&S NGE100B power supply is fan-cooled and must be installed with sufficient space along the sides to allow proper air circulation. Ensure that fan openings are unobstructed and airflow vents are unimpeded.

Operating the instrument with insufficient airflow or outside the allowable ambient temperature can disrupt the operation and even cause damage.

4.2 Instrument tour

This chapter provides an overview of all the controls available in the R&S NGE100B models and steps to switch on the instrument for the first time.

4.2.1 Overview of controls

4.2.1.1 Front panel

The front panel of the R&S NGE100B is as shown in [Figure 4-2](#). The function keys and navigation controls are located at the right side of the display. The various connectors are located below the display and function keys.

The following power supply models are available:

Table 4-2: Power supply models

Models	Number of output channels
R&S NGE102B (0 V - 32 V/3 A)	2 (maximum 66 W)
R&S NGE103B (0 V - 32 V/3 A)	3 (maximum 100 W)



Figure 4-2: Front panel of R&S NGE100B with 3 channels

- 1 = Display
- 2 = Function keys
- 3 = Rotary knob and arrow keys
- 4 = Output channels (see [Table 4-2](#))
- 5 = USB connector
- 6 = Power key

Display (1)

The display is a color LCD screen. Depending on the instrument models, up to three channels are shown on the screen. The respective measurement settings and functions are displayed in the individual channel section. There is a status bar above the channel section to indicate the function used and operation mode of the instrument.

For a detailed description on-screen layout, see section "Screen Layout" in the User Manual.

Function keys (2)

Function keys are means of input for manual operation of the instrument functions. When a function key is pressed, all the related keys are also illuminated.

For detailed description on function keys, see section "Function Keys" in the User Manual.

Rotary knob and arrow keys (3)

Rotary knob and arrow keys are means of navigation and adjustment. When pressed or rotated, they perform tasks like navigation around the screen, adjustment of parameter values or confirmation of entries.

For detailed description on rotary knob and arrow keys, see section "Navigation Controls" in the User Manual.

Output channels (4)

Depending on the instrument models, up to three output channels are available for output of power to the connected load. See [Table 4-2](#).

USB connector (5)

USB Type-A connector is provided for connecting a USB flash drive to perform firmware update and store screen captures.

The USB flash drive file system supports FAT32 only.

Power key (6)

The [Power] key switches the instrument on and off.

4.2.1.2 Rear panel

[Figure 4-3](#) shows the rear panel of the R&S NGE100B with its connectors.

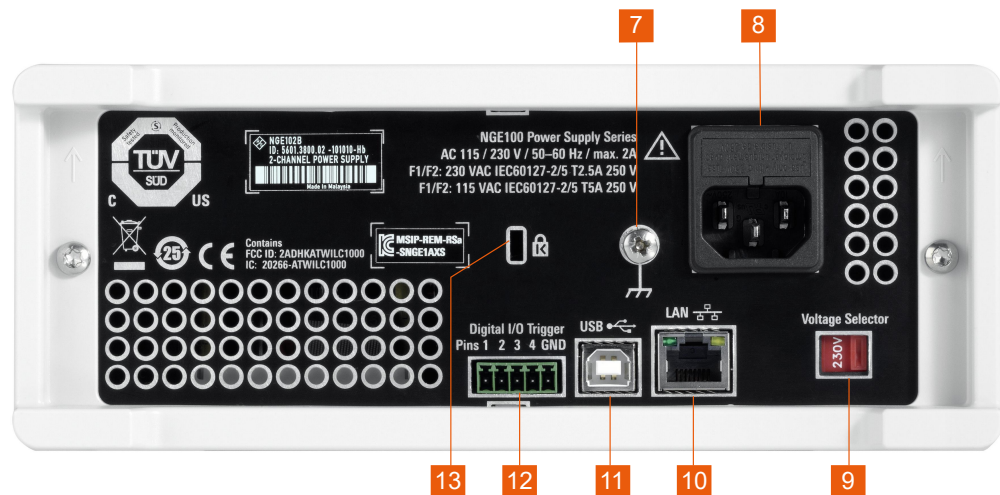

Figure 4-3: Rear panel of R&S NGE100B

- 7 = Ground terminal
- 8 = AC inlet with fuse holder
- 9 = Voltage selector
- 10 = Ethernet (LAN) connector
- 11 = USB connector
- 12 = Digital I/O connector
- 13 = Kensington lock

Ground terminal (7)

M4 screw provides connection to earth ground through the instrument ground/chassis.

AC inlet with fuse holder (8)



Main supply cord

Do not use detachable mains supply cord with inadequate rating.

For safety reasons, the instrument can only be operated with authorized safety sockets.

The power cable must be plugged in before signal circuits can be connected. Never use the product if the power cable is damaged. See [Chapter 4.2.2, "Switching on the instrument"](#), on page 24 for more information.

Voltage selector (9)

NOTICE

Setting voltage selector

The voltage selector is located at the bottom of the R&S NGE100B.

On your first power-on connection, a yellow label sticker is attached over the [AC inlet](#). Before peeling off the yellow label sticker, make sure the correct fuse rating is used for the mains voltage.

To set the correct fuse rating, slide the selector according to the voltage selector label.



Figure 4-4: Voltage selector

- 1 = Voltage selector
- 2 = Voltage selector label

The voltage selector selects the mains voltage between 115 V and 230 V. See [Table 4-1](#) for the fuse rating.

Ethernet connector (10)

This connector is used for establishing remote control via SCPI or LXI. See section "Ethernet Setup" in the user manual for more information on the connection setup.

The Ethernet option R&S NGE-K101 must be installed for this function to be available in the instrument.

USB connector (11)

The USB connector is a Type-B connector for remote control operation via USB TMC or USB VCP.

Digital I/O connector (12)

The Digital I/O connector is a 5-pin terminal block for external trigger input or output.

Measurement control can be achieved by means of an external input signal or as an output signal to trigger other instruments for some measurements.

The Digital Trigger I/O option (R&S NGE-K103) must be installed for this function to be available in the instrument.

Kensington security slot (13)

A Kensington lock can be anchored to the R&S NGE100B power supply housing to secure it to a workstation mechanically.

4.2.2 Switching on the instrument

Before switching on the instrument, check that all the instructions in the “Basic Safety Instruction” brochure and safety measures in previous sections are observed.

Also, check if the value on the voltage selector corresponds to the mains voltage (115 V or 230 V).

To change the power fuse / mains voltage setting:

1. Peel off the yellow label sticker on the AC inlet.
2. Pull out the fuse holder which is located directly on top of the socket.
3. Remove the preloaded fuses from the fuse holder.
4. Check the rating on the caps of both fuses that you want to change.
For more information, see "[Setting voltage selector](#)" on page 23.
5. Once verified, insert the fuses into each groove of the fuse holder.
6. Return the fuse holder to its position in the panel.

To switch on the instrument:

1. Connect the power cable to the AC power connector on the rear panel of the R&S NGE100B.
2. Connect the power cable to the socket outlet.
3. Press [Power] key on the front panel.
The instrument performs a system check, boots the operating system and starts the R&S NGE100B firmware.

By default, all output channels are turned off when the instrument is switched on to prevent connected loads from being damaged unintentionally.

During startup, the R&S NGE100B is loaded with the last saved instrument settings from memory location "M1" and auto saved parameters. See [Chapter 6.8, "Store and recall"](#), on page 52 in the User Manual.

To switch off instrument:

1. Press [Power] key.
2. Disconnect the AC power cable from the socket outlet.

4.3 Trying out the instrument

This chapter describes some basic functions that you can perform with the R&S NGE100B.

4.3.1 Selecting the channels

To select a channel, press the corresponding channel key. The key illuminates.

4.3.2 Setting the output voltage and current limit

To set the output voltage and current limit via live-mode:

1. Long press the rotary knob to enter into editing mode.
By default, the voltage at channel 1 is selected.
2. Use arrow keys to select the desired parameter (voltage or current).
3. Rotate the rotary knob to adjust value.
4. To exit live-mode, press the rotary knob.

Alternatively:

1. Press [Voltage] or [Current] key on the front panel.
2. Press the desired channel key to activate the respective voltage or current limit setting of that channel. The value on the respective channel becomes editable and is positioned by a blue cursor.
3. Press the [Left] or [Right] arrow key to move the cursor.
4. Press the [Up]/[Down] arrow key or turn the rotary knob to change the value.
The new value registers immediately.

4.3.3 Activating the channels output

The output voltages can be switched on or off regardless of the operating mode of the instrument.

To activate the channel output, press the [Output] key on the front panel followed by the desired channel key or vice versa.

Depending on the instrument operating mode, the display font color changes to green in CV (constant voltage) mode and red in CC (constant current) mode.

4.3.4 Storing/Recalling of instrument settings

The instrument settings can be stored in the instrument memory by long pressing the [Store Recall] key followed by the desired memory location key ([M1] to [M5]). The previous saved settings are overwritten.

To retrieve the settings, press [Store Recall] key and select the desired memory location key ([M1] to [M5]).

5 Operating basics

5.1 Display overview

The following displays the screen layout of R&S NGE100B. It shows the output voltage, current level and status bar information of the instrument.

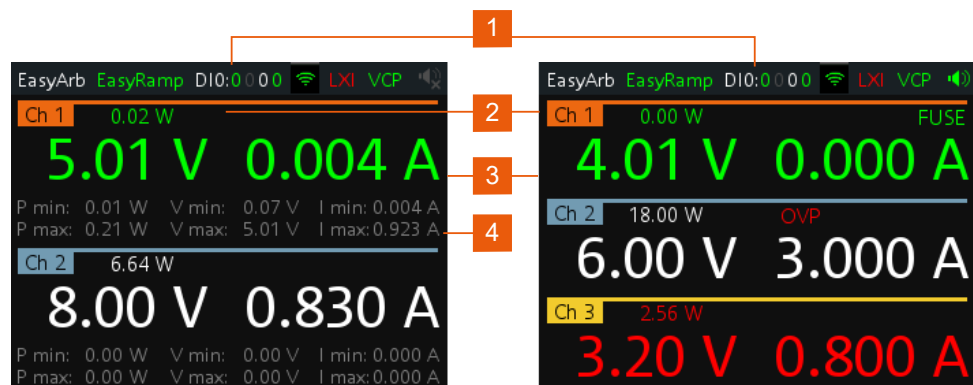

Figure 5-1: Screen layout of R&S NGE100B for two-channel and three-channel display

- 1 = Device status bar
- 2 = Channel status bar
- 3 = Channel display area
- 4 = Historical record information

5.1.1 Status bar information



There are two types of status bar. One shows device status information and the other shows the individual channel status information.

Device status bar



Table 5-1: Status bar function

Function	Description
EasyArb	Arbitrary output sequences on Ch 1. If in use, the icon is highlighted in green. If enabled, the icon is highlighted in white else it shows gray.
EasyRamp	Output voltage to ramp continuously within a 10 ms to 10 s until set voltage, V_{set} . If in use for any channel, the icon is highlighted in green else it shows gray.

Function	Description
DIO:xxxx	Digital Trigger I/O (Digital Trigger I/O option R&S NGE-K103 must be installed). The "xxxx" refers to I/O status for DIO1, DIO2, DIO3, DIO4. If in use, the icon is highlighted in green. If enabled, the icon is highlighted in white. If disabled or option not installed, the icon is highlighted in gray.
	Wireless LAN connection (WLAN option R&S NGE-K102 must be installed). Available only with instrument serial number below 110000. If connected to access point, the icon is highlighted in green. It shows yellow when connecting to access point. If disconnected or disabled, the icon is highlighted in gray.
LXI	Wired LAN connection with LXI service for remote control operation (Ethernet option R&S NGE-K101 must be installed). If in operation, the icon is highlighted in green If fault or option not installed, the icon is highlighted in gray
TMC/VCP	USB connection with USB-VCP or USB-TMC setting. If TMC or VCP is selected, the icon is highlighted in green.
	Indicate buzzer state ("Disabled", "Fault Events", "Any Events"). If speaker is enabled, the icon is highlighted in green, else it shows gray.

Channel status bar



Function	Description
Channel number	Channel number indication.
Power	Display output power in watt.
OVP / OPP / OTP	Indicator to show that the overload voltage, power or temperature protection is triggered. When triggered, the indicator shows flashing and displays in red.
Fuse	Indicator to show the fuse status (on or off). When triggered, the indicator shows flashing and displays in red.

5.1.2 Channel display area

Three channels are shown on the channel display area for NGE103B, and two for the NGE102B.

Historical record information

Available only in 2-channel instrument, the historical information at the bottom of the channel display area shows the maximum and minimum values for power ("W"), voltage ("V") and current ("A").

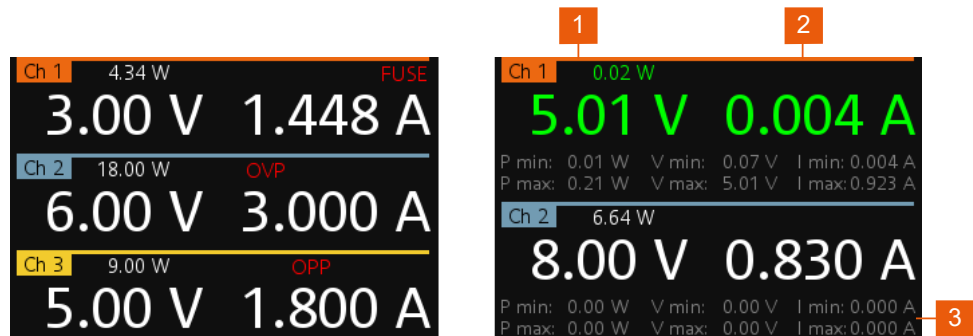

Figure 5-2: Channel display area for 3-channel and 2-channel instrument

- 1 = Output voltage displays in volt. The display resolution for voltage is two digits after the decimal point
- 2 = Output current displays in ampere. The display resolution for current is three digits after the decimal point
- 3 = [Historical record information](#) available only in 2-channel instrument.

Operating mode

Different font colors on the screen are used to differentiate the various output status and operating conditions of the instrument. It is easy to know and confirm the different output status and operating conditions of the instrument by looking at the colors.

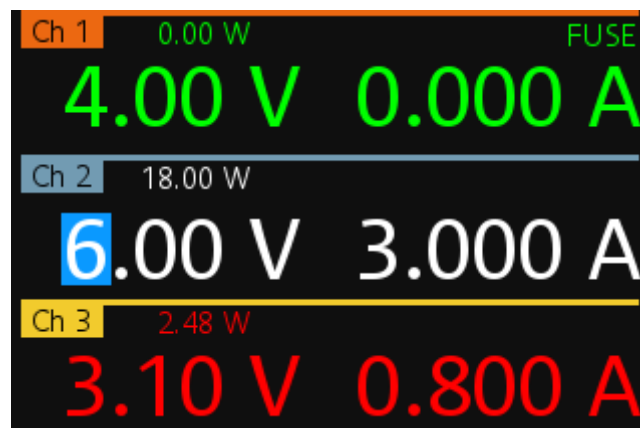

Figure 5-3: Color coding of difference operating conditions

Color	Operating mode	Description
□	OFF mode	Output is OFF
■	Editing mode	A solid blue cursor is shown when an item is selected. All cursor keys are also lit up.

Color	Operating mode	Description
■	CV mode	Active outputs are operated in a constant voltage mode.
■	CC mode	Active outputs are operated in a constant current mode.

5.2 Front panel keys

For an overview of the front panel keys, see [Figure 4-2](#).

5.2.1 Function keys

The following keys can be categorized based on their functions.

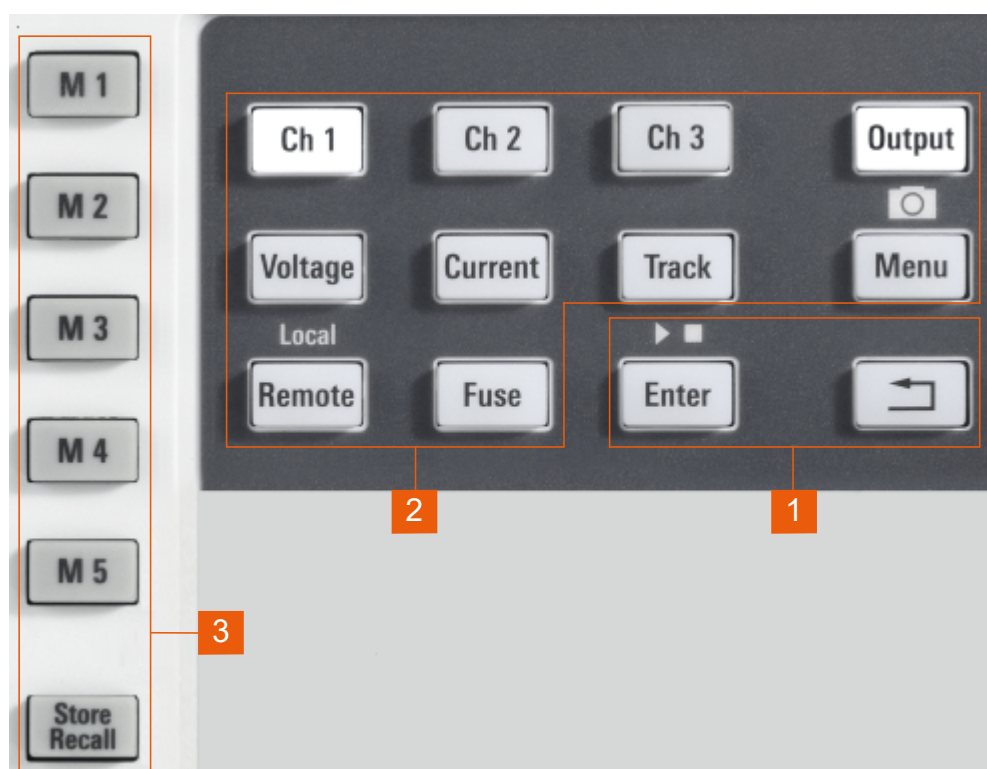

Figure 5-4: Function keys of R&S NGE100B

- 1 = Output and channel controls
- 2 = Navigation keys
- 3 = Instrument functions
- 4 = Memory functions



5.2.1.1 Output and channel controls



Function keys	Description
[Ch 1], [Ch 2], [Ch 3]	Selects the respective channel for output. See Chapter 6.1, "Setting the voltage and current" , on page 39.
[Output]	Master output switch - it turns output for all selected channels on or off. See Chapter 4.3.3, "Activating the channels output" , on page 26

5.2.1.2 Navigation keys

These keys provide navigation control in the instrument.

Function keys	Description
Enter 	Confirms menu selection or entry in dialog boxes. Start and stop (long press) the EasyArb function. See Chapter 6.7.1, "EasyArb" , on page 49.
Back 	Returns to the previous menu level or exit the menu mode. In menu dialog, press the [Back] key to discard changes and restore the previous value. In channel display area, press the [Back] key to exit editing mode and keep the changes made. In a 2-channel instrument, long press on the [Back] key resets the channel history information. See Figure 5-1 .

5.2.1.3 Instrument functions

These keys control the channel output settings and instrument functions.

Function keys	Description
Voltage	Sets the output voltage for the channel. See Chapter 6.1, "Setting the voltage and current" , on page 39.
Current	Sets the output current limit for the channel. See Chapter 6.1, "Setting the voltage and current" , on page 39.
Track	Configures the tracking function. See Chapter 6.4, "Tracking function" , on page 43.
Menu 	Main menu of the instrument. See Chapter 5.2.3, "Menu key" , on page 33. Long press on the [Menu] key to capture screenshot on the USB stick. The default screenshot filename starts with a prefix <code>nga100_scr_</code> followed by an ascending index 000-999 (e.g. <code>nga100_scr_001.bmp</code>).

Function keys	Description
Remote	Long press on the [Remote] key to switch from remote to local control mode.
Fuse	Toggles the fuse on/off. See Chapter 6.3.1, "Activating fuse" , on page 41.

5.2.1.4 Memory functions

These keys are dedicated for a specific preprogrammed function.

Function keys	Description
M1 to M5	Five memory keys to save or recall instrument settings.
Store Recall	Saves/loads instrument settings. See Chapter 6.8, "Store and recall" , on page 52.

5.2.2 Navigation controls

Navigation and value settings are done via the rotary knob and arrow keys.

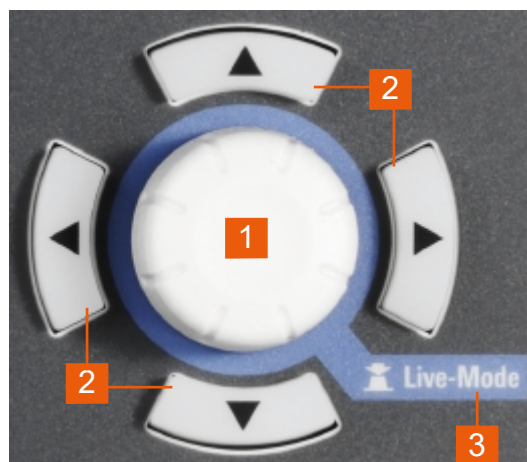

Figure 5-5: Navigation control

- 1 = Rotary knob
- 2 = Arrow keys
- 3 = Live-mode

5.2.2.1 Rotary knob



Step size changes of the numeric value correspond to the speed of the rotary knob.

The rotary knob has several functions depending on the mode it is in:

- Increments (clockwise direction) or decrements (counter-clockwise direction) any kind of numeric value when in editing mode.
- Navigates down (clockwise direction) or up (counterclockwise direction) the menu or menu items when rotated.
- Acts as an [Enter] key when pressed.
- Enter editing mode when pressed.
- Enter [live-mode](#) when long pressed.

5.2.2.2 Arrow keys

Using arrow keys, you can do several things:

- The up and down keys increase or decrease any kind of numeric value when in editing mode.
- Navigate through the menu or menu items in the dialog box.
- Long press on the up and down keys increase or decrease the numeric value of the menu items to maximum or minimum value when in editing mode. To stop the increasing or decreasing of value, press the rotary knob.
- The left and right keys move the cursor in an input field in the corresponding direction.

5.2.2.3 Live-mode

Long press on the rotary knob to go into the live-mode. When the instrument goes into the live-mode, all the arrow keys are illuminated.

The instrument automatically sets the Ch 1 voltage to editing mode. See [Figure 5-3](#). You can navigate to other channel settings by using the arrow keys to edit the voltage and current values.

The duration of live-mode depends on the [key fallback time](#). Set a longer fallback time if you need more time in this mode.

To exit live-mode, press the rotary knob.

5.2.3 Menu key

The R&S NGE100B [Menu] key provides access to instrument's functions and general instrumental settings. You can also obtain the instrument and service information via the [Menu] key.

Access:

1. Press [Menu] key on the front panel. The main menu screen appears.

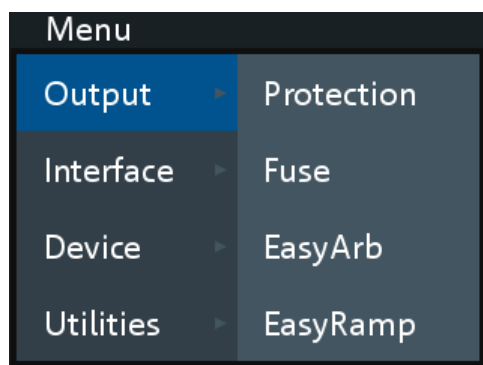

Figure 5-6: Main menu

2. Navigate the menu via the rotary knob or arrow keys.
3. Press the rotary knob or [Enter] key to enter the submenu.
4. Press  key to return to the previous menu level or exit the menu mode if it is already at the main menu level. Alternatively, press [Menu] key to exit the menu mode from any menu level.

Table 5-2: Main menu hierarchy

Menu	Descriptions
Output	Menu items related to the instrument's output functions.
Interface	Menu items related to connection setup.
Device	Menu items related to the instrument's general settings, reset function and information about the instrument.
Utilities	Menu items such as system test, firmware update function and information for service.

Table 5-3: Output menu hierarchy

Menu	Menu items	Descriptions
Output	Protection	Configures the OVP and OPP protection settings for the instrument. See Chapter 6.5, "Protection" , on page 44.
	Fuse	Configures the fuse delay and fuse linking function of the channel. See Chapter 6.3.2, "Fuse delay, fuse linking" , on page 42.
	EasyArb	Programs the waveform of the instrument voltage and current settings for Ch 1. See Chapter 6.7.1, "EasyArb" , on page 49.
	EasyRamp	Configures the ramping time of the voltage for selected channel. See Chapter 6.7.2, "EasyRamp" , on page 50.

Table 5-4: Interface menu hierarchy

Menu	Menu items	Descriptions
Interface	Ethernet	Configures the Ethernet interface. See Figure 6-15 . The Ethernet option R&S NGE100B-K101 must be installed for this function to be available in the instrument.
	WLAN	Configures the WLAN interface. See Figure 6-16 . The WLAN option R&S NGE100B-K102 must be installed for this function to be available in the instrument. Available only with instrument serial number below 110000.
	Digital IO	Configures the Digital Trigger I/O settings. See Figure 6-9 . The Digital Trigger I/O option R&S NGE100B-K103 must be installed for this function to be available in the instrument.
	USB	Configures the USB connection. See Figure 6-18 . Requires restart of the instrument to apply the setting.

Table 5-5: Device menu hierarchy

Menu	Menu items	Descriptions
Device	Information	Displays instrument information. See Chapter 6.10.1, "Instrument information" , on page 64.
	General	Configures general instrument settings. Chapter 6.10.2, "General instrument settings" , on page 65.
	License	Displays license information and install license options. See Chapter 6.10.3, "Managing options" , on page 65.
	Reset	Resets instrument to factory default settings. See Chapter 6.10.4, "Reset instrument" , on page 66.

Table 5-6: Utilities menu hierarchy

Menu	Menu items	Descriptions
Utilities	System Test	Provides self-test function for display screen, keypad back-light, beeper and fan. See Chapter 6.10.5, "System test" , on page 67.
	Update	Performs firmware update on the instrument. See Chapter 6.10.6, "Updating the firmware" , on page 68.
	Service	This function is restricted for service personnel only.
	Help	Provides help information for the instrument. See Chapter 6.10.7, "Help" , on page 69.





5.3 On-screen keyboard

The on-screen keyboard allows you to input symbols and alphanumeric characters in the input field. It can be invoked whenever there is an input field.



Figure 5-7: On-screen keyboard

Invoke the on-screen keyboard as follows:

1. Move the cursor to the desired input field.
2. Press [Enter] key. The on-screen keyboard appears.
3. Once on the keyboard screen, press the arrow keys or turn the rotary knob to go to the desired character.
4. Press the rotary knob to select the character.
 - Select  key if you want to create a space between characters.
 - To delete the last entered character, select the  key.
 - To delete the current entry, select the  key.
 - Select the  key to alternate between capital and small capital letters.
5. Repeat step 3 and 4 until all the characters are entered.
6. Select "OK" to confirm the input and exit the screen.
 - Select "ESC" or press [Menu] key to exit the screen without saving the changes.

5.4 Power derating

The NGE103B includes three identical channels with a continuous voltage range of 0 V to 32 V. The instrument provides a source of up to 3 A at 11.2 V and at 32 V it provides up to 1.05 A using the sophisticated power management.

Similar to NGE103B, the NGE102B provides an output power of 33.6 W for Ch 1 and Ch 2 respectively.

Combination of the set voltage and current limit results in the following output performance graph.

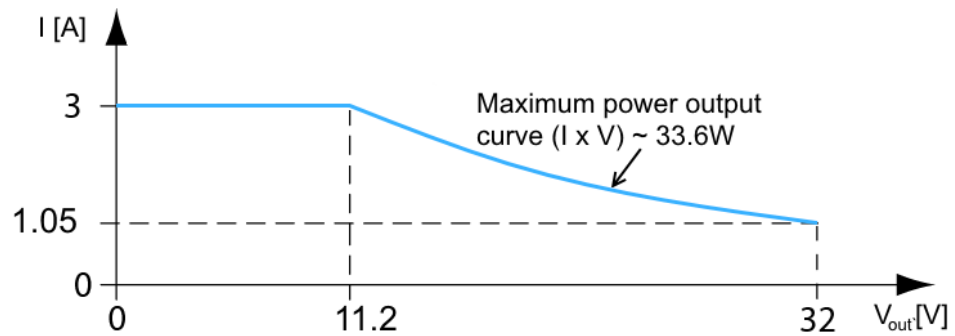

Figure 5-8: Output performance graph

According to the basic electrical formula for power ($P = I \times V$), the following results for the maximum power per channel:

- NGE102B: 33.6 W per channel (67 W max for the combination of two channels)
- NGE103B: 33.6 W per channel (100 W max for the combination of three channels)

For more information on the combination of channels, see [Chapter 9.1, "Parallel and series mode"](#), on page 105.

5.5 Operation modes

The R&S NGE100B operates in two different modes, i.e. CV and CC. The instrument switches automatically between CV and CC depending on the connected load.

CV mode

[Figure 5-9](#) shows that if the instrument is in the range of voltage regulation, the output voltage V_{out} remains constant while the current may increase to its maximum value I_{max} when the connected load is increasing. In CV mode, the font text in the channel display area changes to green.

See [Figure 5-3](#).

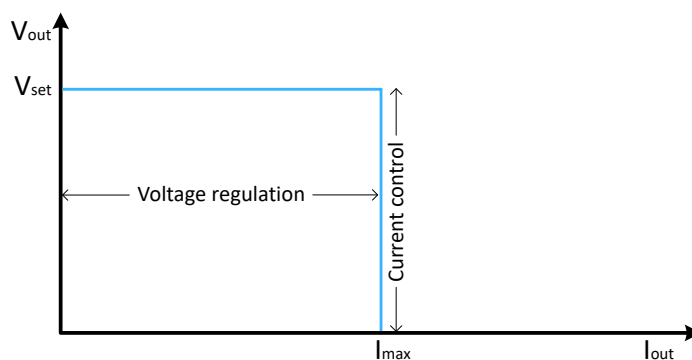

Figure 5-9: Current limit

CC mode

The current I_{max} corresponds to the current setting adjustable in the instrument.

If I_{out} reaches I_{max} , the instrument switches to CC mode, i.e. the output current remains constant and limited to I_{max} even if the load increases. Instead, the output voltage V_{out} decreases below V_{set} . In a short circuit, the output voltage drops towards zero. In CC mode, the font text in the channel display area changes to red.

See [Figure 5-3](#).

6 Instrument functions

6.1 Setting the voltage and current

The R&S NGE100B comes with the following instrument models:

Models	Channels
R&S NGE102B	Ch 1, Ch 2
R&S NGE103B	Ch 1, Ch 2, Ch 3

Toggle the respective channel key ([Ch 1], [Ch 2] or [Ch 3]) on the front panel to select these channels. When a channel is selected, the respective channel key illuminates. See [Figure 6-1](#).

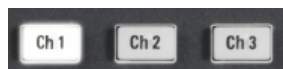

Figure 6-1: Ch 1 key illuminates when selected



Voltage, current settings

If "Arbitrary" function of a Ch 1 is enabled, the channel voltage or current setting is disabled. See ["EasyArb function"](#) on page 49.

The R&S NGE100B adjust voltage values between 0 V to 32.2 V with a step size of 0.01 V and current values between 0.003 A to 3.025 A with a step size of 0.001 A.

The setting of current value corresponds to the I_{\max} of the respective channel. It is advisable to set the current limit before operating the instrument to prevent damage to the load and instrument in the case of malfunction like short-circuit.

Access:

1. Press [Voltage] or [Current] key.
The previous set channel is selected.
The channel font changes to blue and all the navigation controls illuminate.
Selected [Voltage] or [Current] key and the channel key are also illuminated.
2. Press the desired channel key to switch to that channel.
Selected channel key ([Ch 1], [Ch 2], [Ch 3]) illuminates.
3. Enter the desired voltage or current value.
4. Press the rotary knob, [Voltage]/[Current] or [Enter] key to confirm the value.
The selected channel font text changes to yellow.
For more information on the operation modes, see [Chapter 5.5, "Operation modes"](#), on page 37.



Figure 6-2: Voltage and current settings in the instrument

See [Chapter 5.2.2.3, "Live-mode"](#), on page 33 for alternative way to configure the voltage and current values.

See also [General instrument settings](#) on the keypad for setting the fallback time.

6.2 Activating the channels output

Depending on the models, the outputs of the channels (Ch 1, Ch 2, Ch 3) can be switched on or off by toggling the [Output] key on the front panel.

By default, the output is turned off when the instrument is switched on. The output is also automatically turned off when no channel is selected. This design prevents a connected load from being damaged unintentionally.

Access:

1. Press the required channel key.
Selected channel key (Ch 1, Ch 2, Ch 3) illuminates.
2. Press [Output] key.
The R&S NGE100B outputs the set voltage of the selected channel.
Depending on the operating mode, the font text in the channel display area shows green in CV mode and red in CC mode.
See [Chapter 5.5, "Operation modes"](#), on page 37.
See also [Chapter 5.4, "Power derating"](#), on page 36.

Multiple outputs can be turned on or off at the same time. See more information in [Chapter 9, "Applications"](#), on page 105.



Figure 6-3: Output of Ch 3 in CV and CC mode

6.3 Electronic fuse

To protect a connected, sensitive output in general, the R&S NGE100B power supply includes an electronic fuse which can be switched on individually for each channel.

A fuse delay can be applied to each channel and individual electronic fuses can be logically linked to switch off the interlinked channels if a fuse triggers.

For more information, see [Chapter 6.3.2, "Fuse delay, fuse linking"](#), on page 42 for fuse delay and fuse linking configuration.

6.3.1 Activating fuse

The following shows the steps to activate the electronic fuse in the instrument.

Access:

1. Turn off the output before activating the fuse for each channel.
2. Press [Fuse] key.
The R&S NGE100B activates the fuse function and the [Fuse] key illuminates.
Activated fuses are illuminated on channel keys.
3. Press the desired channel to activate or deactivate the fuse.
Selected channel key ([Ch 1], [Ch 2], [Ch 3]) illuminates.
On the channel display area, the "FUSE" is indicated on selected channels.
4. Repeat step 1 and step 2 to disable the fuse function.

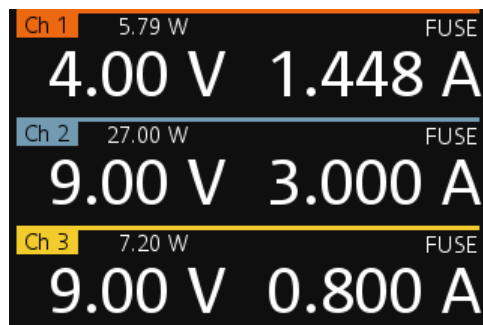

Figure 6-4: Fuse indicator on respective channel

6.3.2 Fuse delay, fuse linking

The fuse delay and fuse linking functions provide the flexibility to handle a fuse tripped event when it occurs. When a fuse tripped event triggered, the affected channels are turned off according to the settings configured in the fuse delay and fuse linking.

With fuse delay function, it allows you to ignore the current peaks set above the current limit that occurs during the time set in the fuse delay. This prevents the fuse to be triggered in case of a capacitive load.

With fuse linking function, it allows you to logically interlink channels with their electronic fuses. If a fuse trips during operation, all channels interlinked with this channel are turned off.

See [Chapter 6.3.1, "Activating fuse"](#), on page 41 for more information.

Access:

1. Press [Menu] key.
2. Select "Output" > "Fuse" menu item.
The R&S NGE100B displays the "Fuse" dialog. See [Figure 6-5](#).

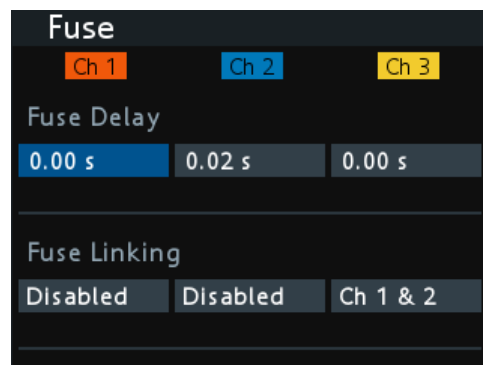

Figure 6-5: Fuse dialog

3. Set "Fuse Delay" to a desire value.
You can set a value from 0 s to 10 s in a 0.01 s step size.

4. Configure the "Fuse Linking" setting.

The R&S NGE100B provides the following options:

Example for "Ch 1", the available options are as follows:

- "Ch 2": "Ch 2" is linked to "Ch 1". If "Ch 1" fuse tripped, "Ch 2" is turned off.
- "Ch 3": "Ch 3" is linked to "Ch 1". If "Ch 1" fuse tripped, "Ch 3" is turned off.
- "Ch 2 & 3": "Ch 2" and "Ch 3" are linked to "Ch 1". If "Ch 1" fuse tripped, "Ch 2" and "Ch 3" are turned off.
- "Disabled": "Ch 1" is not linked to any other channels.

6.4 Tracking function

For power supplies with multiple channels, the channels can be linked such that changes made on the selected tracked channel are applied to other channel.

Example:

For example, the Ch 1 output supplies 6 V, intended for digital logic. The other two channels (Ch 2 & Ch 3) supply 20 V, which can be used with bipolar analog circuitry. The tracking adjustments are applied to the two 20 V supplies so that the + and - 20 V supplies can be adjusted together.

1. Press [Track] key.
The R&S NGE100B activates the tracking function and the [Track] key illuminates. Previous selected channel and [Voltage] keys are also illuminated.
2. Press the tracked channel to be tracked.
The selected tracked channel key ([Ch 1], [Ch 2] or [Ch 3]) illuminates.
3. Press [Current] key if current values should be tracked.
The selected channels are highlighted in blue and all the navigation controls illuminate.
Selected [Voltage] or [Current] key is also illuminated.
4. Set the desired voltage or current value.
Use the arrow keys or rotary knob to enter the value. All tracked channels voltage or current are changed by the same amount.

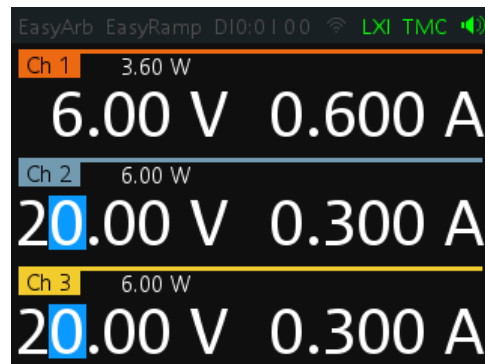

Figure 6-6: Tracking dialog

6.5 Protection

The R&S NGE100B provides individual overvoltage protection (OVP) and overpower protection (OPP) settings for each channel. With both function activated, the R&S NGE100B protects itself and the load in case of voltage or power overloads.

If protection is tripped, a red flashing OVP or OPP indicator is displayed on the respective channel. See [Figure 6-7](#).

A beep is sounded if buzzer is enabled. See [Figure 6-23](#).



Figure 6-7: Indicator of OVP/OPP when tripped

Access:

1. Press [Menu] key.
2. Select "Output" > "Protection" menu item.
The R&S NGE100B displays the "Protection" dialog. See [Figure 6-8](#).

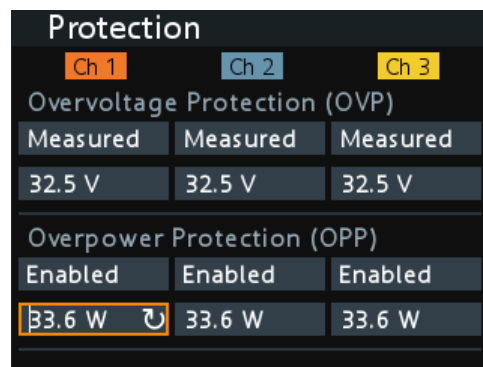

Figure 6-8: Protection dialog

- Set the OVP mode for the desired channel.
The available options are as follows:
 - "Measured": If the measured value exceeds the set limit, the output is switched off. Switching on the channels triggered the OVP if the condition remains.
 - "Protected": If the setting exceeds the set limit, the output is disabled.
 - "Disabled": OVP is set to maximum value supported by hardware. See the R&S NGE100B brochure for the instrument specification.
- Set the desired voltage for OVP.
You can set a value from 0 V to 32.5 V.
The R&S NGE100B turns off the respective channel when the measured voltage exceeded the preset value.
- Set the OPP mode for the desired channel.
The available options are as follows:
 - "Enabled": If the measured power exceeds OPP value, the channel is turned off.
 - "Disabled": Output power is limited to maximum value of 33.6W.
- Set the desired power for OPP.
You can set a value from 0 W to 33.6 W.
The R&S NGE100B turns off the respective channel when the measured power exceeded the preset value.

6.6 Digital trigger I/O

CAUTION

Digital I/O Pins Voltage Rating

Do not exceed the maximum voltage rating of the Digital I/O pins (5.25 V max) when supplying voltages to the pins.



R&S NGE-K103 (order number: 5601.2227.03) option is required for the Digital Trigger I/O.

The four data lines of the digital I/O interface are mutually independent and can be used as trigger input or trigger output separately. See [Figure 4-3](#).

- **Trigger input**
The data lines of the digital I/O interface receive external trigger signal. The external trigger signal triggers the selected channel (Ch 1, Ch 2, Ch 3) with the set response when the trigger condition (Active High or Active Low) is met.
- **Trigger output**
The data lines of the digital I/O interface output an "Active Low" or "Active High" signal when the trigger condition of the selected channel is met.

Table 6-1: Trigger in parameters and conditions

Trigger in parameters	Trigger conditions		Description
Channel	Ch 1, Ch 2, Ch 3		Target output channel selected for trigger response.
Response Trigger	Output On	Level	Selected channel [Output] is enabled when the selected logic level is met.
	Output Off	Level	Selected channel [Output] is disabled when the selected logic level is met.
	Output Toggle	Pulse	Selected channel [Output] is toggled when the selected logic pulse is met.
	Output Inhibit	Level	Selected channel [Output] is inhibited when the selected logic level is met. When the selected channel [Output] is put to inhibit state, manual or remote operation on selected channel [Output] is no longer possible. To reverse the inhibit state, remove the source of the trigger signal. You can either disable the affected DIO interface or remove the source from the affected DIO interface at the rear panel.
	Start EasyArb (Only for Ch 1)	Level	Activates the EasyArb function on channel 1 when the selected logic level is met. The EasyArb is deactivated when the level changes (i.e from active high to active low) See Chapter 6.7.1, "EasyArb" , on page 49.
Pulse		Activates the EasyArb function on channel 1 when the selected pulse is met. See Chapter 6.7.1, "EasyArb" , on page 49.	
Logic	Active High		Set the logic level of the trigger in signal.
	Active Low		

Table 6-2: Trigger out parameters and conditions

Trigger out parameters	Trigger conditions	Description	
Channel	Ch 1, Ch 2, Ch 3	Output channel selected to monitor for trigger condition.	
Condition Trigger	Output On	Output the selected logic level when the [Output] is turned on at the selected channel.	
	Output Off	Output the selected logic level when the [Output] is turned off at the selected channel.	
	Fuse Tripped	Output the selected logic level when a fuse tripped event occurs on the selected channel. See Chapter 6.3, "Electronic fuse" , on page 41.	
	CC Mode	Output the selected logic level when the selected channel operates in the CC mode. See "CC mode" on page 38.	
	Voltage Level	>= "set value" Output the selected logic level when the voltage level of the selected channel is greater or equal to the set level.	
	Current Level	>= "set value" Output the selected logic level when the current level of the selected channel is greater or equal to the set level.	
	Critical Event	OVP	Output the selected logic level when the selected critical event (OVP, OPP, OTP) occurs on the selected channel. See Chapter 6.5, "Protection" , on page 44.
		OPP	
OTP			
EasyArb Active		Output the selected logic level when the EasyArb function is running on channel 1. See Chapter 6.7.1, "EasyArb" , on page 49. Note: For a reliable DIO trigger output, the EasyArb waveform needs to be at least 200 ms.	
Logic	Active High	Set the logic level of the trigger out signal.	
	Active Low		



After a recall function, the "Master Enable" is disabled. See ["Recall instrument settings"](#) on page 53.



Enable the required DIO and "Master Enable" parameters to set up the Digital IO for usage.

Access:

1. Press [Menu] key.
2. Select "Interface" > "Digital IO" menu item.

The R&S NGE100B displays the "Digital IO" dialog. See [Figure 6-9](#).

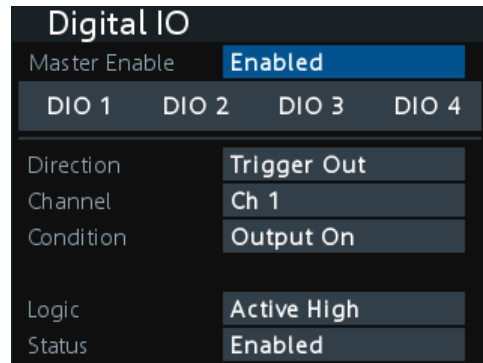

Figure 6-9: Digital IO dialog

3. Select the desired DIO interface for configuration.
4. Select "Trigger In" to accept external trigger signal or "Trigger Out" to output the trigger signal.
5. Set the desired "Channel".
6. Select the desired trigger condition.
See [Table 6-1](#) and [Table 6-2](#).
7. Set the desired "Logic" state.
8. Set the "Status" to "Enabled".
The R&S NGE100B enabled the selected DIO interface and monitor or feedback the trigger condition on the selected channel.
9. Set the "Master Enable" to "Enabled".
The "Master Enable" is the master DIO interface which activates or deactivates all the DIO interfaces.

6.7 Advanced functions

The following chapters provide information about the [EasyArb](#) and [EasyRamp](#) menu items found in the [Menu] key.

Access:

1. Press [Menu] key.
2. Select the "Output" menu item.
The R&S NGE100B displays the respective menu item dialog.

6.7.1 EasyArb



EasyArb function

The arbitrary function is available only in Ch 1.
See "[Voltage, current settings](#)" on page 39.



LabVIEW driver

The arbitrary functions in LabVIEW driver rshmc804x do not support the EasyArb feature in the R&S NGE100B.

The R&S NGE100B series allows you to generate freely programmable waveforms which can be reproduced within the limits set by the instrument for voltage and current.

1. Select "EasyArb" menu item.

The R&S NGE100B displays the "EasyArb" dialog. See [Figure 6-10](#).

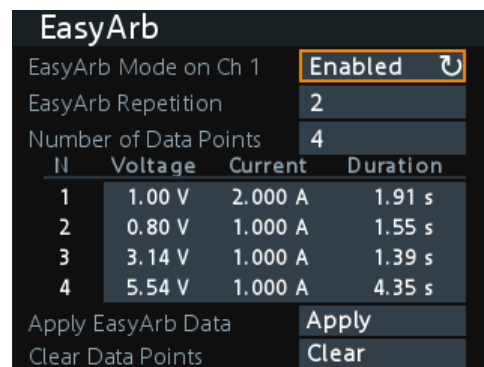

Figure 6-10: EasyArb dialog

2. Set "EasyArb Mode on Ch 1" to "Enabled".
The R&S NGE100B enabled the EasyArb function for Ch 1.
Note: If "EasyArb Mode" is set disabled, corresponding output state of Ch 1 is also disabled.
3. Set the desired repetition cycle for the EasyArb function.
4. Set the desired data points for the EasyArb function.
The R&S NGE100B displays the number of EasyArb entry points in the EasyArb table.
5. Configure the EasyArb table with the desired values for voltage, current and duration.
6. Select "Apply" to save the EasyArb settings.
The EasyArb data points are sent to Ch 1.
7. Select "Clear" to reset the EasyArb table values.
All the EasyArb data points are cleared from Ch 1.

8. Press [Menu] key to return to the [Channel display area](#).
The [Enter] key is illuminated.
9. Press [Output] key to enable the R&S NGE100B output.
10. Press [Enter] key to start the EasyArb function.
11. Long press on the [Enter] key to stop the EasyArb function.

Table 6-3: EasyArb input field

EasyArb input field	Description
EasyArb mode	Enable or disable the EasyArb function. If enabled, the EasyArb function is activated in Ch 1. See "EasyArb function" on page 49.
Data points	Set the number of data points in the EasyArb table. Each data point contains the settings for "Voltage", "Current" and "Duration".
Repetition	Set the number of times the waveform is output in the EasyArb table. If this is set to "0", the waveform is output continuously.
EasyArb table	Configures the EasyArb data table. Use the arrow keys to navigate the "Voltage", "Current" and "Duration" settings.
Clear	Reset all the data points in the EasyArb table to 0.00 V, 1.000 A and 0.01 s for "Voltage", "Current" and "Duration" respectively.
Apply	Select "Apply" to save EasyArb configuration.

6.7.2 EasyRamp

With EasyRamp, the R&S NGE100B provides you the operating condition to output a constant rise of the supply voltage. The output voltage can be increased continuously within a 10 ms to 10 s timeframe. See [Figure 6-11](#).

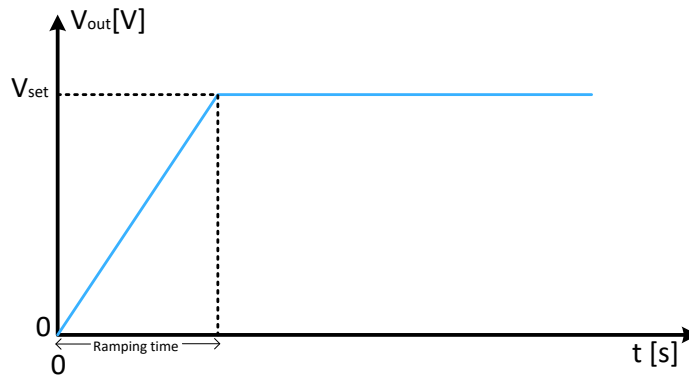

Figure 6-11: Ramping voltage output

1. Select "EasyRamp" menu item.
The R&S NGE100B displays the "EasyRamp" dialog. See [Figure 6-12](#).

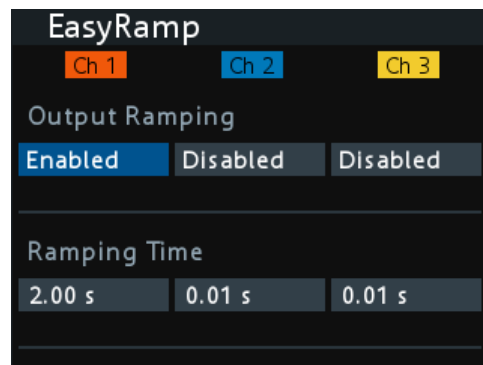

Figure 6-12: EasyRamp dialog

2. Select the desired channel.
3. Set the selected channel to "Enabled".
The R&S NGE100B enabled the EasyRamp function for the selected channel.
Note: If selected channel is set disabled, corresponding output state of the selected channel is also disabled.
4. Set the "Ramping Time" of the selected channel.
5. Press [Enter] key to confirm the settings.

Table 6-4: EasyRamp input field

EasyRamp input field	Description
"Output Ramping"	Enable or disable the EasyRamp function individually for each channel.
"Ramping Time"	Duration taken for the voltage to rise to V_{set} .

6.8 Store and recall



The [Store Recall] function is disabled when the instrument is in editing mode. See [Figure 5-3](#).



Upon power-up, the instrument loads the stored settings from memory location M1 with the exception on EasyArb parameters. Auto saved parameters are also applied during startup.

The R&S NGE100B output state of all channels (Ch 1, Ch 2, Ch 3) is disabled when the recall function is activated.



Auto save instrument settings

Auto save of instrument settings are applied when any of the following parameters changed:

- [General instrument settings](#)
- [USB connection mode](#)
- [WLAN settings](#) (only with instrument serial number below 110000)
 - "Module"
 - "SSID"
 - "Password"
- [Ethernet settings](#)

The instrument settings can be stored or recalled from memory locations M1 to M5.

The following instrument settings are stored or recalled in the memory location:

- [Fuse settings](#)
- [Protection settings](#)
- [EasyRamp settings](#)
- [Set voltage and current levels](#)
- ¹[EasyArb settings](#)
- ¹[Digital IO settings](#)

¹The EasyArb or DIO settings can only be saved in the respective dialog environment and all other above instrument settings are not saved when a store function is made. Similarly, when a recall function is made on the same-stored memory location, only the EasyArb or DIO settings are recalled.

Store instrument settings

Access:

1. Long press [Store Recall] key to store instrument settings.

The R&S NGE100B displays a message "Store device settings: select any [Mx] key" in the status bar.

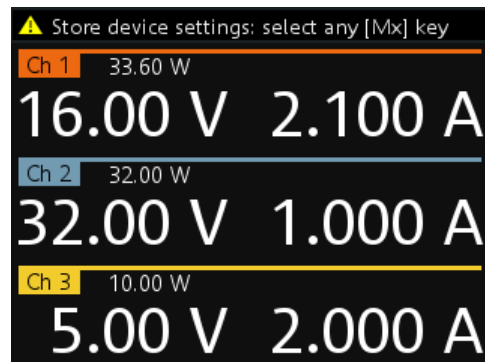

Figure 6-13: Store instrument settings

- Press any of the memory keys ([M1], [M2], [M3], [M4], [M5]) to store the instrument settings.
The R&S NGE100B stores the instruments settings in the selected memory location.

Recall instrument settings

Access:

- Press [Store Recall] key to recall instrument settings.
The R&S NGE100B displays a message "Recall device settings: select any [Mx] key" in the status bar.

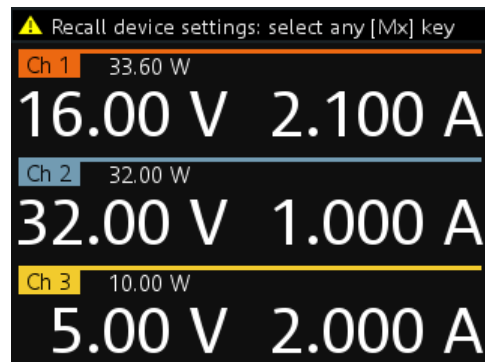

Figure 6-14: Recall instrument settings

- Press any of the memory keys ([M1], [M2], [M3], [M4], [M5]) to recall the instrument settings.
The R&S NGE100B recalls the instruments settings from the selected memory location.

6.9 Interfaces and protocols

There are various of ways how the R&S NGE100B can be remotely accessed and controlled.

Access:

1. Press [Menu] key.
2. Select "Interface" menu item to configure the required interface.
The R&S NGE100B displays the available interface options.

6.9.1 Network connection

To establish a local area network (LAN) connection with the R&S NGE100B for remote control operation.

- [LAN](#)
- [Wireless LAN](#)

6.9.1.1 LAN connection



Instrument option

R&S NGL-K101 (P/N: 5601.2204.03) option is required to connect the R&S NGE100B to a network via LAN connection.

The R&S NGE100B is equipped with a network interface and can be connected to an Ethernet LAN (local area network). A LAN connection is necessary for remote control of the instrument, and for access from a computer using a web browser.

NOTICE

Risk of network failure

Before connecting the instrument to the network or configuring the network, consult your network administrator. Errors may affect the entire network.



To establish a network connection, connect a commercial RJ-45 cable to the LAN port of the instrument and to a PC or network switch.

Depending on the network capacities, the TCP/IP address information for the instrument can be obtained in different ways.

- If the network supports dynamic TCP/IP configuration using the Dynamic Host Configuration Protocol (DHCP), and a DHCP server is available, all address information can be assigned automatically.

- Otherwise, the address must be set manually. Automatic Private IP Addressing (APIPA) is not supported.

By default, the instrument is configured to use dynamic TCP/IP configuration and obtain all address information automatically. This means that it is safe to establish a physical connection to the LAN without any previous instrument configuration.

NOTICE

Risk of network errors

Connection errors can affect the entire network. If your network does not support DHCP, or if you choose to disable dynamic TCP/IP configuration, you must assign valid address information before connecting the instrument to the LAN. Contact your network administrator to obtain a valid IP address.

Access:

1. Connect a LAN cable to the [LAN port](#).
2. Configure the connection settings manually or have the network configure the settings for you via menu. By default, automatic configuration is set in the instrument. For manual configuration, select "Ethernet" menu item
The R&S NGE100B displays the "Ethernet" dialog.

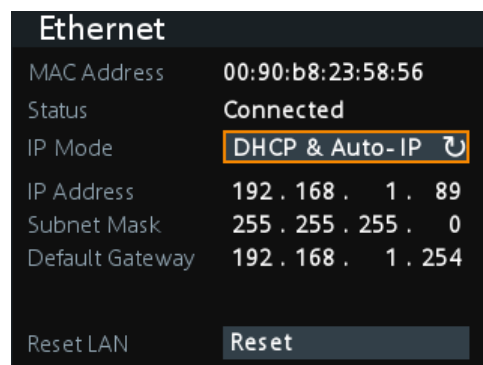

Figure 6-15: Ethernet dialog

3. Select "DHCP & Auto-IP" for "IP Mode".
4. Enter the "IP Address".
5. Enter the "Subnet Mask".
6. Enter the "Default Gateway".
7. Select "Apply" to complete the configuration.
8. Press [Menu] key to exit the dialog.

Table 6-5: Ethernet input field

Ethernet input field	Description
"MAC Address"	Shows the MAC address of this instrument.
"Status"	Shows if the connection is up or down.
"IP Mode"	"Static & Manual": Manually configure an IP address for the instrument. "DHCP & Auto-IP": Automatically assign an IP address to the instrument.
"IP Address"	Address used in communication with the network. Manually configure this field if IP mode set to "Static & Manual".
"Subnet Mask"	Secondary address used in communication with the network. Manually configure this field if IP mode set to "Static & Manual".
"Default Gateway"	Gateway address to connect to the network. Manually configure this field if IP mode set to "Static & Manual".
"Reset LAN"	Restores the LAN settings to factory default. It also removes the LXI web password.
"Apply"	Apply static IP settings.

6.9.1.2 Wireless LAN connection

WARNING

Risk of RF exposure

When WLAN is active, a minimum separation distance of 20 cm from front panel of the instrument must be observed at all times.

When WLAN is active, no operation of antenna or transmitter should be co-located with the instrument.



Wi-Fi transmitter performance

Frequency range: 2412 MHz to 2484 MHz

Power: 19.5 dBm typical



Instrument option

R&S NGE-K102 (order number: 5601.2210.03) option is required to connect the R&S NGE100B to a network via WLAN connection.

Wireless LAN option is only available for instrument with serial number below 110000.



WLAN connection

The LAN connection has a higher priority over WLAN.

If LAN is connected, the WLAN connection will be disconnected. When LAN is disconnected, WLAN reconnects automatically.

An alternative to connection in local area network is wireless LAN connection. With the presence of an authenticated Wi-Fi signal, the R&S NGE100B automatically connects to a network and navigation can be made via the web browser according to the WLAN IEEE 802.11 b/g/n standards.

1. Select "WLAN" menu item.
The R&S NGE100B displays the "WLAN" dialog.

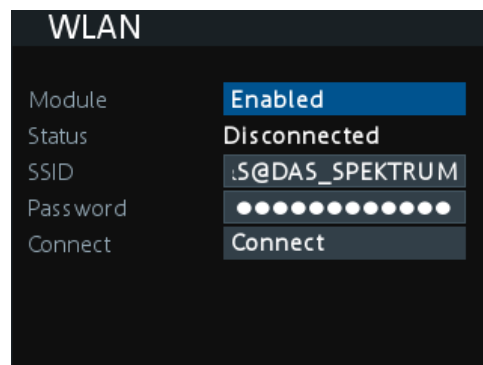

Figure 6-16: WLAN dialog

2. Select "Enabled" for "Module".
3. Set the "SSID"
SSID - Service Set Identifier, a unique ID used for naming wireless network.
4. Set the associated password for the "SSID".
5. Select the "Connect" button.
If connection is successful, the "Status" shows "Connected". See [Figure 6-17](#).
When the connection is alive, the WLAN icon turns green on the status bar. See ["Device status bar"](#) on page 27.

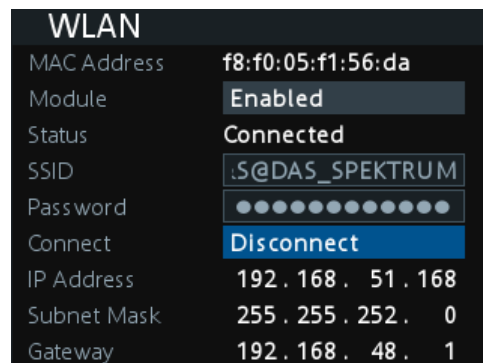

Figure 6-17: WLAN connected

- To disconnect, select "Disconnect" in the WLAN dialog.

6.9.2 USB connection



Change of USB class

If a change in "USB Class" is detected (i.e. from "TMC" to "VCP" or vice versa), the rebooting of instrument is necessary to load the correct USB driver.

Alternatively, connect a USB cable to the **USB port** and PC for a USB connection. The R&S NGE100B supports "USB TMC" and "USB VCP" connection.

Access:

- Select "USB" menu item.
The R&S NGE100B displays the "USB" dialog.

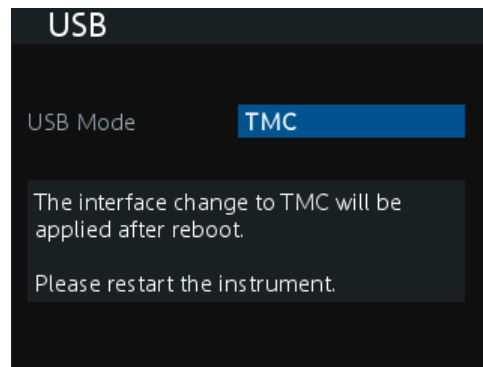

Figure 6-18: USB dialog

- Set the desired "USB Mode".
 - "VCP": USB virtual COM port
 - "TMC": USB Test & Measurement class
- Press [Enter] key to confirm the settings.
The R&S NGE100B displays message to prompt the user to restart the instrument to apply the changes.
- Restart the R&S NGE100B to apply changes.

USB VCP



The following requirements for USB-VCP driver installation are necessary:

- A PC with operating system Windows XP, VISTA, Windows 7 or Windows 8 (32Bit or 64Bit).
- Administrator rights are necessary for the installation of the driver.

The USB virtual COM port (USB-VCP) is a software interface that allows the communication to the R&S NGE100B using any terminal program (e.g. HMExplorer) via SCPI commands once the corresponding Windows drivers have been installed. The actual USB-VCP driver and software HMExplorer can be downloaded for free from the product homepage (<http://www.rohde-schwarz.com/product/nge100b>).

If a connection between PC and the instrument has been established and no R&S NGE100B USB-VCP driver is installed, the PC operating system displays a "Found New Hardware" wizard. In this case, the R&S NGE100B USB-VCP driver must be installed.

The HMExplorer window application provides the R&S NGE100B a terminal function and also the option to create screenshots and editor function to create the EasyArb table.

For more information of the driver installation and HMExplorer window application, see the installation guide of the driver file and the internal HMExplorer help.

USB TMC

The USB Test & Measurement class (USB-TMC) is a protocol that allows GPIB-like communication via USB interfaces and is a separate instrument class of the USB specification. The USB-TMC protocol supports service queries, triggers, and other GPIB-specific instructions.

VISA drivers are installed and that it can be used directly in the corresponding environments. The driver is included in the NI-VISA package and can be downloaded at <http://www.ni.com/downloads/ni-drivers/>.

A major benefit of the USB TMC class is that by sampling specific registers, the controlling software can determine if commands have been terminated and if they have been processed correctly. With USB-VCP, communication with instrument requires analysis and polling mechanisms within the controlling software which may significantly strain the interface of the measurement instruments. The TMC status registers solve this problem with the USB TMC in the same manner as in the case with the GPIB interface for the hardware via the corresponding control lines.



HMExplorer

The window application supports the communication via LAN, USB VCP and WLAN only.

For more information of the VISA driver installation, see the installation guide of the VISA driver file.

Once the driver is installed, the "USB Test and Measurement Device (IVI)" is displayed in the "Device Manager" window, see [Figure 6-19](#).

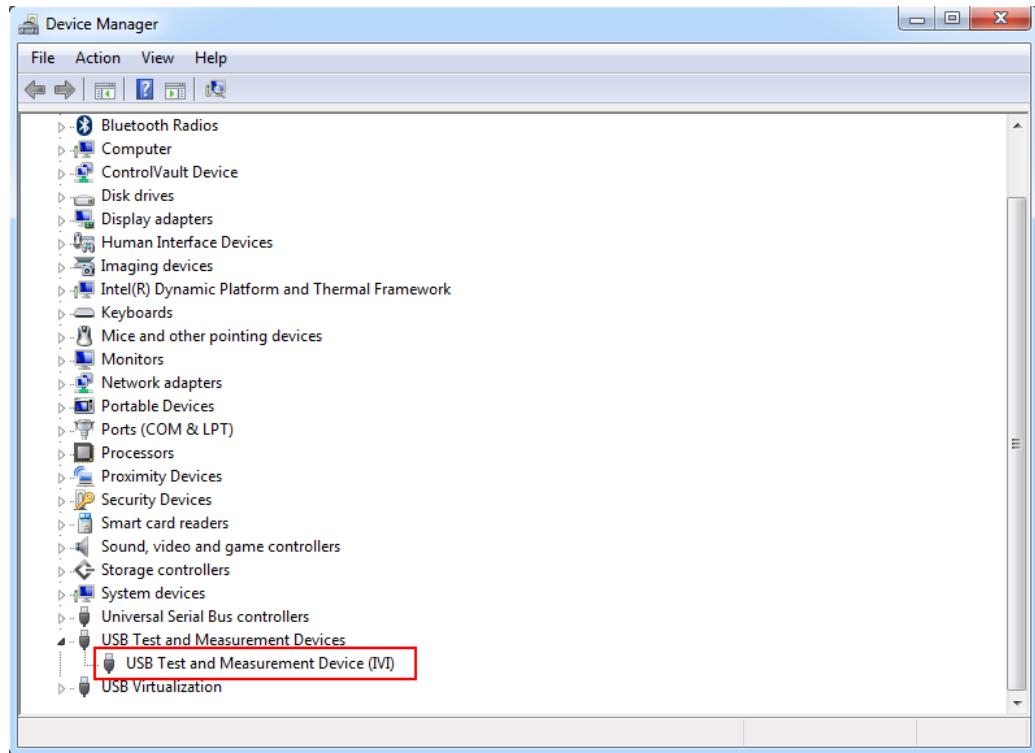

Figure 6-19: Device manager

6.9.3 LXI

LAN extension for instrumentation (LXI) is a platform for measuring devices and test systems based on standard Ethernet technology. LXI is to be the LAN-based successor to GPIB and combine the advantages of Ethernet with the simple and familiar features of the GPIB. This standard provides a new standard for network configuration of front panel devices via a WEB interface. The central tool for this type of configuration is a browser.

LXI-compatible devices are divided into three classes, A, B and C, where the functionality of the classes is based on each other hierarchically:

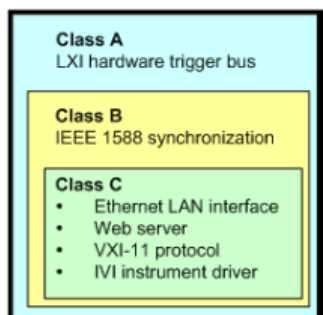

Figure 6-20: LXI classes

- Class C devices are characterized by a uniform LAN implementation including an ICMP ping responder for diagnostic purposes. Devices can be configured with a WEB browser.
A LAN Configuration Initialize (LCI) mechanism resets the LAN configuration. Class C LXI devices are also intended to support automatic detection in a LAN via VXI-11 discovery protocol and programming using IVI drivers.
- Class B adds the IEEE 1588 Precision Time Protocol (PTP) and peer-to-peer communication to base class C. With IEEE 1588, all devices within a network can automatically synchronize to the most accurate available clock, and then provide time-stamps or synchronization signals for all devices with exceptional accuracy.
- Class A devices also contain the eight-channel hardware trigger bus (LVDS interface) according to the LXI standard.

Class A and B devices can send and receive software triggers through LAN messages and communicate with each other without using the controller.

The power supplies of the R&S NGE100B series meet the general requirements of the LXI Class C and correspond to the version 1.5 (LXI Core 2016). Advanced features are not supported.

A key component of an LXI certification is the IVI device driver (Interchangeable Virtual Instrument). Here IVI.NET drivers are provided, which are based on the .NET framework 4 of Microsoft. LabView and LabWindows/CVI drivers built on LabWindows/CVI 2012 are also available. The latest copy of the IVI.NET driver is available for download from the product homepage <http://www.rohde-schwarz.com/product/nge100b>.

In addition to the features described above, the device provides the following LXI-related functions:

- Displays the current device settings
- Remote control of the device within the WEB-Browser

The Ethernet interface has an integrated web server, you can access the instrument with its corresponding IP address in the address line of the browser (i.e. <http://172.25.57.65>). See [Figure 6-21](#).

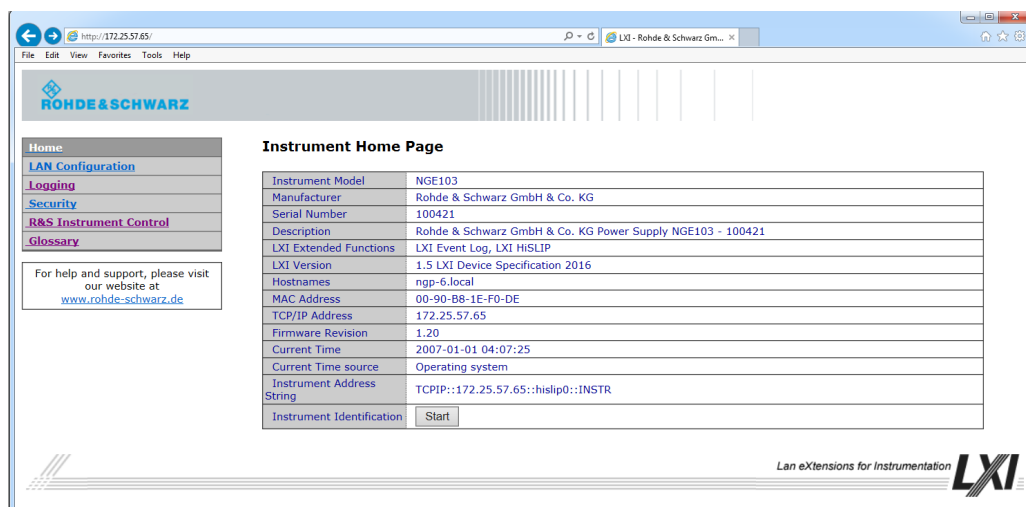

Figure 6-21: Instrument web browser view

6.9.4 SCPI

SCPI (Standard Commands for Programmable Instruments) commands - messages - are used for remote control. Commands that are not taken from the SCPI standard follow the SCPI syntax rules. The instrument supports the SCPI version 1999. The SCPI standard is based on standard IEEE 488.2 and aims at the standardization of device-specific commands, error handling and the status registers. The tutorial "Automatic Measurement Control" - A tutorial on SCPI and IEEE 488.2" from John M. Pieper (R&S order number 0002.3536.00) offers detailed information on concepts and definitions of SCPI.

The requirements that the SCPI standard places on command syntax, error handling and configuration of the status registers are explained in detail in the following sections. For more information, see [Chapter 7, "Remote control commands"](#), on page 70 and [Chapter A, "Additional basics on remote control"](#), on page 108.

6.9.5 VISA

VISA is a standardized software interface library providing input and output functions to communicate with instruments. The I/O channel (LAN or USB) is selected at initialization time by means of a channel-specific resource string. For more information about VISA, refer to its user documentation.

6.9.6 Setting up remote control connection

USB

The following shows the resource string format used when setting up a remote connection via the USB interface:

- **USB TMC**
`USB0::0x0AAD::`
`0x0197::5601.1414<device_variant>-<device_serial_number>::`
`INSTR` where `k03` is used for 3-ch device, `k02` for 2-ch device. (e.g.
`USB0::0x0AAD::0x0197::5601.1414k03-100689::INSTR`)
- **USB VCP**
`ASRL<COM>::INSTR`, where "COM" refers to the COM port number shown on the
controlling PC. (e.g. `ASRL15::INSTR`)

LAN/WLAN

See [Chapter 6.9.1, "Network connection"](#), on page 54 for configuring the LAN and WLAN parameters.

To set up the connection the IP address of the instrument is required. It is part of the resource string used by the program to identify and control the instrument. The resource string has the form:

```
TCPIP::<IP_address>::INST
```

Example: If the instrument has the IP address 192.1.2.3; the valid resource string is:

```
TCPIP::192.1.2.3::INST
```

High-Speed LAN Instrument Protocol (HiSLIP) is a TCP/IP-based protocol for remote instrument control of LAN-based test and measurement instruments. It was specified by the IVI Foundation and is intended to replace the older VXI-11 protocol. To start remote control session with HiSLIP, the valid resource string is:

```
TCPIP::192.1.2.3::HISLIP
```



The end character must be set to line feed (LF).

[Remote] key

Access:

1. Press [Remote] key to unlock the instrument from the remote control mode. In the remotes mode, all front panel keys on the instrument are disabled and the [Remote] key is illuminated.
2. To switch back to the local mode, press [Remote] key to release the remote control mode.

6.10 General instrument settings

The following chapters provide the general instrument information and utilities services in R&S NGE100B.

Access:

1. Press [Menu] key.
2. Select "Device" menu item to configure the required instrument settings.
3. Select "Utilities" menu item to configure the utilities services.

6.10.1 Instrument information

The "Information" dialog provides the general instrument information of R&S NGE100B.

- ▶ Select "Information" menu item.
The R&S NGE100B displays the "Information" dialog. See [Figure 6-22](#).

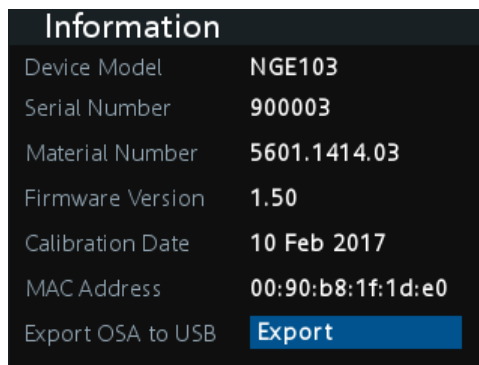

Figure 6-22: Information dialog

Device information	Description
"Device Model"	Model of the instrument, i.e. NGE102B or NGE103B.
"Serial Number"	Unique identification number for the instrument.
"Material Number"	Instrument orderable part number.
"Firmware Version"	Software version that is installed in the instrument.
"Calibration Date"	The last registered date when calibration was carried out on the instrument.
"MAC Address"	MAC address of the network interface.
"Export OSA to USB"	The open-source acknowledgment (OSA) of the R&S NGE100B can be exported to USB stick for reference.

6.10.2 General instrument settings

General instrument settings such as keypad fallback time, screen display brightness and buzzer setting are provided.

Access:

- ▶ Select "General" menu item.
The R&S NGE100B displays the "General" dialog. See [Figure 6-23](#).

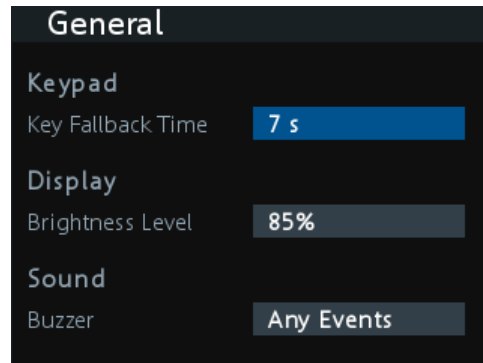

Figure 6-23: General dialog

General instrument settings	Description
Keypad	Selects the wait time before the instrument automatically leaves the editing mode. Select "Off" to disable the automatic switching back.
Display	Selects the specific screen intensity to control the screen brightness. Setting is applied immediately.
Sound	Selects the event where sound is generated. <ul style="list-style-type: none"> • "Fault Events": Sounds on faulty events only • "Any Events": Sounds on faulty events and key press events • "Disabled": No sound is generated

6.10.3 Managing options

Options are enabled by entering a registered license key code.

You may choose to install from an XML file on USB or by manually entering the key code.

- ▶ Select "License" menu item.
The R&S NGE100B displays the "License" dialog. See [Figure 6-24](#).

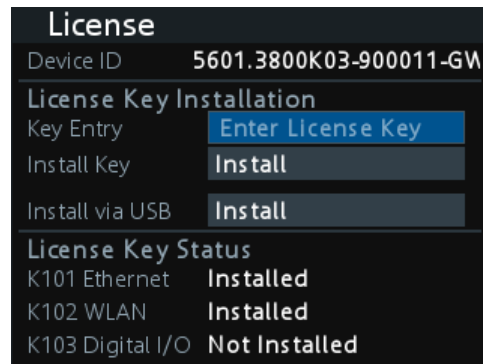

Figure 6-24: License dialog

Install via USB

To install from an XML file, proceed as follows:

1. Copy the XML file containing the registered key code into the USB flash drive.
2. Connect the USB flash drive to the USB port of the instrument.
3. Select "Install via USB" > "Install".
If the installation is successful, the option is marked as "Installed" under "Installation Status".

Install via key entry

To manually enter the key code, proceed as follows:

1. Press [Enter] key to invoke the [On-screen keyboard](#).
2. Enter the key code (30-digit number) of the option in the entry box.
3. Select "Install key" > "Install".
If the correct key code is entered, the option is marked as "Installed".
If an invalid key code is entered, an error message is displayed. Re-enter the correct key code.

6.10.4 Reset instrument

This function resets the instrument to factory default settings.

The following settings are reset to default:

- ▶ Select "Reset" menu item.
The R&S NGE100B displays the "Reset" dialog. See [Figure 6-25](#).

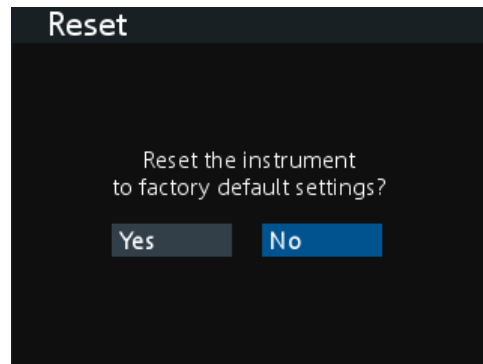

Figure 6-25: Reset dialog

6.10.5 System test

This function provides a system test to check the instrument working conditions for screen color display, key backlight, beeper and cooling fan.

Access:

- ▶ Select "System Test" menu item.
The R&S NGE100B displays the "System Test" dialog. See [Figure 6-26](#).

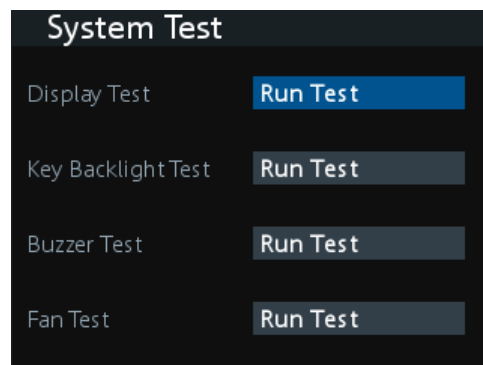

Figure 6-26: System test dialog

System test	Description
"Display Test"	Test that the display is working. RGB and a list of supported colors should appear on the screen during the test.
"Key Backlight Test"	Test that the key backlight is working. During the test, all keys on the front panel illuminate except ([M1], [M2], [M3], [M4], [M5]) and [Store Recall].

System test	Description
"Beeper Test"	Test that the instrument sound is working. Three beep sounds should be heard during the test.
" Fan Test"	Test that the cooling fan is working.

6.10.6 Updating the firmware

The latest firmware file can be found from the product homepage <http://www.rohde-schwarz.com/product/nge100b>.

For firmware update using SCPI command, see "Firmware update via SCPI command for version 1.3 and above" on page 69.



Do not power off or operate the instrument during a firmware update.

Do not rename the firmware filename `NGE100FWRelease.tar.gz.enc` and `NGE100FWRelease.fwp`.

1. Download the firmware file from the product homepage.
2. Unzip the firmware to the root directory of a USB flash drive.
There are two files after unzipping the firmware file, do not rename these files.
3. Connect the USB flash drive to the USB port of the instrument and wait for ten seconds.
4. Press [Menu] key.
5. Select "Utilities" > "Update" menu item.
If firmware file is found, the R&S NGE100B displays the "Update" dialog. See [Figure 6-27](#).

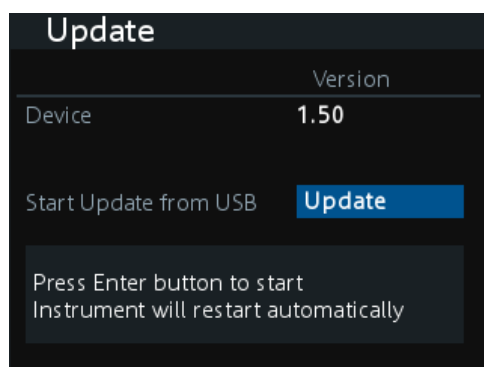

Figure 6-27: Update dialog

6. Press [Enter] key to start firmware update process.
The R&S NGE100B reboots automatically as part of the update process.
7. Press [Enter] key to confirm the update when prompt.

8. Alternatively, you can press [Back] key to cancel the firmware update process.
9. Wait for the completion of the update process.
It takes a few minutes to complete the firmware update process.

Firmware update via SCPI command for version 1.3 and above

1. Download the firmware file from the product homepage.
2. Unzip the firmware to the root directory of a USB flash drive.
There are two files after unzipping the firmware file, do not rename these files.
3. Connect the USB flash drive to the USB port of the instrument and wait for ten seconds.
4. Connect to the instrument via [USB](#), [LAN](#) or [WLAN](#).
5. Send `DIAGnostic:SERvice:FWUP "NGE100FWRelease.tar.gz.enc"` to start firmware update remotely.
The R&S NGE100B reboots automatically as part of the update process.
6. Wait for the completion of the update process.
It takes a few minutes to complete the firmware update process.

6.10.7 Help

The "Help" dialog provides the internet link and QR code for the latest R&S NGE100B information.

1. Select "Help" menu item.
The R&S NGE100B displays the "Help" dialog. See [Figure 6-28](#).



Figure 6-28: Help dialog

2. Use a QR code reader to scan the QR code to link to the online product home page.
Alternatively, you could enter the address: <http://www.rohde-schwarz.com/product/nge100b> into a browser to access the latest help information.

7 Remote control commands

This chapter provides the description of all remote commands available for the R&S NGE100B series. The commands are sorted according to the menu structure of the instrument. A list of commands in alphabetical order is given in the "List of Command"s at the end of this documentation.

For more information on [Messages and command structure](#), see the "Annex" at the end of this documentation.

7.1 Common setting commands

Common commands are described in the IEEE 488.2 (IEC 625-2) standard. These commands have the same effect and are employed in the same way on different devices. The headers of these commands consist of "*" followed by three letters.

Many common commands are related to the Status Reporting System.

*CLS.....	70
*ESE.....	70
*ESR?.....	71
*IDN?.....	71
*OPC.....	71
*OPT?.....	71
*RST.....	71
*SRE.....	72
*STB?.....	72
*TST?.....	72
*WAI.....	72
*SAV.....	72
*RCL.....	73

*CLS

Clear status

Sets the status byte (STB), the standard event register (ESR) and the `EVENT` part of the `QUESTIONABLE` and the `OPERATION` registers to zero. The command does not alter the mask and transition parts of the registers. It clears the output buffer.

Usage: Setting only

*ESE <Value>

Event status enable

Sets the event status enable register to the specified value. The query returns the contents of the event status enable register in decimal form.

Parameters:

<Value> Range: 0 to 255

***ESR?**

Event status read

Returns the contents of the event status register in decimal form and then sets the register to zero.

Return values:

<Contents> Range: 0 to 255

Usage: Query only

***IDN?**

Identification

Returns the instrument identification.

Return values:

<ID> "Rohde&Schwarz,<device type>,<part number>/serial number,<firmware version>"

Example: Rohde&Schwarz, NGE103B, 5601.1414k03/100421, 1.20

***OPC**

Operation complete

Sets bit 0 in the event status register when all preceding commands have been executed. This bit can be used to initiate a service request. The query writes a "1" into the output buffer when all preceding commands have been executed, which is useful for command synchronization.

***OPT?**

Option identification query

Queries the options included in the instrument. For a list of all available options and their description, refer to the data sheet.

Usage: Query only

***RST**

Reset

Sets the instrument to a defined default status. The default settings are indicated in the description of commands.

Usage: Setting only

***SRE** <Contents>

Service request enable

Sets the service request enable register to the indicated value. This command determines under which conditions a service request is triggered.

Parameters:

<Contents> Contents of the service request enable register in decimal form.
 Bit 6 (MSS mask bit) is always 0.
 Range: 0 to 255

***STB?**

Status byte query

Reads the contents of the status byte in decimal form.

Usage: Query only

***TST?**

Self-test query

Initiates self-tests of the instrument and returns an error code.

Return values:

<ErrorCode> **integer > 0 (in decimal format)**
 An error occurred.
 0
 No errors occurred.

Usage: Query only

***WAI**

Wait to continue

Prevents servicing of the subsequent commands until all preceding commands have been executed and all signals have settled (see also command synchronization and [*OPC](#)).

Usage: Event

***SAV** <Number>

Save

Stores the current instrument settings under the specified number in an internal memory. The settings can be recalled using the command [*RCL](#) with the associated number.

Parameters:

<Number> Range: 0..4

See also "[Store instrument settings](#)" on page 52.

***RCL <Number>**

Recall

Loads the instrument settings from an internal memory identified by the specified number. The instrument settings can be stored to this memory using the command [*SAV](#) with the associated number.

Parameters:

<Number> Range: 0..4

See also "[Recall instrument settings](#)" on page 53.

7.2 System commands

The `SYSTEM` commands perform the various system functions and configure the communication interface (LAN, WLAN) for the instrument.

SYSTEM:BEEP[*:IMMEDIATE*]

The instrument returns a single beep immediately.

Usage: Event

SYSTEM:LOCAL

This command sets the system to front panel control. The front panel control is unlocked.

Usage: Event

SYSTEM:REMOTE

This command sets the system to remote state. The front panel control is locked. By pressing **Remote**, the front panel control will be activated.

Usage: Event

SYSTEM:RWLOCK

This command sets the system to remote state. The front panel control is locked. You are only able to unlock the front panel control via SCPI command [SYSTEM:LOCAL](#) on page 73.

Usage: Event

SYSTem:OPTion?

This command returns the list of options installed on the instrument.

Return values:

<arg0>

Usage: Query only

SYSTem:TEST:BEEPer

The instrument runs the system test: Beeper Test.

Usage: Event

SYSTem:TEST:FANCtrl

The instrument runs the system test: Fan Control Test.

Usage: Event

SYSTem:TEST:KEYBacklight

The instrument runs the system test: Keypad Backlight Test.

Usage: Event

SYSTem:TEST:SCReen

The instrument runs the system test: Screen Color Test.

Usage: Event

SYSTem:COMMunicate:SOCKet:DHCP[:STATe] <arg0>

This command sets or queries LAN interface mode. ON: automatic IP address from DHCP server; OFF: manually set IP address.

Parameters:

<arg0>

Options: R&S NGE-K101

SYSTem:COMMunicate:SOCKet:IPADdress?

This command queries IP address of the LAN interface.

Return values:

<arg0>

Usage: Query only

Options: R&S NGE-K101

SYSTem:COMMunicate:WLAN:CONnect

The instrument connects to the predefined wireless access point.

Usage: Event

Options: R&S NGE-K102
Instrument with serial number below 110000

SYSTem:COMMunicate:WLAN:DISConnect

The instrument stops the connection to the predefined wireless access point.

Usage: Event

Options: R&S NGE-K102
Instrument with serial number below 110000

SYSTem:COMMunicate:WLAN:IPADdress?

This command queries the IP address of the device when the wireless interface works as a client.

Return values:

<arg0>

Usage: Query only

Options: R&S NGE-K102
Instrument with serial number below 110000

SYSTem:COMMunicate:WLAN[:STATe] <arg0>

This command activates/deactivates or queries the enable state of the wireless interface.

Parameters:

<arg0>

Options: R&S NGE-K102
Instrument with serial number below 110000

SYSTem:COMMunicate:WLAN:PASSword <arg0>

This command defines the password string of the Access Point when the wireless interface works as a client.

Parameters:

<arg0>

Usage: Setting only

Options: R&S NGE-K102
Instrument with serial number below 110000

SYSTem:COMMunicate:WLAN:SSID <arg0>

This command defines or queries the SSID string of the access point when the wireless interface works as a client.

Parameters:

<arg0>

Options:

R&S NGE-K102

Instrument with serial number below 110000

7.3 Configuration commands

The following subsystems contain the commands for channel selection, voltage and current settings for the instrument.

7.3.1 Channel selecting

The `INSTrument:Select` subsystem contains the commands for selecting the output channels.

Each channel of the power supply is considered as separate "instrument", which is required by the SCPI standard. Therefore, the SCPI commands use the `INSTrument` node to select a channel.



You can only address the number of channels a device is equipped with, e.g. two channels for the NGE102 and three channels for the NGE103.

Example: Selecting a channel

You can select a channel either with an `OUTput` parameter, or just by the channel number. This example lists all ways how you can select and query a selected channel.

```
// *****
// Select a channel
// *****
// selects channel 1
INST OUT1
// queries the channel selection
INST?
// response: "OUTPut1"
// *****
// Select a channel by its number
// *****
// selects channel number 1
INST:NSEL 1
// queries number of the channel selection
INST:NSEL?
// response: 1
```

INSTRument:NSElect <arg0>

This command defines or queries the numeric selection of a channel. Each channel of the power supply is considered as separate "instrument", which is required by the SCPI standard.

Parameters:

<arg0> {1 | 2 | 3}

Example:

```
INSTRument:NSElect 1
Selects the output channel as Ch 1.
Note: Channel 3 is only valid for NGE103B.
INSTRument:NSElect? -> 1
Return the numeric channel selection.
```

INSTRument[:SElect] <arg0>

This command defines or queries the channel selection. Each channel of the power supply is considered as separate "instrument", which is required by the SCPI standard.

Parameters:

<arg0> OUTPut1 | OUTPut2 | OUTPut3 | OUTP1 | OUTP2 | OUTP3 |
 OUT1 | OUT2 | OUT3
OUTPut1 | OUTP1 | OUT1
 Ch 1
OUTPut2 | OUTP2 | OUT2
 Ch 2
OUTPut3 | OUTP3 | OUT3
 Ch 3

Example:

```

INSTRument OUTPut1
INSTRument OUTP1
Selects the output channel as Ch 1.
INST? -> 2
Return the output channel as Ch 2.

```

7.3.2 Voltage setting

The `SOURce:VOLTage` subsystem contains the commands for setting the voltage of the output channel. The default unit is V.

Example: Configuring the output voltage

This example contains all commands to configure and query the output voltage.

```

// *****
// Select the channel
// *****
INST OUT1
// *****
// Set the voltage value
// *****
// selects a channel and sets the voltage
VOLT 10
// queries the output voltage of a channel
VOLT?
// response: 10.000
// sets the voltage to maximum or minimum respectively
VOLT MAX
VOLT MIN
// *****
// Query the range of the voltage values
// *****
// queries the upper and lower limit of the output voltage
VOLT? MIN
// response: 0.000
VOLT? MAX
// response: 32.20

```

[SOURce:]VOLTage[:LEVel][:IMMediate][:AMPLitude] <Voltage>

This command defines or queries the voltage value of the selected channel.

Parameters:

<Voltage> {<Voltage> | MINimum | MAXimum | DEFault}

<Voltage>
0.0 V to 32.2 V (adjustable in 10 mV steps)

MINimum
0.000E+00

MAXimum

32.200E+01

Default unit: V

Example:

VOLT 10

Set the voltage value to 10 V.

VOLT? -> 10

Return the voltage value of the selected channel.

7.3.3 Current setting

The `SOURCE:CURRENT` subsystem contains the commands for setting the current limit of the output channel. The default unit is A.

Example: Configuring the current output

```
// *****
// Select the channel
// *****
INST OUT1
// *****
// Set the current value
// *****
// selects a channel and sets the current
CURR 2
// queries the current of the selected channel
CURR?
// response: 2.000
// *****
// Query the range of the current values
// *****
// queries the upper and lower limit of the current
CURR? MIN
// response: 0.003
CURR? MAX
// response: 3.025
```

[SOURCE:CURRENT[:LEVEL][:IMMEDIATE][:AMPLITUDE] <Current>

This command defines or queries the current value of the selected channel.

Parameters:

<Current>

<Current>

Set the selected channel to a current range of 3 mA to 3.025 A.

Default unit: A

Example:

CURR 2

Set the selected channel current to 2 A.

CURR? -> 2

Return current value of the selected channel.

7.3.4 Combined voltage and current settings

The `APPLY` subsystem provides a command that enables you to set the current and voltage of a channel in one step.

APPLY <arg0>

This command defines or queries the voltage and current value of the selected channel.

Parameters:

<arg0> {<Voltage> | DEF | MIN | MAX} [, {<Current> | DEF | MIN | MAX}]

<Voltage>

Set voltage in the range of 0 V to 32.20 V.

DEF

Set voltage to default.

MIN

Set voltage to minimum.

MAX

Set voltage to maximum.

<Current>

Set current in the range of 3 mA to 3.025 A.

DEF

Set current to default.

MIN

Set current to minimum.

MAX

Set current to maximum.

Example:

```
INST OUT1
```

```
APPLY "6,2"
```

Set channel 1 to output 6 V and 2 A.

```
APPLY? -> 6, 2
```

Return voltage and current value of the selected channel.

7.3.5 Output setting

The `OUTPUT` subsystem contains the commands for activating the output channels.

Example: Activating the channels

You can activate a selected channel and turn on or off the outputs either individually or all outputs simultaneously. This example lists all ways how you can activate and query the outputs.

```
// *****
// Activate a channel
// *****
INST OUT1
// activates the selected channel
OUTP:SEL 1
// activates channel 1 and its output
OUTP 1
// queries the output state
OUTP?
// response: 1
// *****
// Turn on all selected channels simultaneously
// *****
// selects channels 1 and 2
// sets the voltage and current values for both channels
// activates both channels
INST:OUT1
VOLT 6
CURR 0.1
OUTP:SEL 1
INST:OUT2
VOLT 12
CURR 0.2
OUTP:SEL 1
// turns on the output of both channels
OUTP:GEN 1
```

OUTPut[:STATe] <arg0>

This command defines or queries for output state for the previous selected channel.

Parameters:

```
<arg0>          {OFF | ON | 0 | 1}
                ON | 1
                Output state will be turned on.
                OFF | 0
                Output state will be turned off.
                *RST:      OFF | 0
```

Example:

```
INST OUT1
OUTP ON
Ch 1 and output state will be activated; i.e. Ch 1 and Output key
on the front panel will be illuminated.
OUTP? -> 1
Return the output state.
```

OUTPut:GENeral <arg0>

This command activates or queries the instrument master output state.

If the master output state is activated, the **Output** key on the front panel will be illuminated.

Parameters:

<arg0> {OFF | ON | 0 | 1}
ON | 1
 Output state will be activated
OFF | 0
 Output state will be deactivated

Example:

```
INST OUT1
OUTP:SEL ON
Volt 12
Curr 0.1
Ch 1 is activated.

INST OUT2
OUTP:SEL ON
Volt 12
Curr 0.2
Ch 2 is activated.
OUTP:GEN ON
Ch 1 and Ch 2 and Output state are activated.
OUTP:GEN? -> 1
Return output state of the channel.
```

OUTPut:MODE <arg0>

Sets and queries the output operating mode of the specified channel

Parameters:

<arg0> {OFF | CV | CC}
OFF
 Output is turned off.
CV
 Output mode changed to constant voltage mode.
CC
 Output mode changed to constant current mode.
 *RST: OFF

Example:

```
OUTP:MODE CV
OUTP:MODE? -> CV
Output mode has changed to constant voltage mode.
```

OUTPut:SElect <arg0>

This command activates or queries the instrument channel state of the previous selected channel.

If the selected channel is activated, the respective channel key (i.e. **Ch 1**, **Ch 2**, **Ch 3**) on the front panel will be illuminated.

Parameters:

<arg0> {OFF | ON | 0 | 1}
ON | 1
 Selected channel will be activated.
OFF | 0
 Selected channel will be deactivated.
 *RST: OFF | 0

Example:

```
INST OUT1
OUTP:SEL ON
Ch 1 is activated.
```

```
OUTP:SEL? -> 1
```

Return the state of the selected channel.

OTP:TRIPped?

Queries the overtemperature protection (OTP) tripped state of the previous selected channel.

It is tripped if an OTP event occurs. Available from V1.50

Return values:

<arg0> {OFF | ON | 0 | 1}
ON | 1
 OTP event occurs.
OFF | 0
 OTP event not occurs.
 *RST: OFF | 0

Example:

```
OUTP:TRIP? -> 1
OTP event occurs.
```

Usage:

Query only

7.3.6 Fuse setting

The `FUSE` subsystem contains the commands for overcurrent protection parameters such as activating fuses and setting fuse parameters of the output channels. The default unit is A.

Example: Configuring fuses

This example contains all commands to configure and query the fuse states and settings.

```
// *****
// Activate a fuse
// *****
INST OUT1
// selects a channel and activates the overcurrent protection
FUSE 1
// queries the state of the overcurrent protection in the selected channel
FUSE?
// response: 1
// *****
// Set a delay time for the overcurrent protection. The delay time
// takes effect when the channel output is turned on.
// *****
// sets 0.05 s delay for the overcurrent protection
FUSE:DEL 0.05
// queries the currently set delay time of the overcurrent protection
// in the selected channel
FUSE:DEL?
// response: 0.05
// sets the delay time to maximum, minimum respectively
FUSE:DEL MAX
FUSE:DEL MIN
// *****
// Query the range of the overcurrent protection delay time
// *****
// queries the upper and lower limit of the
// overcurrent protection delay time in s
FUSE:DEL? MIN
// response: 0
FUSE:DEL? MAX
// response: 10
// *****
// Query a tripped overcurrent protection
// *****
INST OUT1
//queries whether the OCP in channel 1 has tripped
FUSE:TRIP?
//response: 1 OCP is tripped
//response: 0 OCP is not tripped
//resets a tripped OCP in the selected channel
FUSE:TRIP:CLEAR
// *****
// Link the electronic overcurrent protection of the channels logically
// *****
INST OUT1
// links the overcurrent protection of channel 1 with channel 2
```

```

FUSE:LINK 2
// queries the combined overcurrent protection of the selected channel
FUSE:LINK? 2
// response 1
// *****
// Unlink linked overcurrent protection
// *****
FUSE:UNLink 2
// queries the combined overcurrent protection of the selected channel
FUSE:LINK? 2
// response 0

```

FUSE:DELay <Delay>

This command defines and queries the fuse delay for the previous selected channel.

Parameters:

<Delay> {<Delay> | MIN | MAX}

<delay>
 0 s to 10 s (adjustable in 0.010 s steps e.g. FUSE:DEL 0.010 = 0.01 s)

MIN
 Set fuse delay to minimum.

MAX
 Set fuse delay to maximum.

 Default unit: s

Example:

```

INST OUT1
FUSE:DEL 0.050
Set fuse delay of channel 1 to 50 ms.
FUSE:DEL? -> 0.05
Return the fuse delay time of the selected channel.

```

FUSE:LINK <arg0>

This command defines or queries the channel fuses (fuse linking) for the previous selected channel.

Parameters:

<arg0> **1**
 Channel Ch 1.

2
 Channel Ch 2.

3
 Channel Ch 3.

Example: INST OUT1
 FUSE:LINK 2
 Fuse Ch 1 is linked with Ch 2.
 FUSE:LINK? 2 -> 1
 If the fuse of Ch 1 is linked with Ch 2, a "1" is returned.
 FUSE:LINK? 3 -> 0
 If the fuse of Ch 1 is not linked with Ch 3, a "0" is returned.

FUSE:TRIPped?

This command queries the fuse tripped of the previous selected channel.

Return values:

<arg0> **ON**
 Fuse is tripped.
 OFF
 Fuse is not tripped.

Example: INST OUT1
 FUSE:TRIP? -> 0
 Fuse of Ch 1 has not tripped.

Usage: Query only

FUSE:UNLink <arg0>

This command unlinks the channel fuses (fuse linking) for the previous selected channel.

Parameters:

<arg0> **1**
 Channel Ch 1.
 2
 Channel Ch 2.
 3
 Channel Ch 3.

Example: INST OUT1
 FUSE:LINK 2
 FUSE:UNL 2
 Fuse Ch 1 is unlinked with Ch 2.

Usage: Setting only

FUSE[:STATe] <arg0>

This command defines or queries the fuse for the previous selected channel.

Parameters:

<arg0> {0 | 1}

1
Fuse will be activated.

0
Fuse will be deactivated.

*RST: OFF | 0

Example:

```
INST OUT1
FUSE ON
Fuse of Ch 1 is activated
FUSE? -> 1
Return fuse state of the selected channel.
```

7.3.7 OVP setting

The `VOLTage:PROTection` subsystem contains the commands for setting the over-voltage protection parameters for the output channels. The default unit is V.

Example: Configuring the overvoltage protection

```

// *****
// Set the overvoltage protection value
// *****
INST OUT1
//activates the OVP of the previous selected channel
VOLT:PROT 1
// selects a channel and sets the OVP
VOLT:PROT:LEV 5
// queries the output overvoltage value of a channel
VOLT:PROT:LEV?
// response: 5
// queries the OVP state of the previous selected channel
VOLT:PROT?
// response: 1
// sets the overvoltage protection to maximum,
// or minimum respectively
VOLT:PROT:LEV MAX
VOLT:PROT:LEV MIN
// *****
// Query the range of the overvoltage protection values
// *****
// queries the upper and lower limit
VOLT:PROT:LEV? MIN
// response: 0.100
VOLT:PROT:LEV? MAX
// response: 32.2
// *****
// Query a tripped overvoltage protection
// *****
INST OUT1
// queries whether the OVP in channel 1 has tripped
VOLT:PROT:TRIP?
// response: 1 OVP is tripped
// response: 0 OVP is not tripped
// resets a tripped OVP in the selected channel
VOLT:PROT:CLEAr
// *****
// Set the overvoltage protection mode
// *****
INST OUT1
// sets OVP protected mode for channel1
VOLT:PROT:MODE PROT
// queries the OVP mode
VOLT:PROT:MODE PROT?
// response: "protected"

```

[SOURCE:]VOLTage:PROTection:MODE <arg0>

This command defines or queries the OVP mode for the previous selected channel.

Parameters:

<arg0> MEASured | PROTected

MEASured

The OVP switches off if the measured value exceeds the threshold.

PROTected

If the adjusted threshold is exceeded the output of the instrument will be not switched on; additionally the measured value is monitored (please also refer to function MEASured).

Example:

```
INST OUT1
VOLT:PROT:MODE PROT
Sets OVP protected mode for Ch 1.
VOLT:PROT:MODE? -> PROTected
Return the selected channel OVP mode.
```

[SOURCE:]VOLTage:PROTection:TRIPped?

This command queries the OVP tripped status of the previous selected channel.

Return values:

<arg0> ON | OFF
ON
OVP is tripped
OFF
OVP is not tripped

Example:

```
INST OUT1
VOLT:PROT:TRIP? -> OFF
OVP of Ch 1 has not tripped.
```

Usage:

Query only

[SOURCE:]VOLTage:PROTection[:STATe] <arg0>

This command defines or queries the OVP state for the previous selected channel.

Parameters:

<arg0> 1 | 0
1
OVP is activated.
0
OVP is deactivated.

Example:

```
INST OUT1
VOLT:PROT ON
OVP of Ch 1 is activated.
VOLT:PROT? -> 1
Return the OVP state of the selected channel.
```

[SOURce:]VOLTage:PROTection:LEVel <Voltage>

This command defines or queries the OVP value of the previous selected channel.

Parameters:

<Voltage> {<Voltage> | MIN | MAX}

<Voltage>

Set the OVP value in the range of 0 mV up to 32.2 V (adjustable in 100 mV steps)

MIN

Set the OVP value to minimum.

MAX

Set the OVP value to maximum.

Default unit: V

Example:

```
INST OUT1
VOLT:PROT:LEV 5
Set the OVP value of Ch 1 to 5 V.
VOLT:PROT:LEV?
Return the selected channel OVP value.
```

[SOURce:]VOLTage:PROTection:CLEAr

This command resets the OVP state of the selected channel. If the OVP has tripped the OVP message on the display will be cleared for the selected channel.

Usage: Event

7.3.8 OPP setting

The POWer:PROTection subsystem contains the commands for setting the over-power protection parameters for the output channels. The default unit is W.

Example: Configuring the overpower protection

```
// *****
// Set the overpower protection value
// *****
INST OUT1
//activates the OPP of the previous selected channel
POW:PROT 1
// selects a channel and sets the OPP
POW:PROT:LEV 5
// queries the output overvoltage value of a channel
POW:PROT:LEV?
// response: 5
// queries the OPP state of the previous selected channel
POW:PROT?
// response: 1
// sets the overvoltage protection to maximum,
// or minimum respectively
POW:PROT:LEV MAX
POW:PROT:LEV MIN
// *****
// Query the range of the overpower protection values
// *****
// queries the upper and lower limit
POW:PROT:LEV? MIN
// reponse: 0.0
POW:PROT:LEV? MAX
// reponse: 32.0
// *****
// Query a tripped overpower protection
// *****
INST OUT1
// queries whether the OPP in channel 1 has tripped
POW:PROT:TRIP?
// response: 1 OPP is tripped
// response: 0 OPP is not tripped
// resets a tripped OPP in the selected channel
POW:PROT:CLEAr
```

[SOURCE:]POWER:PROTECTION:LEVEL <Power>

This command defines or queries the OPP value of the previous selected channel.

Parameters:

<Power>

{<Voltage> | MIN | MAX}

<Voltage>

Set the OPP value in the range of 0 W up to 32 W (adjustable in 100 mW steps).

MIN

Set the OPP value to minimum.

MAX

Set the OPP value to maximum.

Default unit: W

Example:

```
INST OUT1
```

```
POW:PROT:LEV 5
```

Set the OPP value of channel 1 to 5 W.

```
POW:PROT:LEV? -> 5
```

Return the selected channel OPP value.

[SOURce:]POWER:PROTECTION:TRIPped?

This command queries the OPP tripped status of the previous selected channel

Return values:

<arg0> 1 | 0

1

OPP is tripped.

0

OPP is not tripped.

Example:

```
INST OUT1
```

```
POW:PROT:TRIP? -> 0
```

OPP state of Ch 1 has not tripped.

Usage:

Query only

[SOURce:]POWER:PROTECTION[:STATE] <arg0>

This command defines or queries the OPP state for the previous selected channel.

Parameters:

<arg0> ON | OFF | 1 | 0

ON | 1

OPP is activated.

OFF | 0

OPP is deactivated.

Example:

```
INST OUT1
```

```
POW:PROT ON
```

OPP of Ch 1 is activated.

```
POW:PROT?
```

Return the OPP state of the selected channel.

[SOURce:]POWER:PROTECTION:CLEAR

This command resets the OPP state of the selected channel. If the OPP has tripped the red blinking OPP message on the display will be cleared for the selected channel.

Usage:

Event

7.4 Measurement commands

The MEASure subsystem provides commands to query the voltage and current values of a channel.

MEASure[:SCALar]:CURRent[:DC]?

This command queries the measured current value of the previous selected channel.

Return values:

<Current> <numeric_value>
Return the measured current.
Default unit: A

Example: MEAS:CURR? -> 1.000

Usage: Query only

MEASure[:SCALar]:POWer?

This command queries the measured power value of the previous selected channel.

Return values:

<Power> <Numeric_value>
Return the measured power value.
Default unit: W

Example: MEAS:POW? -> 3.00E+00
Return the measured power value of the selected channel.

Usage: Query only

MEASure[:SCALar][:VOLTage][:DC]?

This command queries the measured voltage value of the previous selected channel.

Return values:

<Voltage> <numeric_value>
Return the measured voltage.
Default unit: V

Example: MEAS? -> 1.000E+00

Usage: Query only

7.5 Advanced operating commands

The following shows the subsystem that contains the commands for configuring the arbitrary function, EasyRamp and Digital I/O functions.

7.5.1 Arbitrary commands

The ARBbitrary subsystem contains the commands for configuring an arbitrary sequence for the output channels.

Example: Configuring an arbitrary sequence

This programming example generates an arbitrary sequence for a selected channel. The sequence starts at 1 V and 1 A for 1 sec, and both values are incremented each second by 1. The generated arbitrary waveform is transferred to Ch 1. When activated, the R&S NGE100B provides the arbitrary waveform at the output of the selected channel, and repeats it 10 times.

```
// *****
// Define and start the EasyArb sequence
// *****
// selects channel 1
INST OUT1
// defines the sequence, i.e. starting at 1V, 1A for 1sec,
// and increments the voltage and current each second by 1
ARB:DATA "1,1,1,0,2,2,1,0,3,3,1,0"
// sets the repetition rate
ARB:REP 10
// ARB:REP? queries the set number of repetitions
// ARB:POIN? queries the number of arbitrary points of EasyArb waveform
// Enable the arbitrary sequence
ARB 1
// starts the sequence in channel 1
// ARB 0 stops the sequence in the selected channel
// turns on the output
OUTP ON
// *****
// Save and recall an arbitrary sequence
// *****
// saves the sequence into the internal memory, e.g. M1
ARB:SAV 1
// recalls a previously saved sequence from the internal memory
ARB:RCL 1
// atarts the previous transferred EasyArb waveform in channel 1
ARB:START
// atops the EasyArb waveform in channel 1 if EasyArb is running
ARB:STOP
// clears the arbitrary table data for the selected channel
ARB:CLEAR
```

ARBbitrary:CLEAr

This command clears the previous defined arbitrary waveform data for channel 1.

Usage: Event

ARbitrary:DATA <arg0>

Defines or queries the arbitrary points for channel 1. The dwell time between two points is from 10ms to 600s.

Parameters:

<arg0> <Voltage1, Current1, Time1, Voltage2, Current2, Time2,..., Voltage128, Current128, Time128>

Voltage1 ... Voltage128

Defines the arbitrary points of the voltage.

Current1 ... Current128

Defines the arbitrary points of the current.

Time1 ... Time128

Defines the arbitrary points of the time (The unit for time is ms).

Example:

```
ARB:DATA "10.5,3,10,20,2,1000,15,2.1,10000"
```

ARbitrary:RCL <arg0>

This command recalls EasyArb settings and previous defined arbitrary points from the respective memory locations M1-M5.

Parameters:

<arg0> Range: 0..4

Usage: Setting only

ARbitrary:REPetitions <Repetitions>

This command defines or queries the repetition of the defined arbitrary waveform for channel 1.

Note: If the repetition is set to "0", the arbitrary waveform repeats continuously.

Parameters:

<Repetitions> 0..255

Example:

```
ARB:REP 10
```

Set the repetition rate of the defined arbitrary waveform as 10.

```
ARB:REP? -> 10
```

Return the defined repetition rate of the selected channel.

ARbitrary:POINTs?

This command returns the number of arbitrary points of EasyArb waveform.

Return values:

<arg0>

Usage: Query only

ARbitrary[:STATe] <arg0>

This command activates/deactivates or queries the EasyArb state. ON: Ch 1 is ready to run arb waveform.

Parameters:

<arg0> {OFF | ON}

ON
EasyArb state is activated.

OFF
EasyArb state is deactivated.

ARbitrary:SAV <arg0>

This command saves EasyArb settings and previous defined arbitrary points into the respective memory locations M1-M5.

Parameters:

<arg0> Range: 0..4

Example: INST 1
ARB:DATA 10,1,0,5,0
ARB:REP 10
ARB:SAV 1

Usage: Setting only

ARbitrary:START

This command starts the previous transferred EasyArb waveform in channel 1 if EasyArb is enabled.

Usage: Event

ARbitrary:STOP

This command stops the EasyArb waveform in channel 1 if EasyArb is running.

Usage: Event

7.5.2 EasyRamp commands

The `VOLTage:RAMP` subsystem contains the commands for configuring the ramp function for the output channels.

[SOURce:]VOLTage:RAMP:DURation <Time>

This command sets/queries the EasyRamp duration of the previous selected channel in seconds. 0.01 s to 10 s in steps of 0.01 s.

Parameters:

<Time> Range: 0.010 to 10
 *RST: 0.010
 Default unit: s

[SOURce:]VOLTage:RAMP[:STATe] <arg0>

This command defines/queries the EasyRamp state for the previous selected channel.

Parameters:

<arg0> {OFF | ON}
 ON
 EasyRamp function is activated.
 OFF
 EasyRamp function is disabled.

7.5.3 DIO commands

The DIO subsystem contains the commands for configuring a Digital I/O function for the output channels.

TRIGger:DIRection:DIO<IO> <arg0>

This command sets or queries the specified Digital I/O line to function as Trigger Input or Trigger Output.

Suffix:

<IO> 1..4

Parameters:

<arg0> OUTPut | INPut

Example: TRIG:DIR:DIO2 OUT

TRIGger[:ENABLE]:DIO<IO> <arg0>

This command sets or queries the state of the specified Digital I/O line.

The state is disabled when any setting has been changed.

Suffix:

<IO> 1..4

Parameters:

<arg0> {OFF | ON}
 ON
 Enable the state for Digital I/O line.
 OFF
 Disable the state for Digital I/O line.
 *RST: OFF

TRIGger:IN:ARBitrary:DIO<IO> <arg0>

This command sets or queries the operation mode when starting EasyArb by Trig IN.

Suffix:

<IO> 1..4

Parameters:

<arg0> PULSe | LEVeL

PULSe

Starts EasyArb when trigger signal activated.

LEVeL

Starts EasyArb when trigger signal activated and stops when trigger signal de-activated.

*RST: PULSe

Example:

TRIG:IN:ARB:DIO1 PULS

TRIGger:IN:RESPonse:DIO<IO> <arg0>

This command sets or queries the output response of the trigger input of the specified Digital I/O line.

Suffix:

<IO> 1..4

Parameters:

<arg0> ON | OFF | TOGGle | INHibit | ARBitrary

ON

Output is switched on.

OFF

Output is switched off.

TOGGle

Output state is toggled.

INHibit

Output state remains off as long as the TRIG IN signal is activated.

ARBitrary

Starts the EasyArb function. If level signal is selected, the Easy-Arb function is stopped when TRIG IN signal is deactivated.

*RST: OFF

TRIGger:IN:SOURce:DIO<IO> <arg0>

This command sets or queries the source under control of the trigger input of the specified Digital I/O line.

Suffix:

<IO> 1..4

Parameters:

<arg0> **CH1**
Trigger input source from Ch 1.

CH2
Trigger input source from Ch 2.

CH3
Trigger input source from Ch 3.

*RST: CH1

TRIGger:LOGic:DIO<IO> <arg0>

This command sets or queries the trigger logic (Active High/Active Low) of the specified Digital I/O line.

Suffix:

<IO> 1..4

Parameters:

<arg0> LOW | HIGH

*RST: HIGH

TRIGger:MASTER[:STATE] <arg0>

This command defines or queries the master enable state for the Digital I/O interface. The state is disabled when any setting has been changed.

Parameters:

<arg0> {OFF | ON}

ON
"Master Enable" state is activated for all DIO interfaces.

OFF
"Master Enable" state is deactivated for all DIO interfaces.

*RST: OFF

TRIGger:OUT:CONDition:DIO<IO> <arg0>

This command sets the trigger condition of the trigger output of the specified Digital I/O line.

The line triggers when the output of the specified control source is turned off or on

Suffix:

<IO> 1..4

Parameters:

<arg0> ON | OFF | FUSetrip | CCMode | VOLTlevel | CURRlevel | CRITevent | ARBitrary

ON

Trigger output is turned on.

OFF

Trigger output is turned off.

FUSetrip

Trigger output is linked to fuse tripped event.

VOLTlevel

Trigger output is linked to a set voltage level event.

CURRlevel

Trigger output is linked to a set current level event.

CRITevent

Trigger output is linked to a critical triggered event.

ARbitrary

Trigger output is linked to a EasyArb event.

*RST: ON

TRIGger:OUT:CRITevent:DIO<IO> <arg0>

This command sets or queries the critical event of the trigger output of the specified Digital I/O line.

Suffix:

<IO> 1..4

Parameters:

<arg0> OVP | OPP | OTP

OVP

Trigger output is linked to the OVP event.

OPP

Trigger output is linked to the OPP event.

OTP

Trigger output is linked to the OTP event.

*RST: OVP

TRIGger:OUT:CURRlevel:DIO<IO> <Current>

This command sets or queries the threshold current level of the trigger output of the specified Digital I/O line.

Triggers when output current level exceeds or equals to the set level.

Suffix:

<IO> 1..4

Parameters:

<Current> *RST: 3.000
Default unit: A

TRIGger:OUT:SOURce:DIO<IO> <arg0>

This command sets or queries the control source of the trigger output of the specified Digital I/O line.

Suffix:

<IO> 1..4

Parameters:

<arg0> **CH1**
Trigger output source from Ch 1.
CH2
Trigger output source from Ch 2.
CH3
Trigger output source from Ch 3.
*RST: CH1

TRIGger:OUT:VOLTlevel:DIO<IO> <Voltage>

This command sets or queries the threshold voltage level of the trigger output of the specified Digital I/O line.

Triggers when output voltage level exceeds or equals to the set level.

Suffix:

<IO> 1..4

Parameters:

<Voltage> *RST: 0.0
Default unit: V

TRIGger:RCL <arg0>

This command recalls DIO settings from the respective memory locations M1-M5.

Parameters:

<arg0> Range: 0..4

Example: TRIG:RCL 1

Usage: Setting only

TRIGger:SAV <arg0>

This command saves DIO settings into the respective memory locations M1-M5

Parameters:

<arg0> Range: 0..4

Example: TRIG:SAV 1

Usage: Setting only

7.6 Data and file management commands

The `HCOPY` subsystem contains commands for managing the output of the screen environment.

`HCOPY:DATA?`

This command queries current screen content. BMP format is supported.

Return values:

<arg0>

Usage: Query only

`HCOPY:SIZE:X?`

This command returns the horizontal expansion of the screenshots.

Return values:

<arg0>

Usage: Query only

`HCOPY:SIZE:Y?`

This command returns the vertical expansion of the screenshots.

Return values:

<arg0>

Usage: Query only

7.7 Firmware update

The following shows the subsystem that contains the commands for firmware update function.

`DIAGnostic:SERvice:FWUP <arg0>`

Starts instrument firmware update remotely.

For more information, see [Chapter 6.10.6, "Updating the firmware"](#), on page 68.

Parameters:

<arg0>

Example: `DIAGnostic:SERvice:FWUP "NGE100FWRelease.tar.gz.enc"`

Usage: Setting only

8 Maintenance and support

8.1 Maintenance

Regular maintenance improves the life span of the instrument, the following chapter provides information on instrument maintenance.

Cleaning

Before cleaning the instrument, ensure that it has been switched off and the power cable is disconnected.

Clean the outer case of the instrument at regular intervals, using a soft, lint-free dust cloth.

NOTICE

Instrument damage caused by cleaning agents

Use a dry, lint-free cloth to clean the product. When cleaning, keep in mind that the casing is not waterproof. Do not use any liquids for cleaning.

Cleaning agents, solvents (thinners, acetone), acids and bases can damage the front panel labeling, plastic parts and display.

The display may only be cleaned with an appropriate glass cleaner. Rub the display with a dry, clean and lint-free cloth. Do not allow cleaning fluid to enter the instrument.

8.2 Contacting customer support

Technical support – where and when you need it

For quick, expert help with any Rohde & Schwarz product, contact our customer support center. A team of highly qualified engineers provides support and works with you to find a solution to your query on any aspect of the operation, programming or applications of Rohde & Schwarz products.

Contact information

Contact our customer support center at www.rohde-schwarz.com/support, or follow this QR code:



Figure 8-1: QR code to the Rohde & Schwarz support page

9 Applications

9.1 Parallel and series mode

⚠ WARNING

It is assumed that only qualified and trained personnel service the power supplies and the connected loads.

NOTICE

Use only the R&S NGE100B power supply series when operating the channels in a series or parallel mode to increase the output voltage and current.

⚠ DANGER**Series connection**

A series connection may cause dangerous voltages.

To increase output voltage and currents, it is possible to operate the channels in series or parallel mode. In general, the output voltages of R&S NGE100B to be combined are independent.

9.1.1 Series mode

This type of interconnection adds the individual output voltages. The same current flows through all outputs. The current limits for the outputs wired in series should be set to the identical value. If one of the outputs exceeded the current limit, the total voltage will naturally collapse. See [Chapter 5.5, "Operation modes"](#), on page 37.

It is advisable to set the voltages of all connected channels voltages to a similar value to distribute the loads evenly (not absolutely necessary). When all three channels are connected in a series mode and if a (low resistance) load is connected; there is a chance of damaging a channel when that channel is switch off. This is due to the protection diode working as a bypass to connect the other channel in a series mode. Once the protection diode is shorted, the channel will be defective.

Therefore, it is necessary to always have all channels or no channel at all switched on.



If the instrument switches to constant current output mode (CC) during a series connection, the voltage display becomes inaccurate.

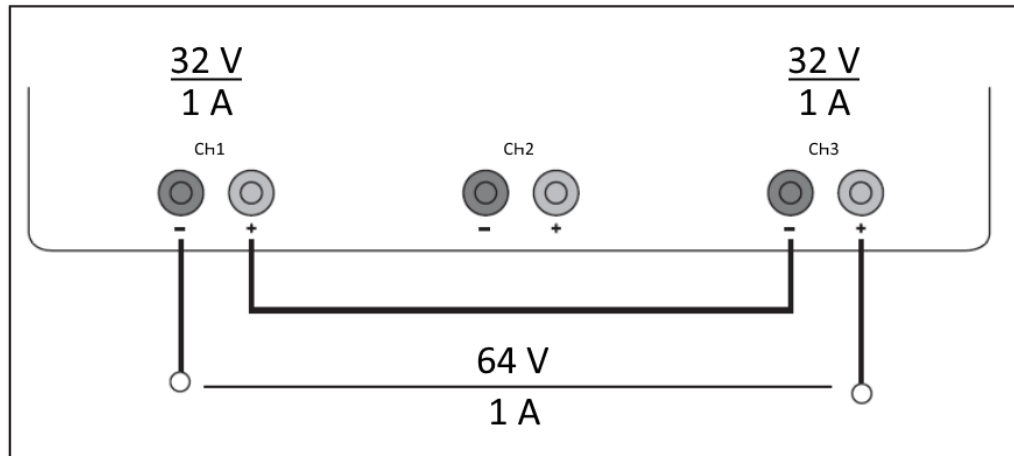

Figure 9-1: Example of series connection

9.1.2 Parallel mode

If it is necessary to increase the total current, the power supply outputs must be wired in parallel. The maximum total current is the sum of the individual currents of all sources connected in parallel. The output voltages for the individual outputs should be set to the same voltage value as precisely as possible. For slight voltage differences, it is common in this operating mode to first charge a voltage output up to the current limit; the other voltage output provides the remaining current. See "[Principles of operation in parallel mode](#)" on page 107.

For power supplies that are connected in parallel, it is possible that compensating currents flow within the power supplies. The use of power supplies by other manufacturers, which are potentially not overload proof, can cause destruction of these units as currents may be distributed unevenly.

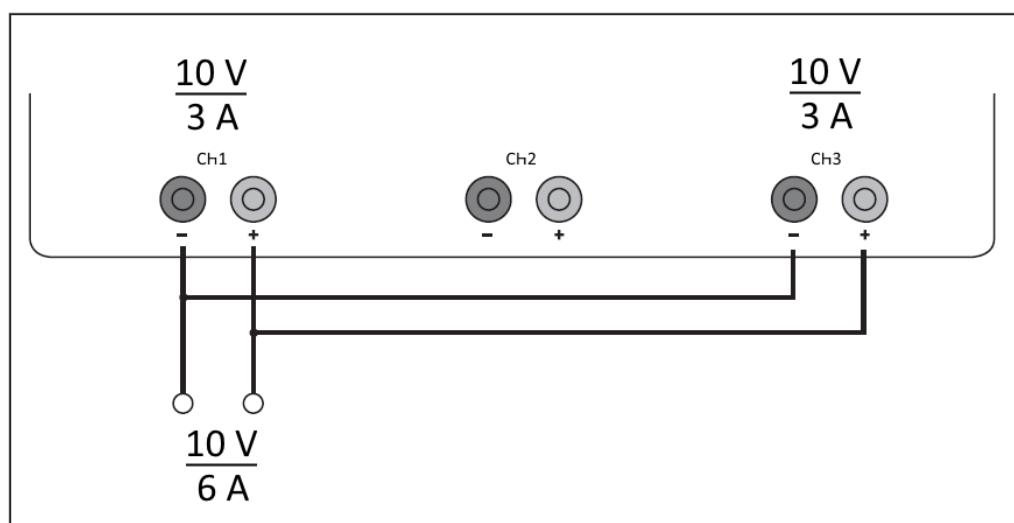

Figure 9-2: Example of parallel connection

Principles of operation in parallel mode

Generally, a higher current will first be supplied from the channel with the higher output voltage. Once this channel reaches its power limit, the remaining current will be made available by the channel that is connected in parallel. In this scenario, it is unpredictable which channel will supply the higher current because it is also possible for channels with identical voltage values to display a low voltage difference.

By increasing the voltage slightly, the load distribution can be manipulated. If the voltage for a channel is to be increased by 50mV, for instance (by a set of identical cables), the current will initially be provided by this channel.

If you wish to distribute the load to multiple channels, it is recommended to set the current limit of the channel that is to supply the main current to a fraction of the current. This approach handles the semiconductor with care and improves the heat dissipation, as the power loss is distributed more evenly.

Annex

A Additional basics on remote control

A.1 Messages and command structure

A.1.1 Messages

Instrument messages are employed in the same way for all interfaces, if not indicated otherwise in the description.

- Structure and syntax of the instrument messages: [Chapter A.1.2, "SCPI command structure"](#), on page 109
- Detailed description of all messages: [Chapter 7, "Remote control commands"](#), on page 70

There are different types of instrument messages:

- Commands
- Instrument responses

Commands

Commands (program messages) are messages which the controller sends to the instrument. They operate the instrument functions and request information. The commands are subdivided according to two criteria:

Effects on the instrument:

- Setting commands cause instrument settings such as a reset of the instrument or setting the output voltage.
- Queries return data for remote control, e.g. for identification of the instrument or polling a parameter value. Queries are formed by appending a question mark to the command header.

Applied standards:

- The function and syntax of the common commands are precisely defined in standard IEEE 488.2. If implemented, they are used identically on all instruments. They refer to functions such as management of the standardized status registers, reset and self-test.
- Instrument control commands refer to functions depending on the features of the instrument such as voltage settings. Many of these commands have also been standardized by the SCPI committee. These commands are marked as "SCPI compliant" in the command reference chapters. Commands without this SCPI label

are device-specific, however, their syntax follows SCPI rules as permitted by the standard.

Instrument responses

Instrument responses (response messages and service requests) are messages which the instrument sends to the controller after a query. They can contain measurement results, instrument settings and information on the instrument status.

A.1.2 SCPI command structure

SCPI commands consist of a so-called header and, usually, one or more parameters. The header and the parameters are separated by a whitespace. The headers can consist of several mnemonics (keywords). Queries are formed by appending a question mark directly to the header. The commands can be either device-specific or device-independent (common commands). Common and device-specific commands differ in their syntax.

Syntax for common commands

Common (= device-independent) commands consist of a header preceded by an asterisk (*) and possibly one or more parameters.

Table A-1: Examples of common commands

Command	Command name	Description
*RST	Reset	Resets the instrument.
*ESE	Event Status Enable	Sets the bits of the event status enable registers.
*ESR?	Event Status Query	Queries the content of the event status register.
*IDN?	Identification Query	Queries the instrument identification string.

Syntax for device-specific commands

For demonstration purposes only, assume the existence of the following commands for this section:

- MEASure:CURRent[:DC]?
- MEASure:VOLTage[:DC]?
- FUSE[:STATe] {0 | 1}
- FUSE[:STATe]?

Long and short form

The mnemonics feature a long form and a short form. The short form is marked by uppercase letters, the long form corresponds to the complete word. You can enter either the short form or the long form; other abbreviations are not permitted.

Example:

MEASure:CURRent? is equivalent to MEAS :CURR?

**Case-insensitivity**

Uppercase and lowercase notation only serves to distinguish the two forms in the manual, the instrument itself is case-insensitive.

Optional mnemonics

Some command systems permit inserting or omitting certain mnemonics in the header. These mnemonics are marked by square brackets. The instrument must recognize the long command to comply with the SCPI standard. Some commands are shortened by these optional mnemonics.

Example:

FUSE[:STATe] { ON }

FUSE:STAT ON is equivalent to FUSE ON

Special characters

Table A-2: Special characters

	A vertical stroke in parameter definition indicates alternative possibilities in the sense of "or". The effect of the command differs, depending on the used parameter. Example: <ul style="list-style-type: none"> • FUSE:LINK {1 2 3} • FUSE:LINK 1 sets the fuse link CH 1 for the selected channel FUSE:LINK 2 sets the fuse link of CH 2 for the selected channel
[]	Mnemonics in square brackets are optional and can be inserted into the header or be omitted. Example: <ul style="list-style-type: none"> • FUSE[:STATe] { ON } • FUSE:STAT ON is equivalent to FUSE ON
{ }	Parameters in curly brackets are optional and can be inserted once or several times, or be omitted. Example: <ul style="list-style-type: none"> • VOLTage[:LEVel][:IMMediate][:AMPLitude] {<voltage> MIN MAX UP DOWN } <p>The following are valid commands:</p> <ul style="list-style-type: none"> – VOLT MAX – VOLT MIN – VOLT 10

SCPI parameters

Many commands are supplemented by a parameter or a list of parameters. The parameters must be separated from the header by a whitespace (ASCII code 0 to 9, 11 to 32 decimal, e.g. blank). If several parameters are specified in a command, they are separated by a comma ",".

Allowed parameters are:

- Numeric values
- Special numeric values
- Boolean parameters

- Text
- Character strings
- Block data

The required parameters and the allowed value range are specified in the command description.

Numeric values

You can enter numeric values in the following form. Values exceeding the resolution of the instrument are rounded up or down.

Example:

```
VOLT 10V = VOLT 10
```

```
VOLT 100mV = VOLT 0.1
```

Special numeric values

The text listed below are interpreted as special numeric values. In the case of a query, the numeric value is provided.

- MIN / MAX
- MINimum and MAXimum denote the minimum and maximum value.

Example:

```
VOLT:PROT? MAX
```

Returns the maximum numeric value.

Boolean parameters

Boolean parameters represent two states:

- **On** (logically true), is represented by "On" or the numeric value "1"
- **Off** (logically false), is represented by "Off" or the numeric value "0"

The instrument returns the numerical value when queried.

Example:

```
OUTP:STAT ON
```

```
OUTP:STAT?
```

Response: 1

Text

Text parameters observe the syntactic rules for key words, i.e. they can be entered using a short or long form. Like any parameter, they have to be separated from the header by a white space.

Example:

```
VOLTage:PROTection:MODE MEASured
```

```
VOLTage:PROTection:MODE MEAS
```

```
VOLTage:PROTection:MODE?
```

```
Response: MEASured
```

Strings

Strings must always be entered in quotation marks (' or ").

Example:

```
SYSTem:COMMunicate:SOCKet:IPAdDress "192.168.1.128"
```

```
SYSTem:COMMunicate:SOCKet:IPAdDress '192.168.1.128'
```

Block data

Block data are a transmission format which is suitable for the transmission of large amounts of data. A command using a block data parameter has the following structure:

Example:

```
HEADer:HEADer #45168xxxxxxxx
```

ASCII character # introduces the data block. The next number indicates how many of the following digits describe the length of the data block. In the example, the four following digits indicate the length to be 5168 bytes. The data bytes follow. During the transmission of these data bytes all end or other control signs are ignored until all bytes are transmitted.

Overview of syntax elements

The following table provides an overview of the syntax elements:

Table A-3: Syntax elements

:	A colon separates the mnemonics of a command.
;	The semicolon separates two commands within a program message. It does not alter the path.
,	A comma separates several parameters of a command.
?	A question mark forms a query.
*	An asterisk marks a common command.
"	Quotation marks introduce a string and terminate it.
	A whitespace (ASCII-Code 0 to 9, 11 to 32 decimal, e.g. blank) separates the header from the parameters.

Responses to queries

You can query each setting command by adding a question mark. According to SCPI, the responses to queries are partly subject to stricter rules than in the standard IEEE 488.2.

- The requested parameter is transmitted without a header.

VOLTage:PROTection:MODE?

Response: "MEASure"

- Maximum values, minimum values and all other quantities that are requested via a special text parameter are returned as numeric values.

VOLT:PROT? MAX

Response: 32.500

- Boolean values are returned as 0 (for Off) and 1 (for On).

OUTPut:STATe?

Response: 1

A.2 Command sequence and synchronization

A sequential command finishes the execution before the next command is starting. To make sure that commands are actually carried out in a certain order, each command must be sent in a separate command line.



As a rule, send commands and queries in different program messages.

A.2.1 Preventing overlapping execution

Table A-4: Synchronization using *OPC, *OPC? and *WAI

Command	Action	Programming the controller
*OPC	Sets the Operation Complete bit in the ESR after all previous commands have been executed.	<ul style="list-style-type: none"> • Setting bit 0 in the ESE • Setting bit 5 in the SRE • Waiting for service request (SRQ)
*OPC?	Stops command processing until 1 is returned. It occurs after the Operation Complete bit has been set in the ESR. This bit indicates that the previous setting has been completed.	Sending *OPC? directly after the command whose processing should be terminated before other commands can be executed.
*WAI	Stops further command processing until all commands have been executed before *WAI.	Sending *WAI directly after the command whose processing should be terminated before other commands are executed

To prevent an overlapping execution of commands the commands *OPC, *OPC? or *WAI can be used. All three commands cause a certain action only to be carried out after the hardware has been set. The controller can be forced to wait for the corresponding action.



The R&S NGE100B series does not support parallel processing of remote commands. If OPC? returns a "1", the device is able to process new commands.

List of commands

[SOURce:]CURRent[:LEVel][:IMMediate][:AMPLitude].....	79
[SOURce:]POWer:PROTection:CLEar.....	92
[SOURce:]POWer:PROTection:LEVel.....	91
[SOURce:]POWer:PROTection:TRIPped?.....	92
[SOURce:]POWer:PROTection[:STATe].....	92
[SOURce:]VOLTage:PROTection:CLEar.....	90
[SOURce:]VOLTage:PROTection:LEVel.....	90
[SOURce:]VOLTage:PROTection:MODE.....	89
[SOURce:]VOLTage:PROTection:TRIPped?.....	89
[SOURce:]VOLTage:PROTection[:STATe].....	89
[SOURce:]VOLTage:RAMP:DURation.....	96
[SOURce:]VOLTage:RAMP[:STATe].....	97
[SOURce:]VOLTage:LEVel[:IMMediate][:AMPLitude].....	78
*CLS.....	70
*ESE.....	70
*ESR?.....	71
*IDN?.....	71
*OPC.....	71
*OPT?.....	71
*RCL.....	73
*RST.....	71
*SAV.....	72
*SRE.....	72
*STB?.....	72
*TST?.....	72
*WAI.....	72
APPLY.....	80
ARBitrary:CLEar.....	94
ARBitrary:DATA.....	95
ARBitrary:POINts?.....	95
ARBitrary:RCL.....	95
ARBitrary:REPetitions.....	95
ARBitrary:SAV.....	96
ARBitrary:START.....	96
ARBitrary:STOP.....	96
ARBitrary[:STATe].....	96
DIAGnostic:SERVice:FWUP.....	102
FUSE:DELay.....	85
FUSE:LINK.....	85
FUSE:TRIPped?.....	86
FUSE:UNLink.....	86
FUSE[:STATe].....	86
HCOPY:DATA?.....	102
HCOPY:SIZE:X?.....	102
HCOPY:SIZE:Y?.....	102
INSTrument:NSElect.....	77
INSTrument[:SElect].....	77

MEASure[:SCALar]:CURRent[:DC]?	93
MEASure[:SCALar]:POWer?	93
MEASure[:SCALar]:VOLTagE[:DC]?	93
OTPe:TRIPped?	83
OUTPut:GENeral	82
OUTPut:MODE	82
OUTPut:SELeCt	83
OUTPut[:STATe]	81
SYSTem:BEEPer[:IMMediate]	73
SYSTem:COMMunicate:SOCKeT:DHCP[:STATe]	74
SYSTem:COMMunicate:SOCKeT:IPAdDress?	74
SYSTem:COMMunicate:WLAN:CONNeCt	75
SYSTem:COMMunicate:WLAN:DISConneCt	75
SYSTem:COMMunicate:WLAN:IPAdDress?	75
SYSTem:COMMunicate:WLAN:PASSword	75
SYSTem:COMMunicate:WLAN:SSID	76
SYSTem:COMMunicate:WLAN[:STATe]	75
SYSTem:LOCal	73
SYSTem:OPTion?	74
SYSTem:REMote	73
SYSTem:RWLock	73
SYSTem:TEST:BEEPer	74
SYSTem:TEST:FANCtrl	74
SYSTem:TEST:KEYBacklight	74
SYSTem:TEST:SCReen	74
TRIGger:DIReCtion:DIO<IO>	97
TRIGger:IN:ARBitrary:DIO<IO>	98
TRIGger:IN:RESPonse:DIO<IO>	98
TRIGger:IN:SOURce:DIO<IO>	98
TRIGger:LOGic:DIO<IO>	99
TRIGger:MASTer[:STATe]	99
TRIGger:OUT:CONDition:DIO<IO>	99
TRIGger:OUT:CRITevent:DIO<IO>	100
TRIGger:OUT:CURRlevel:DIO<IO>	100
TRIGger:OUT:SOURce:DIO<IO>	101
TRIGger:OUT:VOLTlevel:DIO<IO>	101
TRIGger:RCL	101
TRIGger:SAV	101
TRIGger[:ENABle]:DIO<IO>	97

Index

A

Activate channel output	40
Activating fuse	41
Advanced commands	
Arbitrary commands	94
DIO commands	97
EasyRamp commands	96

C

Calibration certificate	8
Channel display area	
Operating mode	29
Clear status	
Remote	70
Command sequence	
Remote	72
Command sequence and synchronization	113
Configuration commands	
Channel selecting	76
Combine voltage and current setting	80
Current setting	79
Fuse setting	83
OPP setting	90
Output setting	80
OVP setting	87
Voltage setting	78
Controls	20
Customer support	103

D

Data sheet	8
Default values	
Remote	71
Digital IO	45
Display overview	27
Channel display area	28
Status bar information	27
Documentation overview	7

E

EasyArb	49
EasyRamp	50
Electronic Fuse	41
Event status enable register (ESE)	
Remote	70
Event status register (ESR)	
Remote	71

F

Front panel	
Display	20
Function keys	20
Output channels	20
Power key	20
Rotary knob and arrow keys	20
USB connector	20
Front panel keys	30
Output and channel controls	31
Fuse	42

Fuse delay	42
Fuse linking	42
FuseLink	42

G

General instrument settings	63, 65
Buzzer	65
Display	65
Display brightness	65
Key fallback time	65
Keypad	65
Sound	65
Getting started	8

H

Help	69
------------	----

I

Identification	
Remote	71
Important notes	
Ambient conditions	11
Limits	13
Mains voltage	12
Measurement categories	12
Symbols	11
Information	64
Intended use	7
Interfaces and protocols	54
Network connection	54

M

Maintenance	
Cleaning	103
Menu	33
Menu controls	30
Message and command structure	
Messages	108
SCPI command structure	109
Mode	
Operation modes	37

N

Navigation controls	
Arrow keys	32
Rotary knob	32
Network	
LAN	54
USB	58
Wireless LAN	56

O

On-screen keyboard	36
Open source acknowledgment (OSA)	8
Operation complete	
Remote	71

Operation modes		
Constant current (CC)	38	
Constant voltage (CV)	37	
Options	65	
Identification (remote)	71	
Install option	65	
Installation status	65	
Output and channel controls	31	
P		
Package contents	18	
Power derating	36	
Protection	44	
Overpower protection (OPP)	44	
Overvoltage protection (OVP)	44	
R		
Rear panel		
AC inlet with fuse holder	22	
Digital I/O connector	22	
Ethernet connector	22	
USB connector	22	
Voltage selector	22	
Release notes	8	
Remote control commands		
Advanced commands	93	
Common setting commands	70	
Configuration commands	76	
Data and file management commands	102	
Firmware update commands	102	
Measurement commands	93	
System commands	73	
Reset	66	
Reset values		
Remote	71	
S		
Safety information	7	
Safety instructions	8	
Self-test		
Remote	72	
Service request enable register (SRE)		
Remote	72	
Setting the voltage and current	39	
Setting up the instrument		
Bench operation	18	
Rack mounting	18	
Status bar information		
Channel status bar	28	
Device status bar	27	
Status byte		
Remote	70, 72	
Store and recall	52	
Switching off the instrument	24	
Switching on the instrument	24	
System test	67	
T		
Tracking function	43	
Trying out the instrument		
Activating the channels output	25	
Selecting the channels	25	
Setting the output voltage and Current limit	25	
Storing/Recalling of instrument settings	25	
U		
Unpacking and checking the instrument	18	
Update	68	
User manual	8	
W		
Wait		
Remote	72	